

ABB MACHINERY DRIVES

ACS180 machinery control program Firmware manual



List of related manuals

Drive hardware manuals and guides

Drive/converter/inverter safety instructions	3AXD50000037978
ACS180 Hardware manual	3AXD50000467945

Drive firmware manuals and guides

ACS180 Firmware manual	3AXD50000467860
ACS180 Quick installation and start-up guide	3AXD50000510344
ACS180 User interface guide	3AXD50000606696

Option manuals and guides

ACS-AP-x Assistant control panels user's manual	3AUA0000085685
ACS-BP-S Basic control panel user's manual	3AXD50000032527

Tool and maintenance manuals and guides

Drive composer PC tool user's manual	3AUA0000094606
Converter module capacitor reforming instructions	38FE64059629
Adaptive Programming Application guide	3AXD50000028574

You can find manuals and other product documents in PDF format on the Internet. See section Document library on the Internet on the inside of the back cover. For manuals not available in the Document library, contact your local ABB representative.

The code below opens an online listing of the manuals applicable to the product:



Firmware manual

ACS180 machinery control program

Table of contents



3. Start-up, ID run and use



Table of contents

1. Introduction to the manual

What this chapter contains	11
Applicability	11
Safety instructions	11
Target audience	12
Terms and abbreviations	13
Related manuals	14
Cybersecurity disclaimer	14

2. Control panel

What this chapter contains	15
Control panel	15
Home view and Message view	16
Options menu and Main menu	17
Options menu	17
Main menu	17

3. Start-up, ID run and use

What this chapter contains	21
Start up the drive	21
Do the identification (ID) run	22
Background information	22
ID run steps	23
Start and stop the drive	24
Change the rotation direction	24
Set the speed or frequency reference	24
Set the drive parameters	25
Open Diagnostics	25
Change the units	26

4. Control macros

Contents	27
ABB standard macro	27
Default control connections for the ABB standard macro	28
Hand/Auto macro	30
Default control connections for the Hand/Auto macro	30
Hand/PID macro	32
Default control connections for the Hand/PID macro	32
Modbus RTU macro	34
Default control connections for the Modbus macro	34
3-wire macro	36
Default control connections for the 3-wire macro	36



Alternate macro	38
Default control connections for the Alternate macro	38
Motor potentiometer macro	40
Default control connections for the Motor potentiometer macro	41
PID macro	43
Default control connections for PID control macro	43

5. Program features

What this chapter contains	45
Local and external control locations	46
Local control	46
External control	47
Operating modes of the drive	48
Speed control mode	48
Torque control mode	49
Frequency control mode	49
Special control modes	49
Settings and diagnostics	50
Drive configuration and programming	50
Programming via parameters	50
Adaptive programming	51
Control interfaces	54
Programmable analog inputs	54
Programmable analog outputs	54
Programmable digital inputs and outputs	54
Programmable relay outputs	55
Fieldbus control	55
Motor control	55
Motor types	55
Motor identification	55
Scalar motor control	56
Vector control	57
Reference ramping	57
Constant speeds/frequencies	58
Critical speeds/frequencies	58
Speed controller autotune	59
Rush control	63
Jogging	63
Autophasing	66
Speed control performance figures	67
Torque control performance figures	67
User load curve	68
U/f ratio	69
Flux braking	70
DC magnetization	71
Energy optimization	73
Switching frequency	73
Speed compensated stop	74
Application control	75
Control macros	75



Process PID control	75
PID trim function	77
Mechanical brake control	84
DC voltage control	88
Overvoltage control	88
Undervoltage control (power loss ride-through)	88
Voltage control and trip limits	89
Settings and diagnostics	91
Safety and protections	92
Fixed/Standard protections	92
Emergency stop	92
Motor thermal protection	93
Automatic fault resets	96
Other programmable protection functions	96
Diagnostics	99
Fault and warning messages, data logging	99
Signal supervision	99
Energy saving calculators	99
Load analyzer	100
Miscellaneous	102
Backup and restore	102
User parameter sets	102
Data storage parameters	103
Parameter checksum calculation	103
Motor potentiometer	104
User lock	105
AI dead band	106



6. Parameters

What this chapter contains	107
Terms and abbreviations	108
Fieldbus addresses	108
Summary of parameter groups	109
Parameter listing	111
01 Actual values	111
03 Input references	114
04 Warnings and faults	115
05 Diagnostics	117
06 Control and status words	120
07 System info	126
10 Standard DI, RO	127
11 Standard DIO, FI, FO	132
12 Standard AI	136
13 Standard AO	141
19 Operation mode	145
20 Start/stop/direction	147
21 Start/stop mode	157
22 Speed reference selection	166
23 Speed reference ramp	177
24 Speed reference conditioning	181

25 Speed control	182
26 Torque reference chain	187
28 Frequency reference chain	192
30 Limits	204
31 Fault functions	212
32 Supervision	221
35 Motor thermal protection	234
36 Load analyzer	240
37 User load curve	244
40 Process PID set 1	248
41 Process PID set 2	263
43 Brake chopper	265
44 Mechanical brake control	268
45 Energy efficiency	269
46 Monitoring/scaling settings	274
47 Data storage	277
49 Panel port communication	278
58 Embedded fieldbus	281
71 External PID1	290
95 HW configuration	293
96 System	295
97 Motor control	304
98 User motor parameters	310
99 Motor data	311



Differences in the default values between 50 Hz and 60 Hz supply frequency settings	318
Parameters supported by Modbus backwards compatibility with legacy drives	319

7. Additional parameter data

What this chapter contains	323
Terms and abbreviations	323
Fieldbus addresses	324
Parameter groups 1...9	325
Parameter groups 10...99	329

8. Fault tracing

What this chapter contains	353
Safety	353
Indications	354
Warnings and faults	354
Pure events	354
Warning/fault history	354
Event log	354
Viewing warning/fault information	355
QR Code generation for mobile service application	355
Warning messages	356
Fault messages	366

9. Fieldbus control through the embedded fieldbus interface (EFB)

What this chapter contains	377
System overview	378
Modbus	378
Embedded fieldbus and external control panel mode switch	378
Connecting the fieldbus to the drive	378
Setting up the embedded fieldbus interface (Modbus)	379
Setting the drive control parameters	382
Basics of the embedded fieldbus interface	384
Control word and Status word	384
References	385
Actual values	385
Data input/outputs	385
Register addressing	385
About the control profiles	386
Control Word	387
Control Word for the DCU Profile	388
Status Word	390
State transition diagrams	393
References	395
Actual values	396
Modbus holding register addresses	397
Modbus function codes	398
Exception codes	399
Coils (0xxxx reference set)	400
Discrete inputs (1xxxx reference set)	401
Error code registers (holding registers 400090...400100)	402



10. Control chain diagrams

What this chapter contains	405
Frequency reference selection	406
Frequency reference modification	407
Speed reference source selection I	408
Speed reference source selection II	409
Speed reference ramping and shaping	410
Speed error calculation	411
Speed controller	412
Torque reference source selection and modification	413
Reference selection for torque controller	414
Torque limitation	415
Process PID setpoint and feedback source selection	416
Process PID controller	417
External PID setpoint and feedback source selection	418
External PID controller	419
Direction lock	420



1

Introduction to the manual

What this chapter contains

- *Applicability*
- *Safety instructions*
- *Target audience*
- *Terms and abbreviations*
- *Related manuals*



Applicability

The manual applies to the ACS180 machinery control program 2.16 or later.

To check the version of the control program, see parameter *07.05 Firmware version*.

Safety instructions

Follow all safety instructions.

- Read the complete safety instructions in the Hardware manual of the drive before you install, commission, or use the drive.
 - Read the firmware function-specific warnings before changing parameter values. Chapter *Parameters* lists the relevant parameters and related warnings.
-

Target audience

The reader is expected to know the fundamentals of electricity, wiring, electrical components and electrical schematic symbols.

The manual is written for readers worldwide. Both SI and imperial units are shown.



Terms and abbreviations

Term/abbreviation	Explanation
ACS-AP-x	Assistant control panel, advanced operator keypad for communication with the drive. The ACS180 support types ACS-AP-I, ACS-AP-S and ACS-AP-W (with a Bluetooth interface).
ACS-BP-S	Basic control panel, basic operator keypad for communication with the drive.
AI	Analog input; interface for analog input signals
AO	Analog output; interface for analog output signals
AsynM	Asynchronous motor
BCBL-01	Optional USB to RJ45 cable
Capacitor bank	See <i>DC link capacitors</i> .
Control board	Circuit board in which the control program runs
DC link	DC circuit between rectifier and inverter
DC link capacitors	Energy storage which stabilizes the intermediate circuit DC voltage
DI	Digital input; interface for digital input signals
DO	Digital output; interface for digital output signals
Drive	Frequency converter for controlling AC motors
EFB	Embedded fieldbus
Frame (size)	Refers to the drive physical size, for example R0 and R1. The type designation label attached to the drive shows the frame of the drive, see the hardware manual of the drive.
ID run	Motor identification run. During the identification run, the drive will identify the characteristics of the motor for optimum motor control.
Hexadecimal	Describes binary numbers using a numbering system that has 16 sequential numbers as base units. The hexadecimal numbers are 0-9 and the letters A-F.
IGBT	Insulated gate bipolar transistor
Intermediate circuit	See <i>DC link</i> .
Inverter	Converts direct current and voltage to alternating current and voltage.
I/O	Input/Output
LSW	Least significant word
Macro	Pre-defined default values of parameters in a drive control program. Each macro is intended for a specific application. See chapter <i>Control macros</i> .
NETA-21	Optional remote monitoring tool
Parameter	User-adjustable operation instruction to the drive, or signal measured or calculated by the drive



PID controller	Proportional–integral–derivative controller
PLC	Programmable logic controller
PMSM	Permanent magnet synchronous motor
PM	Permanent magnet
RO, R1,...	Frame (size)
RCD	Residual current device
Rectifier	Converts alternating current and voltage to direct current and voltage.
RFI	Radio frequency interference
RO	Relay output; interface for a digital output signal. Implemented with a relay.
SIL	Safety integrity level. See chapter <i>Safe torque off function</i> in the drive hardware manual.
STO	Safe torque off. See chapter <i>Safe torque off function</i> in the drive hardware manual.

Related manuals

The related manuals are listed behind the front cover under *List of related manuals*.



Cybersecurity disclaimer

This product is designed to be connected to and to communicate information and data via a network interface. It is Customer's sole responsibility to provide and continuously ensure a secure connection between the product and Customer network or any other network (as the case may be). Customer shall establish and maintain any appropriate measures (such as but not limited to the installation of firewalls, application of authentication measures, encryption of data, installation of anti-virus programs, etc) to protect the product, the network, its system and the interface against any kind of security breaches, unauthorized access, interference, intrusion, leakage and/or theft of data or information. ABB and its affiliates are not liable for damages and/or losses related to such security breaches, any unauthorized access, interference, intrusion, leakage and/or theft of data or information.

See also section *User lock* (page 105).

2

Control panel

What this chapter contains

- *Control panel*
- *Home view and Message view*
- *Options menu*
- *Main menu*

Control panel

By default, ACS 180 has an integrated panel. If required, you can use external control panels such as assistant control panel or a basic panel. For more information, refer *ACX-AP-x assistant control panel's user's manual* (3AUA0000085685 [English]) or *ACS-BP-S basic control panel's user's manual* (3AXD50000032527 [English]).

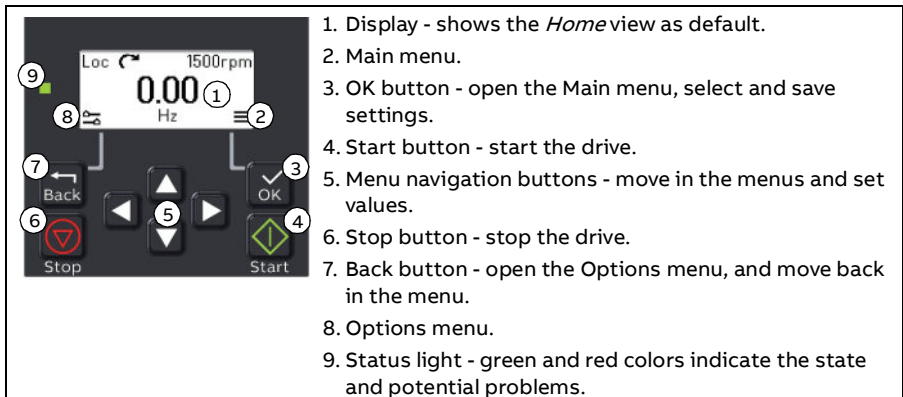

Home view and Message view

The *Home* view is the main view. Open the Main menu and Options menu from the *Home* view.

Home view



1. Control selection - local or remote
2. Local start/stop control - enabled
3. Rotation direction - forward or reverse
4. Local reference setting - enabled
5. Speed - target
6. Speed - current
7. Main menu - menu list
8. Options menu - quick access menu

The screenshot shows a control panel with the following elements: a 'Loc' button with a circular arrow icon (1), a start/stop control with a play/pause icon (2), a rotation direction control with a curved arrow icon (3), a local reference setting control with a plus/minus icon (4), a target speed display showing '1501rpm' (5), a large current speed display showing '1499.50' (6), a main menu icon (three horizontal lines) (7), and an options menu icon (a square with a circle) (8). The unit 'rpm' is displayed below the speed displays.

The *Message* view shows fault and warning messages. If there is an active fault or warning, the panel shows the *Message* view directly.

You can open the *Message* view from the Options menu or Diagnostics submenu.

Message view: Fault



Fault messages require your immediate attention.

Check the code in the Fault messages table on page 366 to troubleshoot the problem.

The screenshot shows a fault message screen with a large 'X' icon, the code '1001', and the text 'Reset?'. Above the code, it displays 'Loc' with a circular arrow icon and '1500rpm'.

Message view: Warning



Warning messages show possible problems.

Check the code in the Warning messages table on page 356 to troubleshoot the problem.

The screenshot shows a warning message screen with three warning icons (triangles with exclamation marks) and the text 'Warning: 2009'. Above the warnings, it displays 'Loc' with a circular arrow icon and '1500rpm'.

Options menu and Main menu

Options menu

1.To open: press the Back button in the Home view.



Main menu

2.To open: press the OK button in the Home view.

Options menu

The Options menu is a quick access menu.

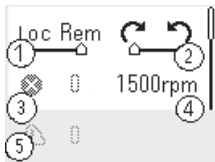

1. Control location - set to local or remote control
2. Rotation direction - set to forward or reverse
3. Active faults - view possible faults
4. Reference speed - set the reference speed
5. Active warnings - view possible warnings

Main menu

The Main menu is a scroll menu. The menu icons represent specific groups. The groups have submenus.

Note: You can define which Main menu items are visible (see parameter *49.30*).



1. Motor data - motor parameters
2. Motor control - motor settings
3. Control macros
4. Diagnostics - faults, warnings, fault log and connection status
5. Parameters - parameters

Submenus

The Main menu items have submenus. Some submenus also have menus and/or option lists. The content of the submenu depend on the drive type.

Motor Data



1. AsynM	Scalar	2
3. 75kW	1.90A	4
5. 400.0V	50.0Hz	6
7. 460rpm	50.0Nm	8
9. U V W	Cosφ	10
11. 50 Hz, kW, °C	0.00	

1. Motor type - AsynM, PMSM
2. Control mode - Scalar, Vector
3. Nominal power
4. Nominal current
5. Nominal voltage
6. Nominal frequency
7. Nominal speed
8. Nominal torque
9. Phase order - U V W, U W V
10. Nominal Cosphi
11. Unit selection - SI or US units

Motor Data: Motor type

AsynM	PMSM
1	2

1. AsynM
2. PMSM

Motor Data: Control mode

Scalar	Vector
1	2

1. Scalar
2. Vector

Motor Data: Phase order

U V W	U W V
1	2

1. U V W
2. U W V

Motor Data: Unit selection

50 Hz, kW, °C	60 Hz, hp, °F
1	2

1. SI units
2. US units

Motor Control



1. Start mode - Const time, Automatic
2. Stop mode - Coast, Ramp, DC hold
3. Acceleration time
4. Deceleration time
5. Maximum allowed speed
6. Maximum allowed current
7. Minimum allowed speed

Motor Control: Start modes

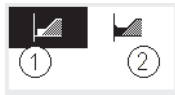

1. Const time
2. Automatic

Motor Control: Stop modes

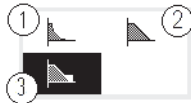

1. Coast
2. Ramp
3. DC hold

Control macros

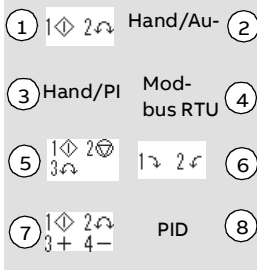

1. ABB standard
2. Hand/Auto
3. Hand/PID
4. Modbus RTU
5. 3-wire
6. Alternate
7. Motor potentiometer
8. PID

Diagnostics



1. Active Fault - shows the fault code
2. Fault History - list of latest fault codes (newest first)
3. Active Warnings - shows the warning code
4. Connection Status - Fieldbus and I/O signals

Parameters



1. Complete parameter list - groups menu with complete parameters and parameter levels
2. Modified parameter list
3. Parameter restore - reset to factory default parameters

3

Start-up, ID run and use

What this chapter contains

- *Start up the drive*
- *Do the identification (ID) run*
- *Start and stop the drive*
- *Change the rotation direction*
- *Set the speed or frequency reference*
- *Set the drive parameters*
- *Open Diagnostics*
- *Change the units*



Note: In this chapter the drive uses an integrated panel to perform the start-up, ID run, and other actions. You can also perform these functions using an external control panel or a drive composer PC tool.

Start up the drive

1. Power up the drive.
2. Select the unit (international or US) and press OK.
3. In the *Motor data* view, set the motor type:

AsynM: Asynchronous motor

PMSM: Permanent magnet motor

4. Set the motor control mode:

Vector: Speed reference. This is suitable for most cases. The drive does an automatic stand-still ID run.

Scalar: Frequency reference.

Use this mode when:

-The number of motors can change.

-The nominal motor current is less than 20% of the nominal drive current.

Scalar mode is not recommended for permanent magnet motors.

5. Set the nominal motor values:

- Nominal power
- Nominal current
- Nominal voltage
- Nominal frequency
- Nominal speed
- Nominal torque (optional)
- Nominal cosphi (optional)

6. Examine the direction of the motor.

If it is necessary, set the motor direction with the **Phase order** setting or with the phase order of the motor cable.

 **7.** In the *Motor control* view, set the start and stop mode.

8. Set the acceleration time and the deceleration time.

Note: The speed acceleration and deceleration ramp times are based on the value in parameter *46.01 Speed scaling*/*46.02 Frequency scaling*.

9. Set the maximum and minimum speed or frequency. For more information, see parameters *30.11 Minimum speed* / *30.13 Minimum frequency* and *30.12 Maximum speed*/*30.14 Maximum frequency* on page 207.

10. In the *Control macros* view, select the applicable macro.

11. Tune the drive parameters to the application. You can use the Assistant control panel (ACS-AP-x), or the Drive Composer PC tool with the drive.

Do the identification (ID) run

■ Background information

The drive automatically estimates motor characteristics using Standstill ID run when the drive is started for the first time, and after any motor parameter (group *99 Motor data*) is changed. This is valid when:

- parameter *99.13 ID run requested* selection is *Standstill* and
 - parameter *99.04 Motor control mode* selection is *Vector*.
-

In most applications there is no need to perform a separate ID run. Select the ID run for demanding motor control connections. For example:

- permanent magnet motor (PMSM) is used
- drive operates near zero speed references, or
- operation at torque range above the motor nominal torque, over a wide speed range is needed.

Note: If you change the motor parameters after the ID run, you need to repeat the run.

Note: If you have already parameterized your application using scalar motor control mode and you need to change to vector:

- Set parameter *99.04 Motor control mode selection* to *Vector*.
- for I/O controlled drive, check parameters in groups *22 Speed reference selection*, *23 Speed reference ramp*, *12 Standard AI*, *30 Limits* and *46 Monitoring/scaling settings*.
- for torque controlled drive, check also parameters in group *26 Torque reference chain*.

■ ID run steps



Warning! Make sure it is safe to run the procedure.

1. Open the *Main* menu.
2. Select the *Parameters* submenu.
3. Select *All parameters*.
4. Select *99 Motor data* and press OK.
5. Select *99.13 ID run requested*, select the wanted ID mode and press OK.
An *AFF6 Identification run* warning message is shown before you press Start.
The panel LED starts to blink green to indicate an active warning.
6. Press Start to start the ID run.
Do not to press any control panel keys during the ID run. If you need to stop the ID run, press Stop.
After the ID run is completed, the status light stops blinking.

If the ID run fails, the panel shows the fault *FF61 ID run*.



Start and stop the drive



1. Press the Start button to start the drive.
2. Press the Stop button to stop the drive.

Change the rotation direction



1. On *Home* view, press Back button to get *Options* menu.
2. In the *Options* menu, move to the rotation direction item and press OK. Then use the arrow buttons to change the rotation direction selection.
3. Press the OK button to change the rotation direction.

Set the speed or frequency reference

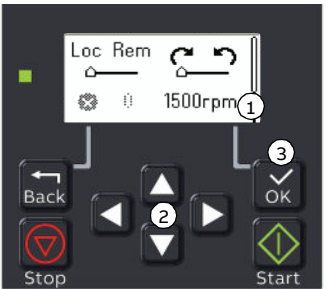

1. On *Home* view, press Back button to get *Options* menu.
2. In the *Options* menu, move to the speed or frequency reference item and press OK.
3. Press the arrow buttons to edit the value.
4. Press the OK button to confirm the new value.

Set the drive parameters

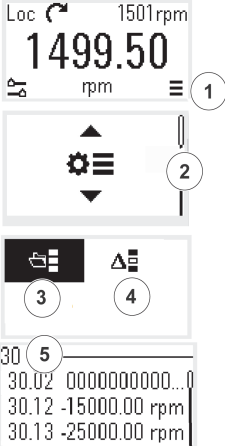

The screenshot shows a sequence of four screens from a drive's user interface. The first screen displays 'Loc' with a refresh icon, '1501rpm', and a large '1499.50' with 'rpm' below it. A menu icon (three horizontal lines) is on the right, with a circled '1' next to it. The second screen shows a gear icon and a menu icon, with a vertical scroll bar on the right and a circled '2' next to it. The third screen shows two icons: a list icon and a warning icon, with circled '3' and '4' next to them. The fourth screen shows a list of parameters: '30' (with a circled '5'), '30.02 00000000000...0', '30.12 -15000.00 rpm', and '30.13 -25000.00 rpm'.

1. Select the Main menu from the *Home* view (by pressing OK button).
2. Scroll to Parameters, and press the OK button to open the submenu.
3. Select the complete parameters list with the arrow button and press the OK button, or
4. Select the modified parameters list with the arrow button and press the OK button.
5. Select the parameter and press the OK button to adjust the value.

The parameters are shown in respective groups. The first two digits of the parameter number represent the parameter group. For example, parameters starting with 30 are in the Limits group.

See chapter *Parameters* for more information.

Open Diagnostics

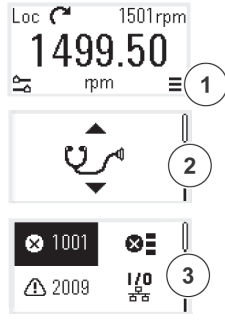

The screenshot shows a sequence of three screens from a drive's user interface. The first screen is identical to the one in the 'Set the drive parameters' section, with a circled '1' next to the menu icon. The second screen shows a warning icon (a lightning bolt in a circle) and a menu icon, with a vertical scroll bar on the right and a circled '2' next to it. The third screen shows two warning icons: '1001' (with a circled '3') and '2009', with a menu icon to the right.

1. Select the Main menu from the *Home* view (by pressing OK button).
2. Scroll to Diagnostics and press the OK button to open the submenu.
3. Select the warning or fault with the arrow button and press the OK button.

See chapter *Fault tracing* for more information.



Change the units

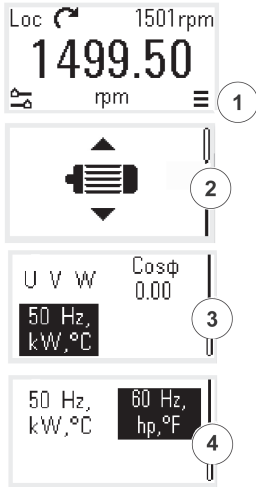

1. Select the Main menu from the *Home* view (by pressing OK button).
2. Scroll to Motor data and press the OK button to open the submenu.
3. Scroll to the unit selection item and press the OK button.
4. Select the unit set with the arrow button, then press the OK button.

4

Control macros

Contents

- *ABB standard macro*
- *Hand/Auto macro*
- *Hand/PID macro*
- *Modbus RTU macro*
- *3-wire macro*
- *Motor potentiometer macro*
- *PID macro*

Control macros are sets of default parameter values that apply to a specific control configuration. They make it faster and easier to set up a drive for use.

By default, macro is set as ABB standard macro.

ABB standard macro

ABB standard macro is suitable for an I/O-controlled drive. Digital inputs control start/stop (2-wire), direction and constant speed selection (3 speeds).

You can activate the macro from the *Control macros* view, or by setting parameter *96.04 Macro select* to value *ABB standard*.

This is the default macro for drive ACS180-04.

■ Default control connections for the ABB standard macro

Terminals		Descriptions
Digital I/O connections		
21	24 V	Aux. +24 V DC, max 200 mA
22	DGND	Aux. voltage output common
8	DI1	Stop (0) / Start (1)
9	DI2	Forward (0) / Reverse (1)
10	DI3	Constant speed selection ¹⁾
11	DI4	Constant speed selection ¹⁾
12	DCOM	Digital input common
18	DO	Running
19	DO COM	Digital output common
20	DO SRC	Digital output auxiliary voltage
Analog I/O		
14	AI1/DI5	Speed reference (0...10V) ²⁾
13	AGND	Analog input circuit common
15	AI2	Not used ²⁾
16	AGND	Analog output circuit common
17	AO	Output frequency (0...20mA) ²⁾
23	10V	Ref. voltage +10 V DC
24	SCREEN	Signal cable shield (screen)
Safe torque off (STO)		
1	S+	Safe torque off function. Connected at the factory. Drive starts only when both circuits are closed.
2	SGND	
3	S1	
4	S2	
Relay output		
5	NC	No fault [Fault (-1)]
6	COM	
7	NO	
EIA-485 Modbus RTU		
25	B+	Embedded Modbus RTU (EIA-485)
26	A-	
27	AGND	
28	SHIELD	
Jumper		
J1	Termination	Modbus termination selection
J2	Comm.Mode	Communication mode selection

Terminal sizes: 0.5 mm² ... 1 mm²

Notes:

- 1) In scalar control (default): See parameter group *28 Frequency reference chain*.
In vector control: See parameter group *22 Speed reference selection*.

Select the correct control mode from the *Motor data* view or with parameter *99.04 Motor control mode*.

D13	D14	Operation/Parameter	
		Scalar control (default)	Vector control
0	0	Set frequency through AI1	Set speed through AI1
1	0	<i>28.26 Constant frequency 1</i>	<i>22.26 Constant speed 1</i>
0	1	<i>28.27 Constant frequency 2</i>	<i>22.27 Constant speed 2</i>
1	1	<i>28.28 Constant frequency 3</i>	<i>22.28 Constant speed 3</i>

- 2) Ground the outer shield of the cable 360 degrees under the grounding clamp on the grounding shelf for the control cables.
- 3) Select voltage or current for inputs AI1 and AI2 and output AO with parameters *12.15*, *12.25* and *13.15*, respectively.

Input signals

- Analog frequency reference (AI1)
- Start/stop selection (DI1)
- Direction selection (DI2)
- Constant frequency selection (DI3)
- Constant frequency selection (DI4)

Output signals

- Digital output: Running
 - Relay output: No fault [Fault (-1)]
 - Analog output AO: Output frequency
-

Hand/Auto macro

This macro can be used when switching between two external control devices is needed. Both have their own control and reference signals. One signal is used to switch between these two. You can activate the macro from the *Control macros* view, or set parameter *96.04 Macro select* to *Hand/Auto*.

■ Default control connections for the Hand/Auto macro

Terminals	Descriptions	
Digital I/O connections		
21	24 V	Aux. +24 V DC, max 200 mA
22	DGND	Aux. voltage output common
8	DI1	Stop / Start (Hand)
9	DI2	Hand(1) / Auto(0)
10	DI3	Stop / Start (Auto)
11	DI4	Fault reset
12	DCOM	Digital input common
18	DO	Running
19	DO COM	Digital output common
20	DO SRC	Digital output auxiliary voltage
Analog I/O		
14	AI1/DI5	Speed reference (Hand) (0...10V) ²⁾
13	AGND	Analog input circuit common
15	AI2	Speed reference (Auto) (4...20mA) ²⁾
16	AGND	Analog output circuit common
17	AO	Output frequency (0...20mA) ²⁾
23	10V	Ref. voltage +10 V DC
24	SCREEN	Signal cable shield (screen)
Safe torque off (STO)		
1	S+	Safe torque off function. Connected at the factory. Drive starts only when both circuits are closed.
2	SGND	
3	S1	
4	S2	
Relay output		
5	NC	No fault [Fault (-1)]
6	COM	
7	NO	
EIA-485 Modbus RTU		
25	B+	Embedded Modbus RTU (EIA-485)
26	A-	
27	AGND	
28	SHIELD	
Jumper		
J1	Termination	Modbus termination selection
J2	Comm.Mode	Communication mode selection

Terminal sizes: 0.5 mm² ... 1 mm²

Notes:

- 1) Ground the outer shield of the cable 360 degrees under the grounding clamp on the grounding shelf for the control cables.
- 2) Select voltage or current for inputs AI1 and AI2 and output AO with parameters *12.15*, *12.25* and *13.15*, respectively.

Input signals

- Speed analog reference, Hand (AI1)
- Speed analog reference, Auto (AI2)
- Start/stop selection, Hand (DI1)
- Hand(1)/Auto(0) selection (DI2)
- Start/stop selection, Auto (DI3)
- Fault reset (DI4)

Output signals

- Digital output: Running
 - Relay output: Fault(-1)
 - Analog output AO: Output frequency
-

Hand/PID macro

This macro controls the drive with the built-in process PID controller. In addition this macro has a second control location for the direct speed/frequency control mode. You can activate the macro from the *Control macros* view, or set parameter *96.04 Macro select* to *Hand/Auto*.

■ Default control connections for the Hand/PID macro

Terminals	Descriptions	
Digital I/O connections		
21	24 V	Aux. +24 V DC, max 200 mA
22	DGND	Aux. voltage output common
8	DI1	Start/Stop (Hand)
9	DI2	Hand(1)/PID(0)
10	DI3	Start/Stop (PID)
11	DI4	Constant speed selection 1 ³⁾
12	DCOM	Digital input common
18	DO	Running
19	DO COM	Digital output common
20	DO SRC	Digital output auxiliary voltage
Analog I/O		
14	AI1/DI5	Hand mode speed ref. (AI1,0...10V) ^{1),5)}
13	AGND	Analog input circuit common
15	AI2	Process feedback (4...20mA) ^{1),2),5)}
16	AGND	Analog output circuit common
17	AO	Output frequency (0...20mA) ⁵⁾
23	10V	Ref. voltage +10 V DC
24	SCREEN	Signal cable shield (screen)
Safe torque off (STO)		
1	S+	Safe torque off function. Connected at the factory. Drive starts only when both circuits are closed.
2	SGND	
3	S1	
4	S2	
Relay output		
5	NC	No fault [Fault (-1)]
6	COM	
7	NO	
EIA-485 Modbus RTU		
25	B+	Embedded Modbus RTU (EIA-485)
26	A-	
27	AGND	
28	SHIELD	
Jumper		
J1	Termination	Modbus termination selection
J2	Comm.Mode	Communication mode selection

Terminal sizes: 0.5 mm² ... 1 mm²

Notes:

- 1) Hand: 0...10 V -> frequency reference.
PID: 4...20 mA -> 0...100% PID Process feedback.
- 2) The signal source is powered externally. See the manufacturer's instructions. To use sensors supplied by the drive aux. voltage output, see chapter *Electrical installation*, section *Connection examples of two-wire and three-wire sensors* in the *Hardware manual* of the drive.
- 3) In scalar control (default): See the *Control macros* view or parameter group *28 Frequency reference chain*.

DI4	Operation (parameter)
	Scalar control (default)
0	Set frequency through AI1
1	<i>28.26 Constant frequency 1</i>

- 4) Ground the outer shield of the cable 360 degrees under the grounding clamp on the grounding shelf for the control cables.
- 5) Select voltage or current for inputs AI1 and AI2 and output AO with parameters *12.15*, *12.25* and *13.15*, respectively.

Input signals

- Hand mode speed analog reference (AI1)
- Process feedback (AI2)
- Start/Stop selection, Hand (DI1)
- Hand(1)/PID(0) selection (DI2)
- Start/Stop selection, PID (DI3)
- Constant speed selection 1 (DI4)

Output signals

- Digital output: Running
 - Relay output: Fault(-1)
 - Analog output AO: Output frequency
-

Notes:

Set the communication mode jumper to Modbus Mode. EIA-485 Modbus RTU can't be used together with external panel.

Input signals

- Constant speed selection 1 (AI1)
- Speed reference, Hand (AI2)
- Start/stop selection, Hand (DI1)
- Forward/Reverse selection, Hand (DI2)
- Hand(1)/Modbus(0) selection (DI3)
- Fault reset (DI4)

Output signals

- Digital output: Running
 - Relay output: Fault(-1)
 - Analog output AO: Output frequency
-

3-wire macro

This macro is used when the drive is controlled using momentary push-buttons. It provides three constant speeds. You can activate the macro from the Control macros view, or set parameter *96.04 Macro select* to *3-wire*.

■ Default control connections for the 3-wire macro

Terminals		Descriptions
Digital I/O connections		
21	24 V	Aux. +24 V DC, max 200 mA
22	DGND	Aux. voltage output common
8	DI1	Start (pulse \bar{f})
9	DI2	Stop (0)
10	DI3	Forward (0) / Reverse (1)
11	DI4	Constant speed/frequency selection ²⁾
12	DCOM	Digital input common
18	DO	Running
19	DO COM	Digital output common
20	DO SRC	Digital output auxiliary voltage
Analog I/O		
14	AI1/DI5	Constant speed/frequency selection ^{2,5)}
13	AGND	Analog input circuit common
15	AI2	Ext. frequency ref1: 0...10 V ^{1,4)}
16	AGND	Analog output circuit common
17	AO	Output frequency (0...20 mA) ⁶⁾
23	10V	Ref. voltage +10 V DC
24	SCREEN	Signal cable shield (screen)
Safe torque off (STO)		
1	S+	Safe torque off function. Connected at the factory. Drive starts only when both circuits are closed.
2	SGND	
3	S1	
4	S2	
Relay output		
5	NC	No fault [Fault (-1)]
6	COM	
7	NO	
EIA-485 Modbus RTU		
25	B+	Embedded Modbus RTU (EIA-485)
26	A-	
27	AGND	
28	SHIELD	
Jumper		
J1	Termination	Modbus termination selection
J2	Comm.Mode	Communication mode selection

Terminal sizes: 0.5 mm² ... 1 mm²

Notes:

- 1) AI2 is used as a speed reference if vector control is selected.
- 2) In scalar control (default): See parameter group *28 Frequency reference chain*.
In vector control: See parameter group *22 Speed reference selection*.

DI4	DI5	Operation/Parameter	
		Scalar control (default)	Vector control
0	0	Set frequency through AI2	Set speed through AI2
1	0	<i>28.26 Constant frequency 1</i>	<i>22.26 Constant speed 1</i>
0	1	<i>28.27 Constant frequency 2</i>	<i>22.27 Constant speed 2</i>
1	1	<i>28.28 Constant frequency 3</i>	<i>22.28 Constant speed 3</i>

- 3) Ground the outer shield of the cable 360 degrees under the grounding clamp on the grounding shelf for the control cables.
- 4) Select voltage mode for inputs AI2 with parameter *12.25*.
- 5) Select digital input mode for input AI1/DI5 terminal with parameter *11.21*.
- 6) Select voltage or current for output AO with parameter *13.15*.

Input signals

- Speed/frequency reference (AI2)
- Start, rising edge (DI1)
- Stop (0) (DI2)
- Direction selection (DI3)
- Constant speed/frequency selection (DI4, DI5)

Output signals

- Digital output: Running
 - Relay output: No fault [Fault (-1)]
 - Analog output AO: Output frequency
-

Alternate macro

This macro provides an I/O configuration where one signal starts the motor in the forward direction and another signal starts the motor in the reverse direction.

You can activate the macro from the *Control macros* view, or by setting parameter *96.04 Macro select* to value *Alternate*.

■ Default control connections for the Alternate macro

Terminals	Descriptions		
	Digital I/O connections		
	21	24 V	Aux. +24 V DC, max 200 mA
	22	DGND	Aux. voltage output common
	8	DI1	Start forward
	9	DI2	Start reverse
	10	DI3	Constant speed selection 1 ²⁾
	11	DI4	Constant speed selection 2 ²⁾
	12	DCOM	Digital input common
	18	DO	Running
	19	DO COM	Digital output common
	20	DO SRC	Digital output auxiliary voltage
	Analog I/O		
	14	AI1/DI5	Fault reset ³⁾
	13	AGND	Analog input circuit common
	15	AI2	Speed reference (0...10 V) ³⁾
	16	AGND	Analog output circuit common
	17	AO	Output frequency (0...20 mA) ³⁾
	23	10V	Ref. voltage +10 V DC
	24	SCREEN	Signal cable shield (screen)
	Safe torque off (STO)		
	1	S+	Safe torque off function. Connected at the factory. Drive starts only when both circuits are closed.
	2	SGND	
	3	S1	
	4	S2	
Relay output			
5	NC	No fault [Fault (-1)]	
6	COM		
7	NO		
EIA-485 Modbus RTU			
25	B+	Embedded Modbus RTU (EIA-485)	
26	A-		
27	AGND		
28	SHIELD		
Jumper			
J1	Termination	Modbus termination selection	
J2	Comm.Mode	Communication mode selection	

Terminal sizes: 0.5 mm² ... 1 mm²

Notes:

- 1) In scalar control (default): See parameter group *28 Frequency reference chain*.
In vector control: See parameter group *22 Speed reference selection*.

Select the correct control mode from the *Motor data* view or with parameter *99.04 Motor control mode*.

DI3	DI4	Operation/Parameter	
		Scalar control (default)	Vector control
0	0	Set frequency through AI1	Set speed through AI1
1	0	<i>28.26 Constant frequency 1</i>	<i>22.26 Constant speed 1</i>
0	1	<i>28.27 Constant frequency 2</i>	<i>22.27 Constant speed 2</i>
1	1	<i>28.28 Constant frequency 3</i>	<i>22.28 Constant speed 3</i>

- 2) Ground the outer shield of the cable 360 degrees under the grounding clamp on the grounding shelf for the control cables.
- 3) Select voltage or current for input AI2 and output AO with parameters *12.25* and *13.15*, respectively.

Input signals

- Fault reset (DI5)
- Speed analog reference (AI2)
- Start forward (DI1)
- Start reverse (DI2)
- Constant speed selection 1 (DI3)
- Constant speed selection 2 (DI4)

Output signals

- Digital output: Running
 - Relay output: Fault(-1)
 - Analog output AO: Output frequency
-

Motor potentiometer macro

This macro provides a way to adjust the speed with the help of two push buttons, or a cost-effective interface for PLCs that vary the speed of the motor using only digital signals.

You can activate the macro from the *Control macros* view, or by setting parameter *96.04 Macro select* to value *Motor potentiometer*.

For more information on the motor potentiometer counter, see section *Motor potentiometer* on page 104.

■ Default control connections for the Motor potentiometer macro

Terminals		Descriptions
Digital I/O connections		
21	24 V	Aux. +24 V DC, max 200 mA
22	DGND	Aux. voltage output common
8	DI1	Start / Stop
9	DI2	Forward / Reverse
10	DI3	Speed reference up ¹⁾
11	DI4	Speed reference down ¹⁾
12	DCOM	Digital input common
18	DO	Running
19	DO COM	Digital output common
20	DO SRC	Digital output auxiliary voltage
Analog I/O		
14	AI1/DI5	Constant speed selection 1(DI5) ^{2, 4)}
13	AGND	Analog input circuit common
15	AI2	Not used ⁴⁾
16	AGND	Analog output circuit common
17	AO	Output frequency (0...20mA) ⁴⁾
23	10V	Ref. voltage +10 V DC
24	SCREEN	Signal cable shield (screen)
Safe torque off (STO)		
1	S+	Safe torque off function. Connected at the factory. Drive starts only when both circuits are closed.
2	SGND	
3	S1	
4	S2	
Relay output		
5	NC	No fault [Fault (-1)]
6	COM	
7	NO	
EIA-485 Modbus RTU		
25	B+	Embedded Modbus RTU (EIA-485)
26	A-	
27	AGND	
28	SHIELD	
Jumper		
J1	Termination	Modbus termination selection
J2	Comm.Mode	Communication mode selection

Terminal sizes: 0.5 mm² ... 1 mm²

Notes:

¹⁾ When the input signal is on, the speed/frequency increase or decrease along a parameter-defined change rate. See parameters 22.75, 22.76, and 22.77. If DI3 and DI4 are both active or inactive, the frequency/speed reference is unchanged. The existing frequency/speed reference is stored during stop and power down.

- 2) In scalar control (default): See parameter group *28 Frequency reference chain*.
In vector control: See parameter group *23 Speed reference ramp*.

Select the correct control mode from the *Motor data* view or with parameter *99.04 Motor control mode*.

AI1/DI5	Operation/Parameter	
	Scalar control (default)	Vector control
0	Set frequency through AI1	Set speed through AI1
1	<i>28.26 Constant frequency 1</i>	<i>22.26 Constant speed 1</i>

- 3) Ground the outer shield of the cable 360 degrees under the grounding clamp on the grounding shelf for the control cables.
- 4) Select voltage or current for inputs AI1 and AI2 and output AO with parameters *12.15*, *12.25* and *13.15*, respectively.

Input signals

- Constant speed selection 1 (DI5)
- Not used (AI2)
- Start/stop selection (DI1)
- Forward/Reverse selection (DI2)
- Speed reference up (DI3)
- Speed reference down (DI4)

Output signals

- Digital output: Running
- Relay output: Fault(-1)
- Analog output AO: Output frequency

PID macro

This macro is suitable for applications where the drive is always controlled by PID and the reference comes from analog input AI1.

You can activate the macro from the *Control macros* view, or by setting parameter *96.04 Macro select* to value *PID*.

■ Default control connections for PID control macro

Terminals	Descriptions
Digital I/O connections	
21 24 V	Aux. +24 V DC, max 200 mA
22 DGND	Aux. voltage output common
8 DI1	Start/Stop
9 DI2	Internal setpoint selection 1 ¹⁾
10 DI3	Internal setpoint selection 2 ²⁾
11 DI4	Constant speed selection (1) ²⁾
12 DCOM	Digital input common
18 DO	Running
19 DO COM	Digital output common
20 DO SRC	Digital output auxiliary voltage
Analog I/O	
14 AI1/DI5	PID set point (AI1, 0...10V) ^{3),6)}
13 AGND	Analog input circuit common
15 AI2	Process feedback (4...20mA) ^{4),6)}
16 AGND	Analog output circuit common
17 AO	Output frequency (0...20mA) ⁶⁾
23 10V	Ref. voltage +10 V DC
24 SCREEN	Signal cable shield (screen)
Safe torque off (STO)	
1 S+	Safe torque off function. Connected at the factory. Drive starts only when both circuits are closed.
2 SGND	
3 S1	
4 S2	
Relay output	
5 NC	No fault [Fault (-1)]
6 COM	
7 NO	
EIA-485 Modbus RTU	
25 B+	Embedded Modbus RTU (EIA-485)
26 A-	
27 AGND	
28 SHIELD	
Jumper	
J1 Termination	Modbus termination selection
J2 Comm.Mode	Communication mode selection

Terminal sizes: 0.5 mm² ... 1 mm²

Notes:

1) See parameters *40.19 Set 1 internal setpoint sel1* and *40.20 Set 1 internal setpoint sel2* source table.

Source defined by par. 40.19 DI2	Source defined by par. 40.20 DI3	Internal setpoint active
0	0	Setpoint source: AI1 (par. 40.16)
1	0	Internal setpoint 1 (par. 40.21)
0	1	Internal setpoint 2 (par. 40.22)
1	1	Internal setpoint 3 (par. 40.23)

2) Select the correct control mode from the *Motor data* view or with parameter *99.04 Motor control mode*.

DI4	Operation/Parameter	
	Scalar control (default)	Vector control
0	Set frequency through AI1	Set speed through AI1
1	<i>28.26 Constant frequency 1</i>	<i>22.26 Constant speed 1</i>

3) PID: 0...10 V -> 0...100% PID setpoint.

4) The signal source is powered externally. See the manufacturer's instructions. To use sensors supplied by the drive aux. voltage output, see connection examples of two-wire and three-wire sensors in the hardware manual of the drive.

5) Ground the outer shield of the cable 360 degrees under the grounding clamp on the grounding shelf for the control cables.

6) Select the unit for analog input AI1 in the parameter *12.15* and for AI2 in the parameter *12.25*.

Input signals

- PID set point (AI1)
- Process feedback (AI2)
- Start/stop selection (DI1)
- Internal setpoint selection 1 (DI2)
- Internal setpoint selection 2 (DI3)
- Constant speed selection 1 (DI4)

Output signals

- Digital output: Running
 - Relay output: Fault(-1)
 - Analog output AO: Output frequency
-

A large, bold, black number '5' is centered within a light gray square with rounded corners.

Program features

What this chapter contains

- *Local and external control locations*
 - *Operating modes of the drive*
 - *Drive configuration and programming*
 - *Control interfaces*
 - *Motor control*
 - *Application control*
 - *DC voltage control*
 - *Safety and protections*
 - *Diagnostics*
 - *Miscellaneous*
-

Local and external control locations

There are two main control locations: local and external. Depending on the user interface, select between the local and remote control as follows:

- Integrated control panel: Change the Loc/Rem setting. See *Options menu* (page 17).
- Assistant control panel: Use the Loc/Rem key.
- Drive Composer PC tool: Change the Loc/Rem setting.

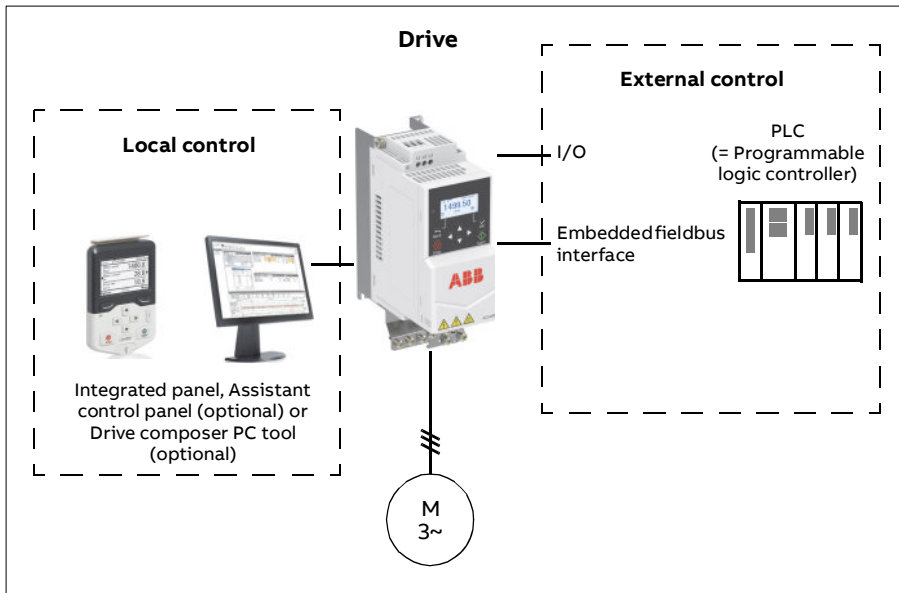

■ Local control

The control commands are given from the integrated/external control panel or from a PC equipped with Drive composer when the drive is in local control. Local control is mainly used during commissioning and maintenance. The control panel always overrides the external control signal sources when used in local control.

Changing the control location to local can be prevented by parameter 19.17.

You can use parameter 20.28 to select how the drive reacts when the control location is switched between local and external. Use parameter 49.05 to specify how the drive reacts to a control panel or PC tool communication break. (The parameter has no effect in external control.)

Settings and diagnostics

Parameters *19.16 Local control mode, 19.17 Local control disable, 20.28 Remote to local action* and *49.05 Communication loss action*.

Events: -

■ External control

When the drive is in external control, control commands are given through:

- the I/O terminals (digital and analog inputs)
- the fieldbus interface (via the embedded fieldbus interface)
- external panel (assistant/basic panel).

Two external control locations, EXT1 and EXT2, are available. You can select the sources of the start and stop commands separately for each location by setting parameters *20.01...20.10*. The operating mode can be selected separately for each location, which enables quick switching between different operating modes, for example speed and torque control. Selection between EXT1 and EXT2 is done via any binary source such as a digital input or fieldbus control word by a parameter *19.11*. You can also select the source of reference for each operating mode separately.

Events: -

Block diagram: Run enable source for EXT1

The figure below shows the parameters that select the interface for run enable for external control location *EXT1*.

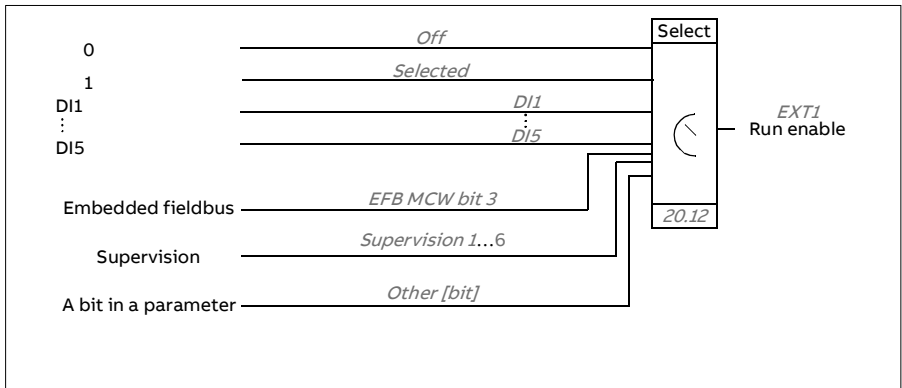

Settings and diagnostics

Parameters *19.11 Ext1/Ext2 selection* and *20.01...20.10*.

Events: -

Operating modes of the drive

The drive can operate in several operating modes with different types of reference. The operating mode is selectable for each control location (*Local*, *EXT1* and *EXT2*) when the motor control mode is *Vector* (99.04). If the motor control mode is *Scalar*, the drive operation mode is fixed to frequency control mode.

An overview of the control hierarchy and different reference types and control chains is shown below.

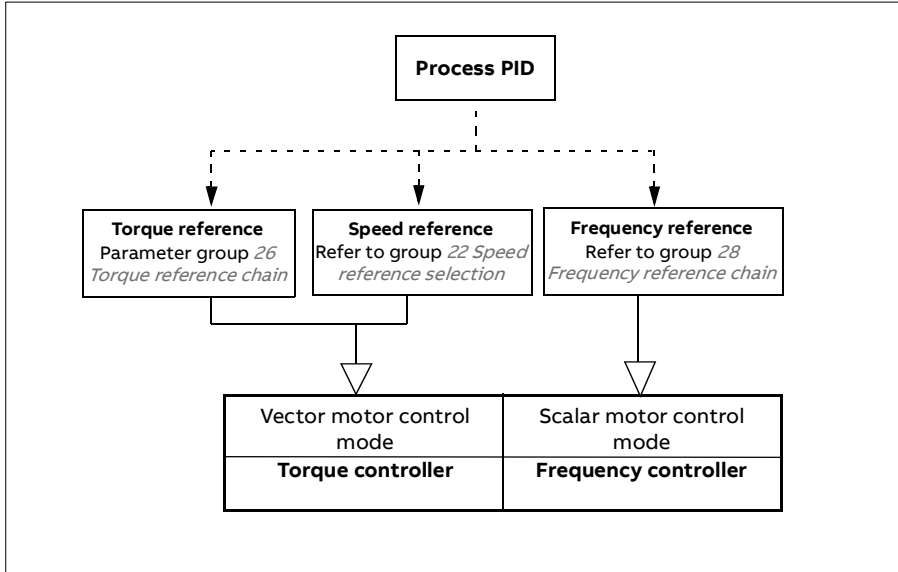

■ Speed control mode

In speed control mode, the motor follows a speed reference given to the drive.

Speed control mode is available in both local and external control locations. It is supported in vector motor control only.

Speed control uses speed reference chain.

Settings and diagnostics

Parameter group: *22 Speed reference selection*

Events: -

■ Torque control mode

In torque control mode, the motor torque follows a torque reference given to the drive. Torque control mode is available in both local and external control locations. It is supported in vector motor control only.

Torque control uses torque reference chain.

Settings and diagnostics

Parameter group: *26 Torque reference chain*

Events: -

■ Frequency control mode

In frequency control mode, the motor follows the drive output frequency reference. Frequency control is available in both local and external control location. It is supported in scalar motor control only.

Frequency control uses frequency reference chain.

Settings and diagnostics

Parameter group: *28 Frequency reference chain* (page 192)

Events: -

■ Special control modes

In addition to the above-mentioned operating modes, the following special operating modes are available:

- Process PID control. For more information, see section *Process PID control* on page 75.
 - Emergency stop modes OFF1 and OFF3: Drive stops along the defined deceleration ramp and drive modulation stops.
 - Jogging mode: Drive starts and accelerates to the defined speed when the jogging signal is activated. For more information, see section *Jogging* on page 63.
 - Pre-magnetization: DC magnetization of the motor before start. For more information, see section *Pre-magnetization* on page 71.
 - DC hold: Locking the rotor at (near) zero speed in the middle of normal operation. For more information, see section *DC hold* on page 71.
 - Pre-heating (motor heating): Keeping the motor warm when the drive is stopped. For more information, see section *Pre-heating (Motor heating)* on page 72.
-

■ Settings and diagnostics

Parameter groups: 06 Control and status words, 20 Start/stop/direction, 22 Speed reference selection, 23 Speed reference ramp and 40 Process PID set 1.

Events: -

Drive configuration and programming

The drive control program is divided into two parts:

- firmware program
- application program

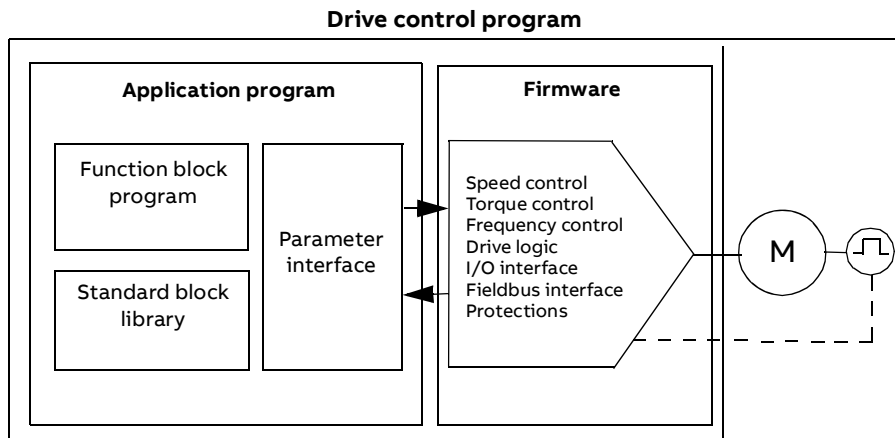

The firmware program performs the main control functions, including speed, torque and frequency control, drive logic (start/stop), I/O, feedback, communication and protection functions. Firmware functions are configured and programmed with parameters.

■ Programming via parameters

Parameters configure all of the standard drive operations and can be set via

- the integrated panel, as described in chapter *Control panel*
- an external panel
- the Drive composer PC tool, as described in *Drive composer PC tool user's manual* (3AUA0000094606 [English]), or
- the fieldbus interface, as described in chapters *Fieldbus control through the embedded fieldbus interface (EFB)*.

All parameter settings are stored automatically to the permanent memory of the drive, except the parameters which are modified by fieldbus.

If necessary, the default parameter values can be restored by parameter *96.06 Parameter restore*.

Settings and diagnostics

Parameters: *96.06 Parameter restore...96.07 Parameter save manually*.

Events: -

■ **Adaptive programming**

Conventionally, you can control the operation of the drive by parameters. However, the standard parameters have a fixed set of choices or a setting range. To further customize the operation of the drive, an adaptive program can be constructed out of a set of function blocks.

The Drive composer pro/entry PC tool (version 1.11 or later, available separately) has an Adaptive programming feature with a graphical user interface for building the custom program. The function blocks include the usual arithmetic and logical functions, as well as e.g., selection, comparison and timer blocks.

The physical inputs, drive status information, actual values, constants and parameters can be used as the input for the program. The output of the program can be used e.g., as a start signal, external event or reference, or connected to the drive outputs. See the table below for a listing of the available inputs and outputs.

If you connect the output of the adaptive program to a selection parameter that is a pointer parameter, the selection parameter will be write-protected.

Example:

If parameter *31.01 External event 1 source* is connected to an adaptive programming block output, the parameter value is shown as *Adaptive program* on a control panel or PC-tool. The parameter is write-protected (= the selection cannot be changed).

The status of the adaptive program is shown by parameter *07.30 Adaptive program status*. The adaptive program needs to be enabled for programming and program usage (see parameter *96.70 Disable adaptive program*).

For more information, see the *Adaptive programming application guide* (3AXD5000028574 [English]).

Inputs available to the adaptive program	
Input	Source
I/O	
DI1	10.02 DI delayed status, bit 0
DI2	10.02 DI delayed status, bit 1
DI3	10.02 DI delayed status, bit 2
DI4	10.02 DI delayed status, bit 3

Inputs available to the adaptive program	
<i>Input</i>	<i>Source</i>
DI5	10.02 DI delayed status, bit 4
AI1	12.11 AI1 actual value
AI2	12.21 AI2 actual value
<i>Actual signals</i>	
Motor speed	01.01 Motor speed used
Output frequency	01.06 Output frequency
Motor current	01.07 Motor current
Motor torque	01.10 Motor torque
Motor shaft power	01.17 Motor shaft power
<i>Status</i>	
Enabled	06.16 Drive status word 1, bit 0
Inhibited	06.16 Drive status word 1, bit 1
Ready to start	06.16 Drive status word 1, bit 3
Tripped	06.11 Main status word, bit 3
At setpoint	06.11 Main status word, bit 8
Limiting	06.16 Drive status word 1, bit 7
Ext1 active	06.16 Drive status word 1, bit 10
Ext2 active	06.16 Drive status word 1, bit 11
<i>Data storage</i>	
Data storage 1 real32	47.01 Data storage 1 real32
Data storage 2 real32	47.02 Data storage 2 real32
Data storage 3 real32	47.03 Data storage 3 real32
Data storage 4 real32	47.04 Data storage 4 real32

Outputs available to the adaptive program	
<i>Output</i>	<i>Target</i>
<i>I/O</i>	
RO1	10.21 RO status, bit0
AO1	13.12 AO1 source
DO1	11.06 DO1 output source
<i>Start control</i>	
Ext1/Ext2 selection	19.11 Ext1/Ext2 selection
Run enable 1	20.12 Run enable 1 source
Ext1 in1 cmd	20.03 Ext1 in1 source
Ext1 in2 cmd	20.04 Ext1 in2 source
Ext1 in3 cmd	20.05 Ext1 in3 source
Ext2 in1 cmd	20.08 Ext2 in1 source
Ext2 in2 cmd	20.09 Ext2 in2 source
Ext2 in3 cmd	20.10 Ext2 in3 source
Fault reset	31.11 Fault reset selection
<i>Speed control</i>	
Ext1 speed reference	22.11 Ext1 speed ref1
Speed proportional gain	25.02 Speed proportional gain
Speed integration time	25.03 Speed integration time

Outputs available to the adaptive program	
<i>Output</i>	<i>Target</i>
Acceleration time 1	23.12 Acceleration time 1
Deceleration time 1	23.13 Deceleration time 1
<i>Frequency control</i>	
Ext1 frequency reference	28.11 Ext1 frequency ref1
<i>Torque control</i>	
Ext1 torque reference	26.11 Torque ref1 source
Ext2 torque reference	26.12 Torque ref2 source
<i>Limit function</i>	
Minimum torque 2	30.21 Min torque 2 source
Maximum torque 2	30.22 Max torque 2 source
<i>Events</i>	
External event 1	31.01 External event 1 source
External event 2	31.03 External event 2 source
External event 3	31.05 External event 3 source
External event 4	31.07 External event 4 source
External event 5	31.09 External event 5 source
<i>Data Storage</i>	
Data storage 1 real32	47.01 Data storage 1 real32
Data storage 2 real32	47.02 Data storage 2 real32
Data storage 3 real32	47.03 Data storage 3 real32
Data storage 4 real32	47.04 Data storage 4 real32
<i>Process PID</i>	
Set 1 setpoint 1	40.16 Set 1 setpoint 1 source
Set 1 setpoint 2	40.17 Set 1 setpoint 2 source
Set 1 feedback 1	40.08 Set 1 feedback 1 source
Set 1 feedback 2	40.09 Set 1 feedback 2 source
Set 1 gain	40.32 Set 1 gain
Set 1 integration time	40.33 Set 1 integration time
Set 1 tracking mode	40.49 Set 1 tracking mode
Set 1 track reference	40.50 Set 1 tracking ref selection

Adaptive program fault and aux code formats

The format of the aux code:

Bits 24-31: State number	Bits 16-23: block number	Bits 0-15: error code
--------------------------	--------------------------	-----------------------

If the state number is zero but the block number has a value, the fault is related to a function block in the base program. If both state number and block number are zero, the fault is a generic fault that is not related to a specific block.

Sequence program

An adaptive program can contain base program and sequence program parts. Base program is run continuously when adaptive program is in running mode.

The functionality of the base program is programmed using function blocks and system inputs and outputs.

Sequence program is a state machine. This means that only one state of the sequence program is run at a time. You can create a sequence program by adding states and programming the state programs using the same program elements as in the base program. You can program state transitions by adding state transition outputs to the state programs. The state transition rules are programmed using function blocks.

The number of the active state of the sequence program is shown by parameter *07.31 AP sequence state*.

Control interfaces

■ Programmable analog inputs

There are two programmable analog inputs. Each of the inputs can be independently set as a voltage (0/2...10 V) or current (0/4...20 mA) input by parameter. Each input can be filtered, inverted and scaled. AI1 can be configured as DI5 by parameter.

Settings and diagnostics

Parameter group *12 Standard AI* and *11.21 DI5 configuration*.

Events: -

■ Programmable analog outputs

There is one analog output voltage (0/2...10 V) or current (0/4...20 mA) output (can be set by parameter). The output can be filtered, inverted and scaled.

Settings and diagnostics

Parameter group *13 Standard AO*.

Events: -

■ Programmable digital inputs and outputs

There are four digital inputs, and one digital outputs. In addition, the analog input AI1 can be configured as digital input DI5 by a parameter.

Digital inputs DI3 and DI4 can be used as frequency input.

Settings and diagnostics

Parameter groups *10 Standard DI, RO* and *11 Standard DIO, FI, FO*.

Events: -

■ Programmable relay outputs

There is one relay output. The signal indicated by the output can be selected by a parameter.

Settings and diagnostics

Parameter *10.22...10.24 RO1 source*.

Events: -

■ Fieldbus control

The drive can be connected to an automation systems through its fieldbus interface. See chapter *Fieldbus control through the embedded fieldbus interface (EFB)*.

Settings and diagnostics

Parameter group *58 Embedded fieldbus*.

Events: -

Motor control

■ Motor types

The drive supports the following motor types:

- Asynchronous AC induction motors
- Permanent magnet (PM) motors

Settings and diagnostics

Parameter *99.03 Motor type*.

Events: -

■ Motor identification

In scalar motor control mode (*99.04*), the drive performs no motor identification. The performance of vector control is based on an accurate motor model determined during the motor start-up.

A motor Identification magnetization is automatically performed the first time the start command is given. During this first start-up, the motor is magnetized at zero speed for several seconds to allow the motor model to be created. This identification method is suitable for most applications in vector control mode.

In demanding applications a separate Identification run (ID run) can be performed.

Settings and diagnostics

Parameter *99.13 ID run requested* (page 315).

Events: -

■ Scalar motor control

Scalar motor control is the default motor control method. It is suitable for applications which do not require the control accuracy available in vector control. In scalar control, you control the drive output frequency reference, and you do not need to do any motor identification at the first start.

ABB also recommends to activate scalar motor control mode in the following special situations:

- In multimotor drives: 1) if the load is not equally shared between the motors, 2) if the motors are of different sizes, or 3) if the motors are going to be changed after motor identification (ID run)
- If the nominal current of the motor is less than 1/6 of the nominal output current of the drive
Note: Do not activate the motor phase loss fault (*31.19 Motor phase loss*) as the drive cannot measure the motor current accurately.
- If the drive is used without a motor connected (for example, for test purposes)
- If the drive runs a medium-voltage motor through a step-up transformer.

In scalar control, some features are not available.

See also section *Operating modes of the drive* on page 48.

IR compensation for scalar motor control

IR compensation (also known as voltage boost) is available only when the motor control mode is scalar. When IR compensation is activated, the drive gives an extra voltage boost to the motor at low speeds. IR compensation is useful in applications that require a high break-away torque.

In vector control, no IR compensation is possible or needed as it is applied automatically.

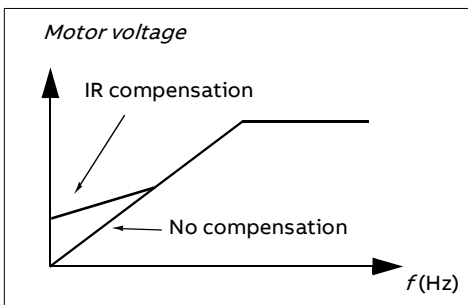

Settings and diagnostics

Parameter group *28 Frequency reference chain* (page 192). Parameters *97.13 IR compensation* (page 307) and *99.04 Motor control mode* (page 312).

Events: -

■ Vector control

Vector control is the motor control mode which is intended for applications where high control accuracy is needed. It offers better control over the whole speed range, in particular in applications where slow speed with high torque is needed. It requires a motor identification at startup. Vector control cannot be used in all applications, e.g. there are multiple motors connected to single drive.

The switching of the output semiconductors is controlled to achieve the required stator flux and motor torque.

Motor control requires measurement of the DC voltage and two motor phase currents. Stator flux is calculated by integrating the motor voltage in vector space. Motor torque is calculated as a cross product of the stator flux and the rotor current. By utilizing the identified motor model, the stator flux estimate is improved. Actual motor shaft speed is not needed for the motor control.

The best motor control accuracy is achieved by activating a separate motor identification run (ID run).

See also section *Speed control performance figures* on page 67.

Settings and diagnostics

Parameters *99.04 Motor control mode* (page 312) and *99.13 ID run requested* (page 315).

Events: -

■ Reference ramping

Acceleration and deceleration ramping times can be set individually for speed, torque and frequency reference.

With a speed or frequency reference, the ramps are defined as the time it takes for the drive to accelerate or decelerate between zero speed or frequency and the value defined by parameter (*46.01* or *46.02*). The user can switch between two preset ramp sets using a binary source such as a digital input. For speed reference, also the shape of the ramp can be controlled.

With a torque reference, the ramps are defined as the time it takes for the reference to change between zero and nominal motor torque (*01.30*).

Special acceleration/deceleration ramps

The acceleration/deceleration times for the jogging function can be defined separately; see section *Jogging* on page 63.

The change rate of the motor potentiometer function (page 104) is adjustable. The same rate applies in both directions.

A deceleration ramp can be defined for emergency stop ("Off3" mode).

Settings and diagnostics

- Speed reference ramping - Parameters *23.11...23.15, 23.32 Shape time 1, 23.33 Shape time 2* and *46.01 Speed scaling*.
- Torque reference ramping - Parameters *01.30 Nominal torque scale, 26.18 Torque ramp up time* and *26.19 Torque ramp down time*.
- Frequency reference ramping - Parameters *28.71...28.75* and *46.02 Frequency scaling*.
- Jogging - Parameters *23.20 Acc time jogging* and *23.21 Dec time jogging*.
- Motor potentiometer - Parameter *22.75 Motor potentiometer ramp time*.
- Emergency stop (“Off3” mode) - Parameter *23.23 Emergency stop time*.

Events: -

■ Constant speeds/frequencies

Constant speeds and frequencies are predefined references that can be quickly activated, for example, through digital inputs. It is possible to define up to 7 speeds for speed control and 7 constant frequencies for frequency control.



WARNING! Speeds and frequencies override the normal reference irrespective of where the reference is coming from.

Settings and diagnostics

Parameter groups *22 Speed reference selection* and *28 Frequency reference chain*.

Events: -

■ Critical speeds/frequencies

Critical speeds (sometimes called “skip speeds”) can be predefined for applications where it is necessary to avoid certain motor speeds or speed ranges because of, for example, mechanical resonance problems.

The critical speeds function prevents the reference from dwelling within a critical band for extended times. When a changing reference enters a critical range, the output of the function freezes until the reference exits the range. Any instant change in the output is smoothed out by the ramping function further in the reference chain.

When the drive is limiting the allowed output speeds/frequencies, it limits to the absolutely lowest critical speed (critical speed low or critical frequency low) when accelerating from standstill, unless the speed reference is over the upper critical speed/ frequency limit.

Example

A fan has vibrations in the range of 540 to 690 rpm and 1180 to 1560 rpm. To make the drive avoid these speed ranges,

- enable the critical speeds function by turning on bit 0 of parameter *22.51*, and
- set the critical speed ranges as in the figure below.

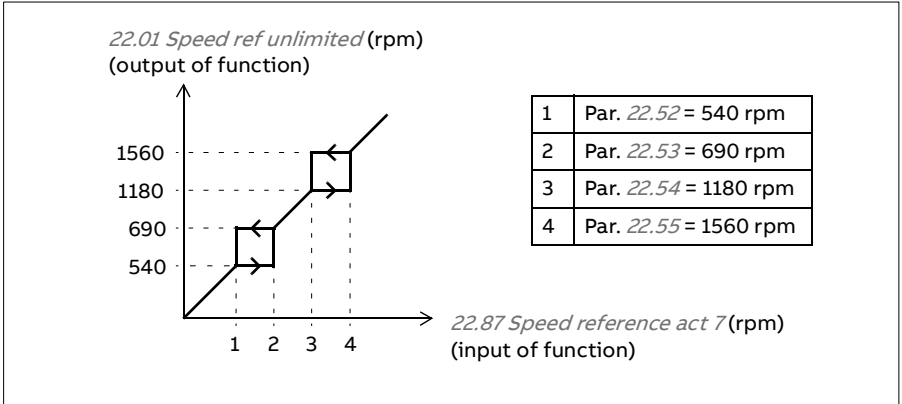

Settings and diagnostics

- Critical speeds - Parameters *22.51...22.57*.
- Critical frequencies - Parameters *28.51...28.57*.
- Function input (speed) - Parameter *22.01 Speed ref unlimited*.
- Function output (speed) - Parameter *22.87 Speed reference act 7*.
- Function input (frequency) - Parameter *28.96 Frequency ref act 7*.
- Function output (frequency) - Parameter *28.97 Frequency ref unlimited*.

Events: -

■ Speed controller autotune

The speed controller of the drive can be automatically adjusted using the autotune function. Autotuning is based on an estimation of the mechanical time constant (inertia) of the motor and machine.

The autotune routine will run the motor through a series of acceleration/deceleration cycles, the number of which can be adjusted by parameter *25.40*. Higher values will produce more accurate results, especially if the difference between initial and maximum speeds is small.

The maximum torque reference used during autotuning will be the initial torque (that is, torque when the routine is activated) plus *25.40*, unless limited by the maximum torque limit (parameter group *30 Limits*) or the nominal motor

torque (*99 Motor data*). The calculated maximum speed during the routine is the initial speed (that is, speed when the routine is activated) + *25.39*, unless limited by parameter *30.12* or *99.09*.

The diagram below shows the behavior of speed and torque during the autotune routine. In this example, *25.40* is set to 2.

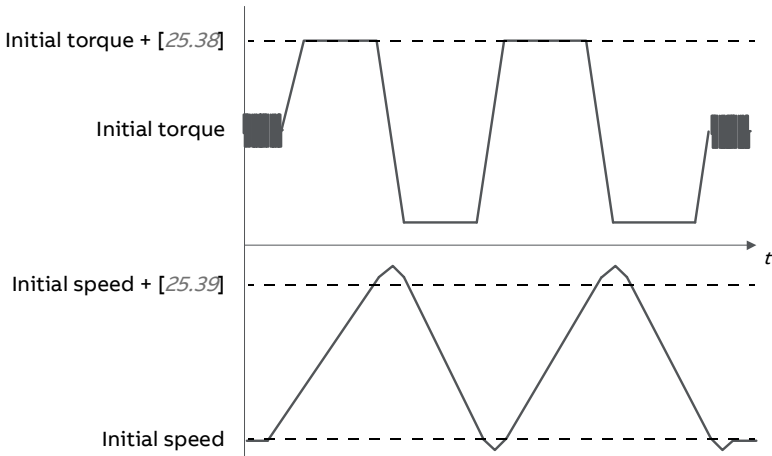

Notes:

- If the drive cannot produce the requested braking power during the routine, the results will be based on the acceleration stages only, and not as accurate as with full braking power.
- The motor will exceed the calculated maximum speed slightly at the end of each acceleration stage.

Before activating the autotune routine

The prerequisites for performing the autotune routine are:

- The motor identification run (ID run) has been successfully completed
- Speed and torque limits (parameter group *30 Limits*) have been set
- The drive has been started and is running in speed control mode.

After these conditions have been fulfilled, autotuning can be activated by parameter *25.33* (or the signal source selected by it).

Note: Speed controller autotuning works only, when the speed stays within a specific window during the sequence:

- Speed is max 90% of the motor nominal speed or max speed (group 30 limits), which ever is smaller.
- Speed is min 10% of the motor nominal speed or minimum speed (group 30 limits), which ever is bigger.

Autotune modes

Autotuning can be performed in three different ways depending on the setting of parameter 25.34. The selections *Smooth*, *Normal* and *Tight* define how the drive torque reference should react to a speed reference step after tuning. The selection *Smooth* will produce a slow but robust response; *Tight* will produce a fast response but possibly too high gain values for some applications. The figure below shows speed responses at a speed reference step (typically 1...20%).

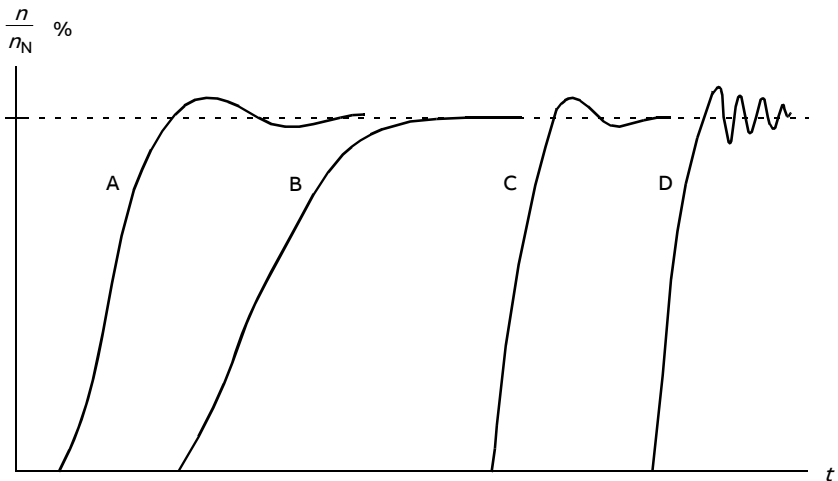

- A: Undercompensated
 B: Normally tuned (autotuning)
 C: Normally tuned (manually). Better dynamic performance than with B
 D: Overcompensated speed controller

Autotune results

At the end of a successful autotune routine, its results are automatically transferred into parameters

- 25.02 (proportional gain of the speed controller)
- 25.03 (integration time of the speed controller)
- 25.06 (derivation time of acceleration(/deceleration) compensation)
- 25.37 (mechanical time constant of the motor and machine).

Nevertheless, it is still possible to manually adjust the controller gain, integration time and derivation time.

The figure below is a simplified block diagram of the speed controller. The controller output is the reference for the torque controller.

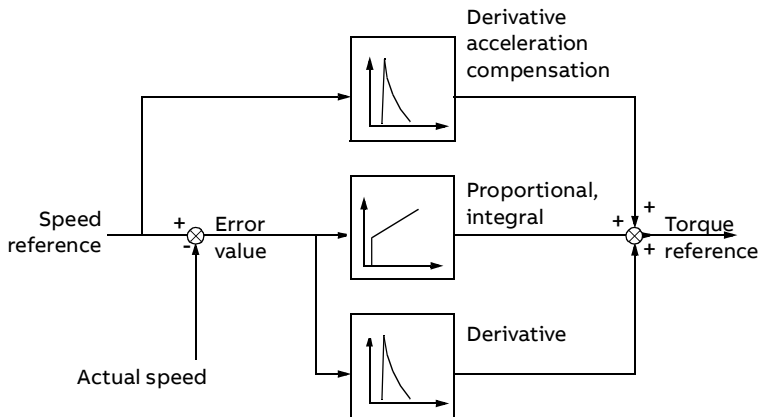

Warning indications

A warning message *AF90*, will be generated if the autotune routine does not complete successfully. See chapter *Fault tracing* (page 353) for further information.

Settings and diagnostics

Parameters groups: 25 *Speed control* (page 182), 30 *Limits* (page 204) and 99 *Motor data* (page 311).

Parameters: 25.02 *Speed proportional gain* (page 182), 25.03 *Speed integration time* (page 183), 25.33 *Speed controller autotune...* 25.40 *Autotune repeat times* (page 186), 30.12 *Maximum speed* (page 206) and 99.09 *Motor nominal speed* (page 313).

Events: *AF90 Autotune* (page 364).

■ Rush control

Rush control is automatically on when the operation mode is torque. In torque control, the motor could potentially rush if the load were suddenly lost. The control program has a rush control function that decreases the torque reference whenever the motor speed exceeds the set minimum speed or maximum speed.

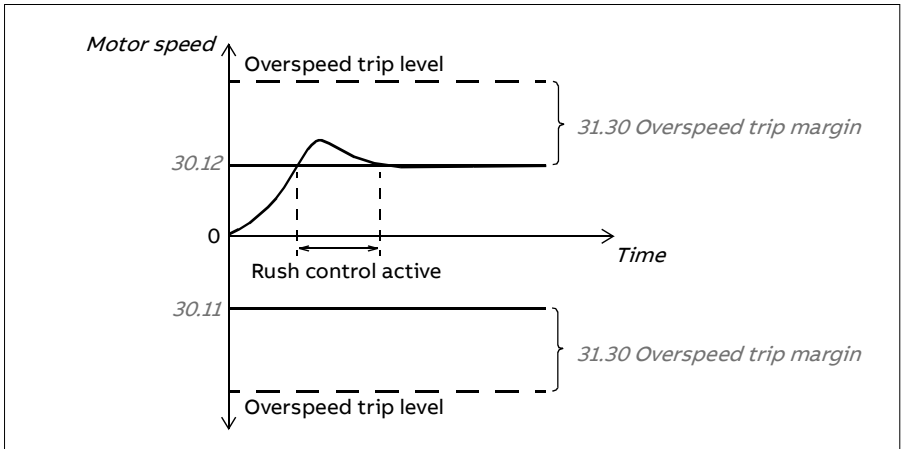

The function is based on a PI controller. The program sets the proportional gain to 5.0 and integration time to 2.5 s.

Settings and diagnostics

Parameters *30.11 Minimum speed* (page 206), *30.12 Maximum speed* (page 206) and *31.30 Overspeed trip margin* (page 218).

Events: -

■ Jogging

The jogging function enables the use of a momentary switch to briefly rotate the motor. The jogging function is typically used during servicing or commissioning to control the machinery locally.

Two jogging functions (1 and 2) are available, each with their own activation sources and references. The signal sources are selected by parameters *20.26* and *20.27*. When jogging is activated, the drive starts and accelerates to the defined jogging speed along the defined jogging acceleration ramp. After the activation signal switches off, the drive decelerates to a stop along the defined jogging deceleration ramp.

The figure and table below provide an example of how the drive operates during jogging. In the example, the ramp stop mode is used (*21.03 Stop mode*).

Jog cmd = State of source set by 20.26 or 20.27

Jog enable = State of source set by 20.25

Start cmd = State of drive start command.

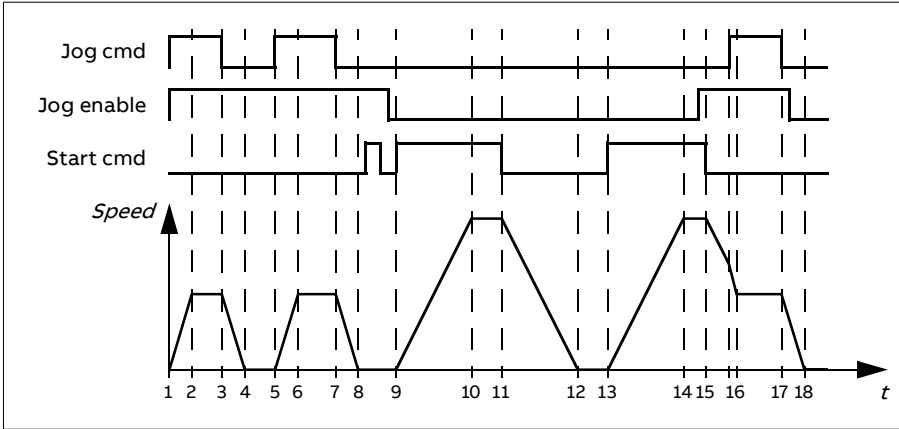

Phase	Jog cmd	Jog enable	Start cmd	Description
1-2	1	1	0	Drive accelerates to the jogging speed along the acceleration ramp of the jogging function.
2-3	1	1	0	Drive follows the jog reference.
3-4	0	1	0	Drive decelerates to zero speed along the deceleration ramp of the jogging function.
4-5	0	1	0	Drive is stopped.
5-6	1	1	0	Drive accelerates to the jogging speed along the acceleration ramp of the jogging function.
6-7	1	1	0	Drive follows the jog reference.
7-8	0	1	0	Drive decelerates to zero speed along the deceleration ramp of the jogging function.
8-9	0	1->0	0	Drive is stopped. As long as the jog enable signal is on, start commands are ignored. After jog enable switches off, a fresh start command is required.
9-10	x	0	1	Drive accelerates to the speed reference along the selected acceleration ramp (parameters 23.11...23.15).
10-11	x	0	1	Drive follows the speed reference.
11-12	x	0	0	Drive decelerates to zero speed along the selected deceleration ramp (parameters 23.11...23.15).
12-13	x	0	0	Drive is stopped.
13-14	x	0	1	Drive accelerates to the speed reference along the selected acceleration ramp (parameters 23.11...23.15).

Phase	Jog cmd	Jog enable	Start cmd	Description
14-15	x	0->1	1	Drive follows the speed reference. As long as the start command is on, the jog enable signal is ignored. If the jog enable signal is on when the start command switches off, jogging is enabled immediately.
15-16	0->1	1	0	Start command switches off. The drive starts to decelerate along the selected deceleration ramp (parameters 23.11...23.15). When the jog command switches on, the decelerating drive adopts the deceleration ramp of the jogging function.
16-17	1	1	0	Drive follows the jog reference.
17-18	0	1->0	0	Drive decelerates to zero speed along the deceleration ramp of the jogging function.

Notes:

- Jogging is not available when the drive is in local control.
- Jogging cannot be enabled when the drive start command is on, or the drive started when jogging is enabled. Starting the drive after the jog enable switches off requires a fresh start command.



WARNING! If jogging is enabled and activated while the start command is on, jogging will activate as soon as the start command switches off.

- If both jogging functions are activated, the one that was activated first has priority.
- Jogging function can only be used in Speed control mode.
- The inching functions activated through fieldbus (06.01 bits 8...9) use the references and ramp times defined for jogging, but do not require the jog enable signal.

Settings and diagnostics

Parameters 20.25 Jogging enable (page 155), 20.26 Jogging 1 start source (page 156), 20.27 Jogging 2 start source (page 156), 22.42 Jogging 1 ref (page 173), 22.43 Jogging 2 ref (page 173), 23.20 Acc time jogging (page 178), 23.21 Dec time jogging (page 178), 28.42 Jogging 1 frequency ref (page 199), and 28.43 Jogging 2 frequency ref (page 199).

Events: -

■ Autophasing

Autophasing is an automatic measurement routine to determine the angular position of the magnetic flux of a permanent magnet synchronous motor. The motor control requires the absolute position of the rotor flux in order to control motor torque accurately.

The autophasing routine is performed at every start.

Note: The motor may turn when it is started as the shaft is turned towards the remanence flux.

Bit 4 of *06.21 Drive status word 3* indicates if the rotor position has already been determined.

Autophasing modes

Several autophasing modes are available in the drive (see parameter *21.13 Autophasing mode*).

The turning mode (*Turning*) is the most robust and accurate method. In turning mode, the motor shaft is turned back and forward ($\pm 360/\text{polepairs}$)° in order to determine the rotor position. In turning 2 mode (*Turning 2*), the shaft is turned only in one direction and the angle is smaller.

The drive is capable of determining the rotor position when started into a running motor. In this situation, the setting of *21.13 Autophasing mode* has no effect.

An autophasing fault (*3385 Autophasing*) could be caused by, for example, the following:

- The motor is already turning before the autophasing routine is started
- The motor shaft is locked
- *Turning* mode is selected in *21.13 Autophasing mode* but the motor shaft is locked
- The wrong motor type is selected in *99.03 Motor type*
- Motor ID run has failed.

Settings and diagnostics

Parameters *06.21 Drive status word 3* and *99.13 ID run requested*.

Events: -

■ Speed control performance figures

The table below shows typical performance figures for speed control.

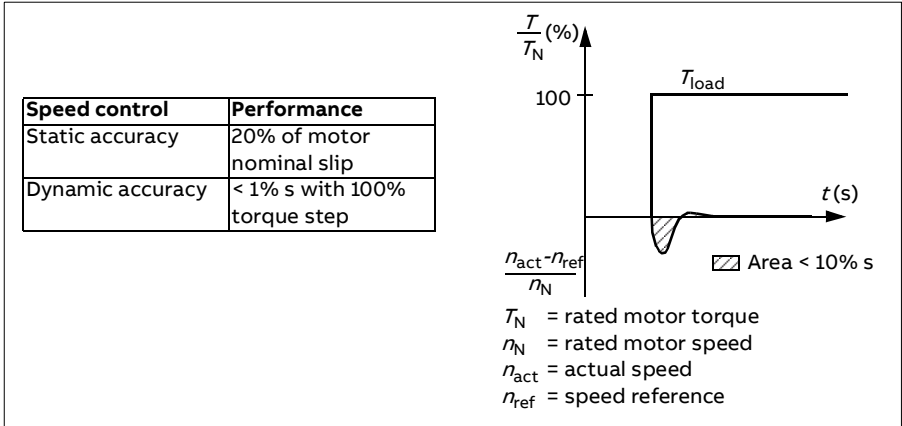

■ Torque control performance figures

The drive can perform precise torque control without any speed feedback from the motor shaft. The table below shows typical performance figures for torque control.

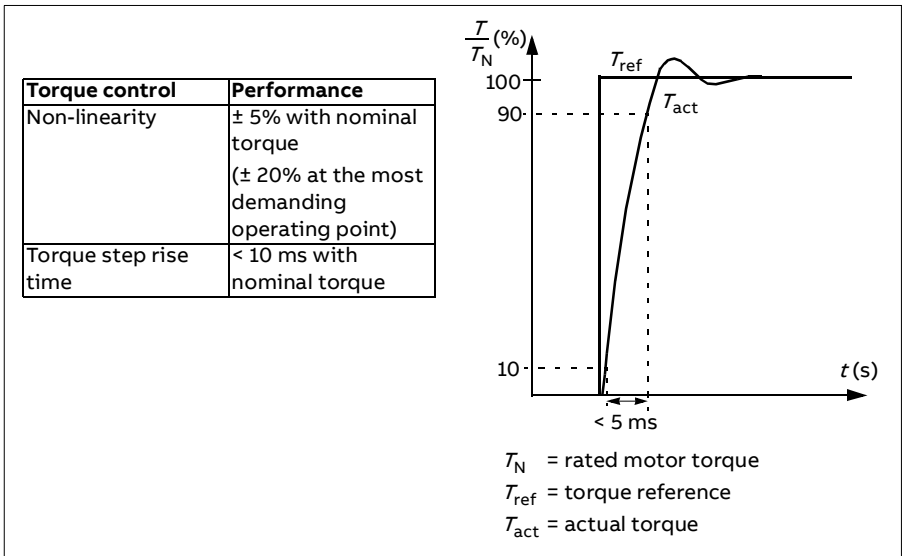

■ User load curve

The User load curve provides a supervisory function that monitors an input signal as a function of frequency or speed, and load. It shows the status of the monitored signal and can give a warning or fault based on the violation of a user defined profile.

The user load curve consists of an overload and an underload curve, or just one of them. Each curve is formed by five points that represent the monitored signal as a function of frequency or speed.

In the example below, the user load curve is constructed from the motor nominal torque to which a 10% margin is added and subtracted. The margin curves define a working envelope for the motor so that excursions outside the envelope can be supervised, timed and detected.

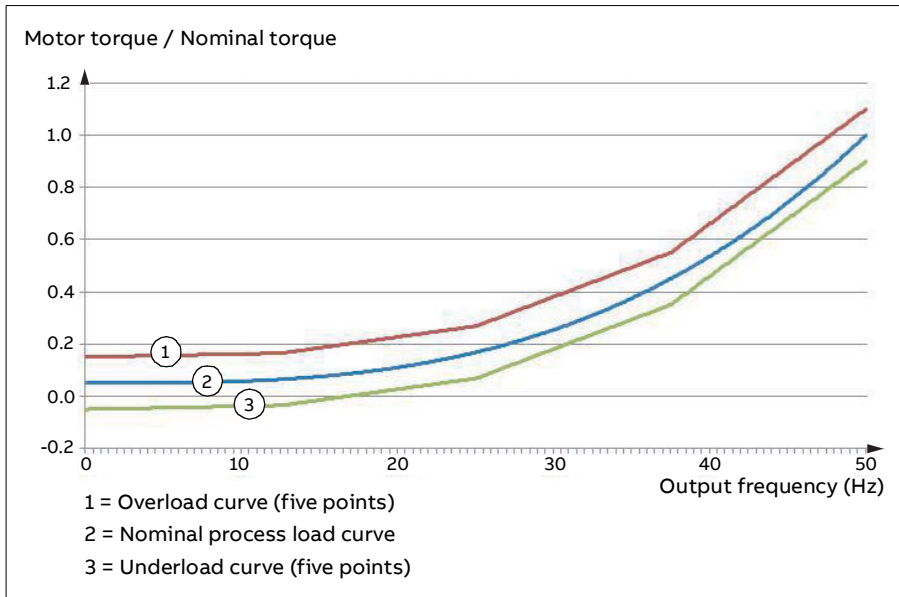

An overload warning and/or fault can be set to occur if the monitored signal stays continuously over the overload curve for a defined time. An underload warning and/or fault can be set to occur if the monitored signal stays continuously under the underload for a defined time.

Overload can be for example used to monitor for a saw blade hitting a knot or fan load profiles becoming too high.

Underload can be for example used to monitor for load dropping and breaking of conveyer belts or fan belts.

Settings and diagnostics

Parameter group *37 User load curve*.

Events: A8BE ULC overload warning, A8BF ULC underload warning, 8001 ULC underload fault, 8002 ULC overload fault

■ *U/f* ratio

The *U/f* function is only available in scalar motor control mode, which uses frequency control.

The function has two modes: linear and squared.

In linear mode, the ratio of voltage to frequency is constant below the field weakening point. This is used in constant torque applications where it may be necessary to produce torque at or near the rated torque of the motor throughout the frequency range

In squared mode, the ratio of the voltage to frequency increases as the square of the frequency below the field weakening point. This is typically used in centrifugal pump or fan applications. For these applications, the torque required follows the square relationship with frequency. Therefore, if the voltage is varied using the square relationship, the motor operates at improved efficiency and lower noise levels in these applications.

The *U/f* function cannot be used with energy optimization; if parameter *45.11 Energy optimizer* is set to *Enable*, parameter *97.20 U/f ratio* is ignored.

Settings and diagnostics

Parameter *97.20 U/f ratio* (page 308).

Events: -

■ Flux braking

The drive can provide greater deceleration by raising the level of magnetization in the motor. By increasing the motor flux, the energy generated by the motor during braking can be converted to motor thermal energy.

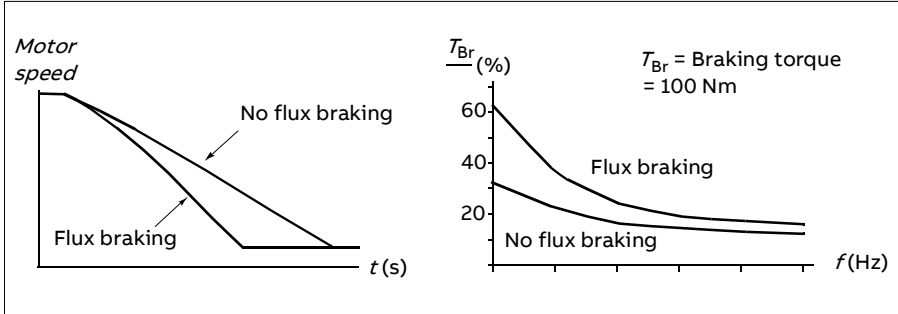

The drive monitors the motor status continuously, also during flux braking. Therefore, flux braking can be used both for stopping the motor and for changing the speed. The other benefits of flux braking are:

- The braking starts immediately after a stop command is given. The function does not need to wait for the flux reduction before it can start the braking.
- The cooling of the induction motor is efficient. The stator current of the motor increases during flux braking, not the rotor current. The stator cools much more efficiently than the rotor.
- Flux braking can be used with induction motors and permanent magnet motors.

Two braking power levels are available:

- Moderate braking provides faster deceleration compared to a situation where flux braking is disabled. The flux level of the motor is limited to prevent excessive heating of the motor.
- Full braking exploits almost all available current to convert the mechanical braking energy to motor thermal energy. Braking time is shorter compared to moderate braking. In cyclic use, motor heating may be significant.



WARNING! The motor needs to be rated to absorb the thermal energy generated by flux braking.

Settings and diagnostics

Parameter *97.05 Flux braking* (page 305).

Events: -

■ DC magnetization

The drive has different magnetization functions for different phases of motor start/rotation/stop: pre-magnetization, DC hold, post-magnetization and pre-heating (motor heating).

Pre-magnetization

Pre-magnetization refers to DC magnetization of the motor before start. Depending on the selected start mode (vector or scalar) pre-magnetization can be applied to guarantee the highest possible breakaway torque, up to 200% of the nominal torque of the motor. By adjusting the pre-magnetization time, it is possible to synchronize the motor start and, for example, the release of a mechanical brake.

Settings and diagnostics

Parameters *21.01 Start mode* (page 157), *21.19 Scalar start mode* (page 163) and *21.02 Magnetization time* (page 158).

Events: -

DC hold

The function makes it possible to lock the rotor at (near) zero speed in the middle of normal operation. DC hold is activated by parameter *21.08*. When both the reference and motor speed drop below a certain level, the drive will stop generating sinusoidal current and start to inject DC into the motor. The current is set by parameter *21.10*. When the reference exceeds parameter *21.09*, normal drive operation continues.

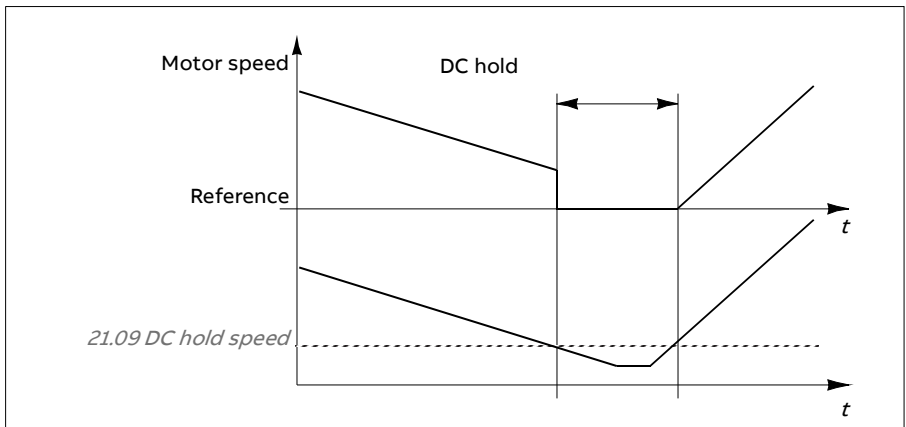

Settings and diagnostics

Parameters *21.08 DC current control* (page 162), *21.09 DC hold speed* (page 162) and *21.10 DC current reference* (page 162).

Events: -

Post-magnetization

The function keeps the motor magnetized for a certain period after stopping. This is to prevent the machinery from moving under load, for example before a mechanical brake can be applied. Post-magnetization is activated by parameter *21.08*. The magnetization current is set by parameter *21.10*.

Note: Post-magnetization is only available when ramping is the selected stop mode.

Settings and diagnostics

Parameters *21.01 Start mode* (page 157), *21.02 Magnetization time* (page 158), *21.03 Stop mode* (page 159), *21.08 DC current control* (page 162), *21.09 DC hold speed* (page 162) and *21.11 Post magnetization time* (page 162).

Events: -

Pre-heating (Motor heating)

The pre-heating function keeps the motor warm and prevents condensation inside the motor by feeding it with DC current when the drive has been stopped. The heating can only be activated when the drive is in the stopped state, and starting the drive stops the heating.

When pre-heating is activated and the stop command is given, pre-heating starts immediately if the drive is running below the zero speed limit (see bit 0 in parameter *06.19 Speed control status word*). If the drive is running above the zero speed limit, pre-heating is delayed by the time defined by parameter *21.15 Pre-heating time delay* to prevent excessive current.

The function can be defined to be always active when the drive is stopped or it can be activated by a digital input, fieldbus or supervision function. For example, with the help of signal supervision function, the heating can be activated by a thermal measurement signal from the motor.

The pre-heating current fed to the motor can be defined as 0...30% of the nominal motor current.

Notes:

- In applications where the motor keeps rotating for a long time after the modulation is stopped, it is recommended to use ramp stop with pre-heating to prevent a sudden pull at the rotor when the pre-heating is activated.
-

- The heating function requires that STO is not triggered.
- The heating function requires that the drive is not faulted.
- Pre-heating uses DC hold to produce current.

Settings and diagnostics

Parameters *21.14 Pre-heating input source* (page 163), *21.15 Pre-heating time delay* and *21.16 Pre-heating current* (page 163).

Events: -

■ Energy optimization

The Energy optimization function optimizes the motor flux so that total energy consumption and motor noise level are reduced when the drive operates below the nominal load. The total efficiency (motor and drive) can be improved by 1...20% depending on load torque and speed.

Note: With a permanent magnet motor, energy optimization is always enabled.

Settings and diagnostics

Parameter *45.11 Energy optimizer* (page 271).

Events: -

■ Switching frequency

The drive has two switching frequencies: reference switching frequency and minimum switching frequency. The drive tries to keep the highest allowed switching frequency (= reference switching frequency) if thermally possible, and then adjusts dynamically between the reference and minimum switching frequencies depending on the drive temperature. When the drive reaches the minimum switching frequency (= lowest allowed switching frequency), it starts to limit output current as the heating up continues.

For derating, see the hardware manual of the drive.

Example 1: If you need to fix the switching frequency to a certain value as with some external filters, e.g. with EMC C1 filters (see the hardware manual), set both the reference and the minimum switching frequency to this value and the drive will retain this switching frequency.

Example 2: If the reference switching frequency is set to 12 kHz and the minimum switching frequency is set to 1.5 kHz (or 1 kHz), the drive maintains the highest possible switching frequency to reduce motor noise and only when the drive heats it will decrease the switching frequency. This is useful, for example, in applications where low noise is necessary but higher noise can be tolerated when the full output current is needed.

Settings and diagnostics

Parameters *97.01 Switching frequency reference* (page 304) and *97.02 Minimum switching frequency* (page 304).

Events: -

■ Speed compensated stop

Speed compensation stop is available for example for applications where a conveyer needs to travel a certain distance after receiving the stop command. At maximum speed, the motor is stopped normally along the defined deceleration ramp, after the application of a user defined delay to adjust the distance traveled. Below maximum speed, stop is delayed still more by running the drive at current speed before the motor is ramped to a stop. As shown in the figure, the distance traveled after the stop command is the same in both cases, that is, area A + area B equals area C.

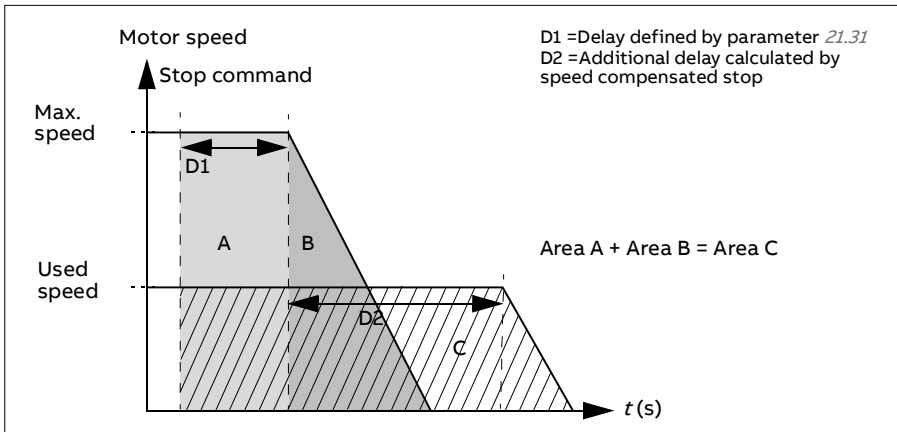

Speed compensation does not take into account shape times (parameters *23.32 Shape time 1* and *23.33 Shape time 2*). Positive shape times lengthen the distance traveled.

Speed compensation can be restricted to forward or reverse rotating direction. Speed compensation is supported in both vector and scalar motor control.

Settings and diagnostics

Parameters *21.30 Speed compensated stop mode* (page 166), *21.31 Speed comp stop delay* (page 166) and *21.32 Speed comp stop threshold* (page 166).

Events: -

Application control

■ Control macros

Control macros are predefined parameter edits and I/O configurations. See chapter *Control macros*.

■ Process PID control

There is a built-in process PID controller in the drive. The controller can be used to control process such as pressure or flow in the pipe or fluid level in the container.

In process PID control, a process reference (setpoint) is connected to the drive instead of a speed reference. An actual value (process feedback) is also brought back to the drive. The process PID control adjusts the drive speed in order to keep the measured process quantity (actual value) at the desired level (setpoint). This means that user does not need to set a frequency/speed/torque reference to the drive but the drive adjust its operation according to the process PID.

The simplified block diagram below illustrates the process PID control.

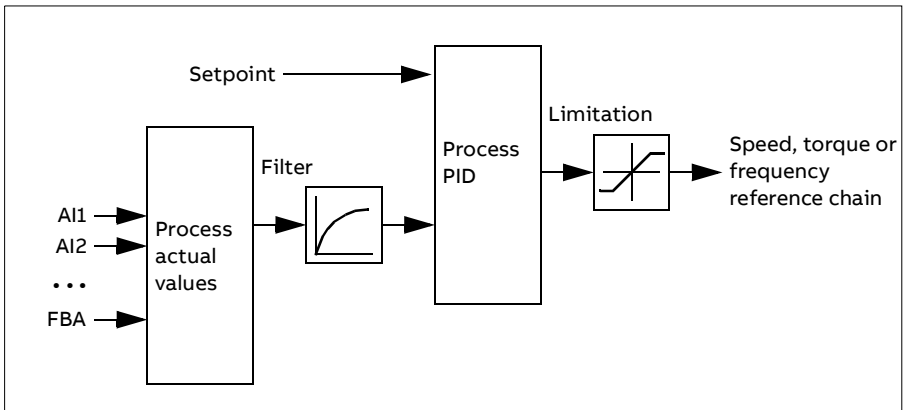

The drive contains two complete sets of process PID controller settings that can be alternated whenever necessary; see parameter *40.57 PID set1/set2 selection*.

Note: Process PID control is only available in external control; see section *Local and external control locations* on page 46.

Sleep and boost functions for process PID control

The sleep function is suitable for PID control applications where the consumption varies, such as clean water pumping systems. When used, it stops the pump completely during low demand, instead of running the pump slowly

below its efficient operating range. The following example visualizes the operation of the function.

Example: The drive controls a pressure boost pump. The water consumption falls at night. As a consequence, the process PID controller decreases the motor speed. However, due to natural losses in the pipes and the low efficiency of the centrifugal pump at low speeds, the motor would never stop rotating. The sleep function detects the slow rotation and stops the unnecessary pumping after the sleep delay has passed. The drive shifts into sleep mode, still monitoring the pressure. The pumping resumes when the pressure falls under the predefined minimum level and the wake-up delay has passed.

The user can extend the PID sleep time by the boost functionality. The boost functionality increases the process setpoint for a predetermined time before the drive enters the sleep mode.

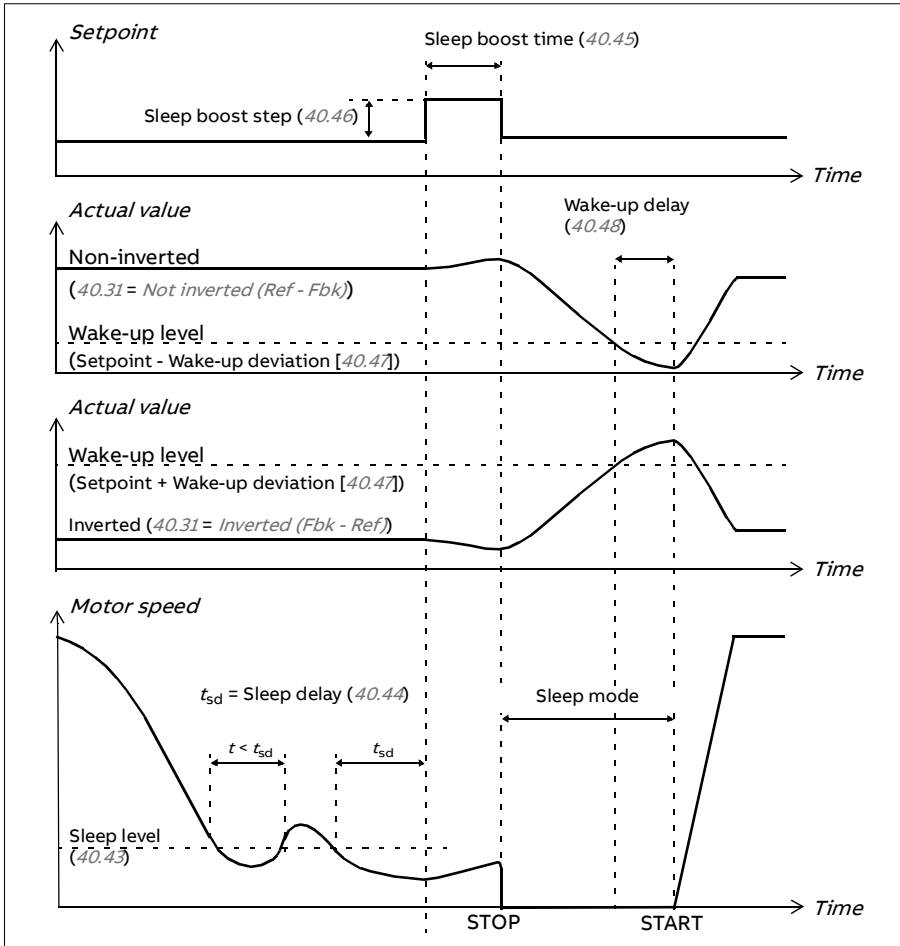

Tracking

In tracking mode, the PID block output is set directly to the value of parameter *40.50* (or *41.50*). The internal I term of the PID controller is set so that no transient is allowed to pass on to the output, so when the tracking mode is left, normal process control operation can be resumed without a significant bump.

Settings and diagnostics

Parameter *96.04 Macro select* (page 296).

Parameter groups *40 Process PID set 1* (page 248) and *41 Process PID set 2* (page 263).

Events: -

■ PID trim function

The PID trim function is used to maintain the set tension either by trimming the drive main speed reference or torque reference (speed controller output).



WARNING! Make sure that the drive acceleration and deceleration time is set to 0 when using the PID trim function. This is required to do quick tension control by speed correction.

PID trim is implemented as one of the Process PID functions (parameter groups *40 Process PID set 1* and *41 Process PID set 2*). Both PID set 1 and PID set 2 can be used for this functionality.

The trimmed output is calculated from parameter *40.01 Process PID output actual* or *40.03 Process PID setpoint actual*. In most cases *40.01 Process PID output actual* is used. This is based on the selection in parameter *40.56 Set 1 trim source* (for process PID set 1) or *41.56 Set 2 trim source* (for process PID set 2). In most of the use cases, the value of parameter *40.56* or *41.56* is set as *PID output*.

PID trim functionality in Variable Frequency Drives (VFD) is used in applications where tension control of the material is essential. For example, auxiliary drives in metal process industries, infeed and outfeed of rotogravure printing machines, and surface winders.

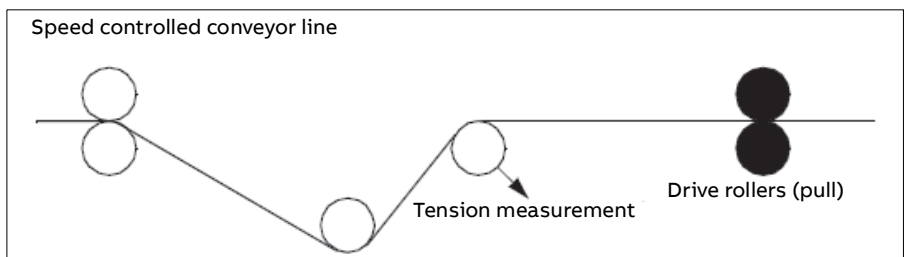

The examples provided in this chapter are based on PID set 1. You can set the desired values for the PID trim function parameters to get the expected result.

When PID trim is activated, bit 5 Trim mode is set to 1 in parameter *40.06 Process PID status word*.

See the speed, torque and frequency reference chains in chapter *10 Control chain diagrams* for more information on the PID trim addition to the respective reference chains.

The following PID trim modes are available:

- *Direct*
- *Proportional*
- *Combined*

Direct

The direct method is suitable when you need tension control at fixed rpm/line speed.

In this mode, the PID trim output (parameter *40.05 Process PID trim output act*) is relative to the maximum speed (parameter *30.12 Maximum speed*), torque (*30.20 Maximum torque 1*) or frequency (*30.14 Maximum frequency*). You can make the selection with parameter *40.52 Set 1 trim selection*.

The calculated trimmed output actual is the same throughout the speed range with respect to the stable PID output.

The *40.05 Process PID trim output act* value is calculated using the following formula:

$$\text{Par40.05} = \left(\frac{\text{Par40.01}}{100} \right) \times (\text{Par30.12 or 30.20 or 30.14}) \times \text{Par40.55}$$

The graph below shows the PID trim output in direct mode throughout the speed range. A fixed trim speed reference is added throughout the speed range.

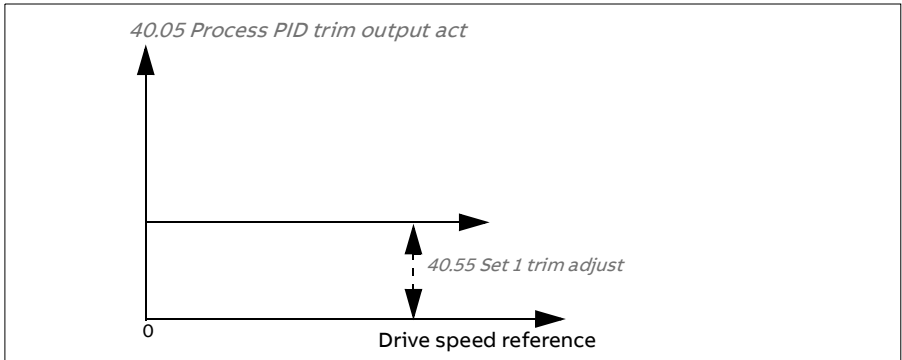

Note: In the above graph, it is assumed that the PID output is limited or stable at 100. This is for clarity only. In real life scenarios, the PID output can vary based on the setpoint and the actual value.

Example:

If:

parameter *40.52 Set 1 trim selection* = Speed

parameter *40.56 Set 1 trim source* = PID output

parameter *30.12 Maximum speed* = 1500 rpm

parameter *40.01 Process PID output actual* = 100 (limited to 100)

parameter *40.55 Set 1 trim adjust* = 0.5,

then:

$$\text{Par40.05} = \left(\frac{100}{100}\right) \times 1500 \times 0.5$$

$$\text{Par40.05} = 750$$

Proportional

The proportional method is suitable for applications where tension control is required throughout the speed range but not near zero speed.

In this mode, the PID trim output actual (parameter *40.05 Process PID trim output act*) is relative to the reference selected by parameter *40.53 Set 1 trimmed ref pointer* and with *40.01 Process PID output actual* or *40.03 Process PID setpoint actual*.

It is recommended that the speed reference selected in *40.53 Set 1 trimmed ref pointer* and the reference source in *22.11 Ext1 speed reflare* equal. This is required to make the proportional mode active.

In most of the use cases, the process speed reference is connected in *40.53 Set 1 trimmed ref pointer*. For example, if EXT1 control mode is used and the

reference source is AI scaled, then *22.11 Ext1 speed ref1* and *40.53 Set 1 trimmed ref pointer* should be configured to *AI1 scaled*.

Parameter *40.05 Process PID trim output act* is calculated using the following formula:

$$\text{Par40.05} = \left(\frac{\text{Par40.01}}{100} \right) \times \text{Par40.53} \times \text{Par40.55}$$

The below graph shows the PID trim output in proportional mode throughout the speed range. Here, the trimmed output is directly proportional to the value of parameter *40.53 Set 1 trimmed ref pointer*.

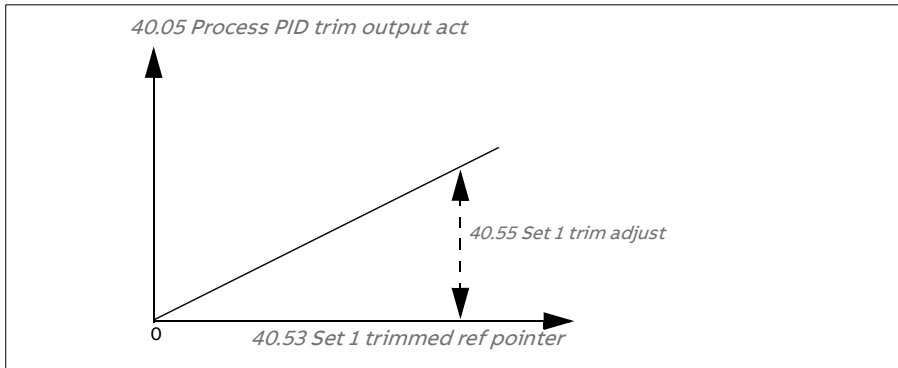

Note: In the above graph, it is assumed that the PID output is limited or stable at 100. This is for understanding purpose only. In real case scenario, PID output can vary based on the setpoint and actual.

Example:

If:

- parameter *40.52 Set 1 trim selection* = Speed
- parameter *40.56 Set 1 trim source* = PID output
- parameter *40.53 Set 1 trimmed ref pointer* = AI1 scaled
- parameter *22.11 Ext1 speed ref1* = AI1 scaled
- parameter *12.20 AI1 scaled at AI1 max* = 1500
- parameter *12.12 AI1 scaled value* = 750 (AI1 actual scaled value)
- parameter *40.01 Process PID output actual* = 100 (limited to 100)
- parameter *40.55 Set 1 trim adjust* = 0.5,

then:

$$\text{Par40.05} = \left(\frac{100}{100} \right) \times 750 \times 0.5$$

$$\text{Par40.05} = 375$$

At zero speed, the *40.05 Process PID trim output act* value depends on both the *40.55 Set 1 trim adjust* and *40.54 Set 1 trim mix* parameter values. However, adjusting *40.54 Set 1 trim mix* near to zero speed will give quick correction.

Example:

If,

parameter *40.52 Set 1 trim selection* = *Speed*

parameter *40.56 Set 1 trim source* = *PID output*

parameter *30.12 Maximum speed* = *1500 rpm*

parameter *40.53 Set 1 trimmed ref pointer* = *AI1 scaled*

parameter *22.11 Ext1 speed ref1* = *AI1 scaled*

parameter *12.20 AI1 scaled at AI1 max* = *1500*

parameter *12.12 AI1 scaled value* = *750* (AI1 actual scaled value)

parameter *40.01 Process PID output actual* = *100* (limited to 100)

parameter *40.54 Set 1 trim mix* = *0.1*

parameter *40.55 Set 1 trim adjust* = *0.5*

then

$$\text{Par40.05} = \left(\frac{100}{100} \right) \times 750 \times 0.5$$

$$\text{Par40.05} = 375$$

Combined

The combined mode is suitable for applications where the user needs to maintain tension from zero speed to maximum speed. The combined mode is a combination of direct and proportional modes. Here, the trim for zero speed is defined by parameter *40.54 Set 1 trim mix* and the trim for speed greater than zero speed is defined by parameter *40.55 Set 1 trim adjust*. The trim value is directly proportional to the value of parameter *40.53 Set 1 trimmed ref pointer*.

The process speed reference is connected in parameter *40.53 Set 1 trimmed ref pointer*. For example, if EXT1 control mode is used and the reference source is *AI1 scaled*, then *22.11 Ext1 speed ref1* and *40.53 Set 1 trimmed ref pointer* shall be configured to *AI1 scaled*.

The *40.05 Process PID trim output act* is calculated using the following formula:

The following graph shows the trim increase in combined mode.

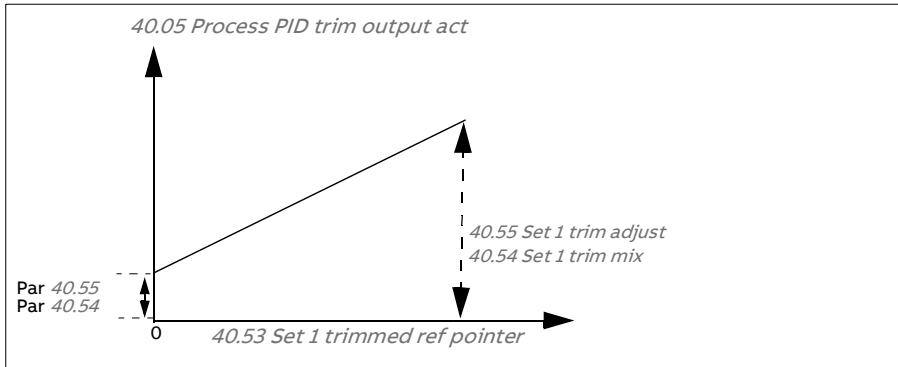

Note: In the above graph, it is assumed that the PID output is limited or stable at 100. This is for clarity only. In real life scenarios, PID output can vary based on the setpoint and actual.

At zero speed, the *40.05 Process PID trim output act* value depends on both parameters *40.54 Set 1 trim mix* and *40.55 Set 1 trim adjust*. However, adjusting *40.54 Set 1 trim mix* near to zero speed will give quick correction.

Example:

If:

- parameter *40.52 Set 1 trim selection* = *Speed*
- parameter *40.56 Set 1 trim source* = *PID output*
- parameter *30.12 Maximum speed* = *1500 rpm*
- parameter *40.53 Set 1 trimmed ref pointer* = *All scaled*
- parameter *22.11 Ext1 speed ref1* = *All scaled*
- parameter *12.20 All scaled at All max* = *1500*
- parameter *12.12 All scaled value* = *750* (All actual scaled value)
- parameter *40.01 Process PID output actual* = *100* (limited to 100)
- parameter *40.54 Set 1 trim mix* = *0.1*
- parameter *40.55 Set 1 trim adjust* = *1*

Then:

If *12.12 All scaled value* is 0:

$$\text{Par40.05} = (100/100) \times \{(1500 \times 0.1) + [(1 - 0.1) \times 0]\} \times 1$$

$$\text{Par40.05} = 150$$

If *12.12 All scaled value* is 750:

$$\text{Par40.05} = (100/100) \times \{(1500 \times 0.1) + [(1 - 0.1) \times 750]\} \times 1$$

$$\text{Par40.05} = 825$$

If *12.12 AI1 scaled value* is 1500:

$$\text{Par40.05} = (100/100) \times \{ (1500 \times 0.1) + [(1 - 0.1) \times 1500] \} \times 1$$

$$\text{Par40.05} = 1500$$

Pid trim auto connection

Parameter *40.65 Trim auto connection* activates the connection of PID trim output actual (parameter *40.05 Process PID trim output act*) to the respective speed, torque and frequency reference chains. The respective reference chains can be selected with parameter *40.52 Set 1 trim selection* (for PID set 1) or *40.52 Set 2 trim selection* (for PID set 2).

Parameter *99.04 Motor control mode* is also taken into consideration while passing the PID trimmed output actual (*40.05 Process PID trim output act*) to the speed, torque and frequency reference chains. In scalar control mode, the speed trim and torque trim values are zero and in vector control mode, the frequency trim value is zero.

Speed trim connection

Speed trim is added at *23.02 Speed ref ramp output* and *24.11 Speed correction* and the final speed reference after the trim addition is available in parameter *24.01 Used speed reference*.

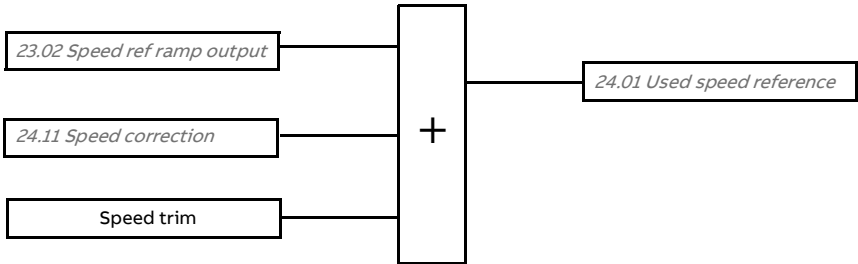

Torque trim connection

Torque trim is added at *26.75 Torque reference act 5* and the final torque reference after the trim addition is available in parameter *26.76 Torque reference act 6*.

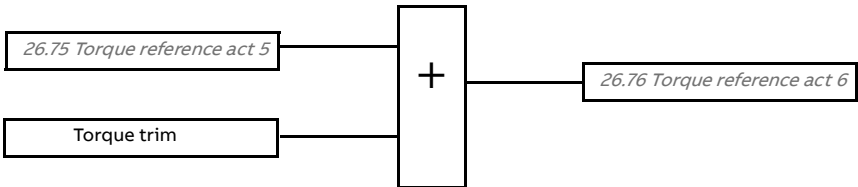

Frequency trim connection

Frequency trim is added at 28.02 Frequency ref ramp out and the final frequency reference is generated after the trim addition. At the moment, no parameter is available to see the final frequency reference after adding frequency trim.

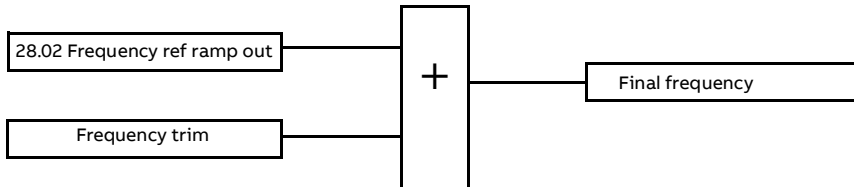

Note: PID trim output auto connection is disabled in the firmware when the drive is stopped with the *21.04 Emergency stop mode* value *Ramp stop (Off1)* or value *Eme ramp stop (Off3)*. In other words, PID trim output actual (*40.05 Process PID trim output act*) will not be added to the respective speed, torque and frequency reference chains during ramp stop or emergency stop.

■ Mechanical brake control

A mechanical brake can be used for holding the motor and driven machinery at zero speed when the drive is stopped, or not powered. The brake control logic observes the settings of parameter group *44 Mechanical brake control* as well as several external signals, and moves between the states presented in the diagram on page 85. The tables below the state diagram detail the states and transitions. The timing diagram on page 86 shows an example of a close-open-close sequence.

Inputs of the brake control logic

The start command of the drive (bit 5 of *06.16 Drive status word 1*) is the main control source of the brake control logic.

Outputs of the brake control logic

The mechanical brake is controlled by bit 0 of parameter *44.01 Brake control status*. This bit should be selected as the source of a relay output (or a digital output) which is then wired to the brake actuator through a relay. See the wiring example on page 87.

The brake control logic, in various states, will request the drive control logic to hold the motor, or ramp down the speed. These requests are visible in parameter *44.01 Brake control status*.

Brake state diagram

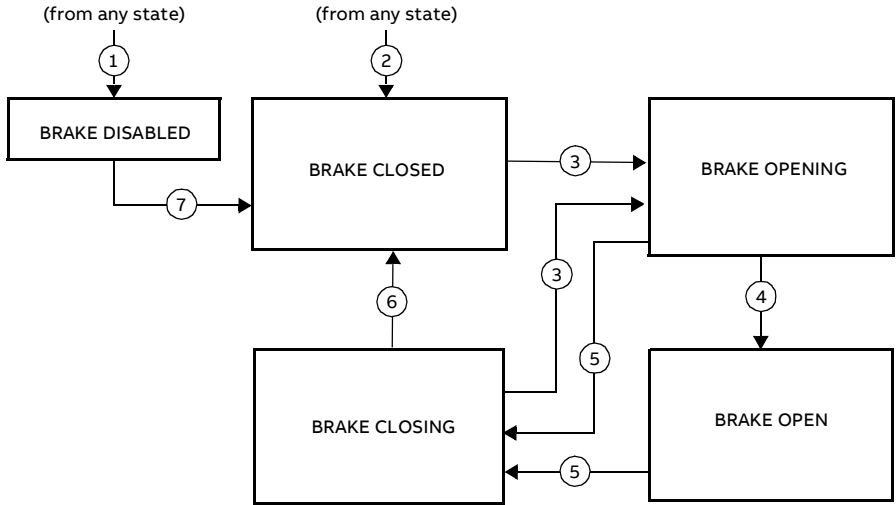

State descriptions

State name	Description
<i>BRAKE DISABLED</i>	Brake control is disabled (parameter <i>44.06 Brake control enable</i> = 0, and <i>44.01 Brake control status b4</i> = 0). Brake open command signal is deactivated (<i>44.01 Brake control status b0</i> = 0).
<i>BRAKE OPENING</i>	Brake has been requested to open. (<i>44.01 Brake control status b2</i> = 1). Brake open command signal has been activated (<i>44.01 Brake control status b0</i> = 1). The load is held in place by the speed control of the drive until <i>44.08 Brake open delay</i> elapses.
<i>BRAKE OPEN</i>	The brake is open (<i>44.01 Brake control status b0</i> = 1). Hold request is removed (<i>44.01 Brake control status b2</i> = 0), and the drive is allowed to follow the reference.
<i>BRAKE CLOSING</i>	Closing conditions have been met. The open signal is deactivated (<i>44.01 Brake control status b0</i> → 0). The ramp-down request is maintained (<i>44.01 Brake control status b3</i> = 1). The brake logic will remain in this state until <i>44.13 Brake close delay</i> has elapsed. At this point, the logic proceeds to <i>BRAKE CLOSED</i> state.
<i>BRAKE CLOSED</i>	The brake is closed (<i>44.01 Brake control status b0</i> = 0). The drive is not necessarily modulating.

State change conditions (\textcircled{n})

- 1 Brake control disabled (parameter 44.06 Brake control enable \rightarrow 0).
- 2 06.11 Main status word, bit 2 = 0.
- 3 Brake has been requested to open.
- 4 44.08 Brake open delay has elapsed.
- 5 Brake has been requested to close.
- 6 44.13 Brake close delay has elapsed.
- 7 Brake control enabled (parameter 44.06 Brake control enable \rightarrow 1).

Timing diagram

The simplified timing diagram below illustrates the operation of the brake control function. Refer to the state diagram above.

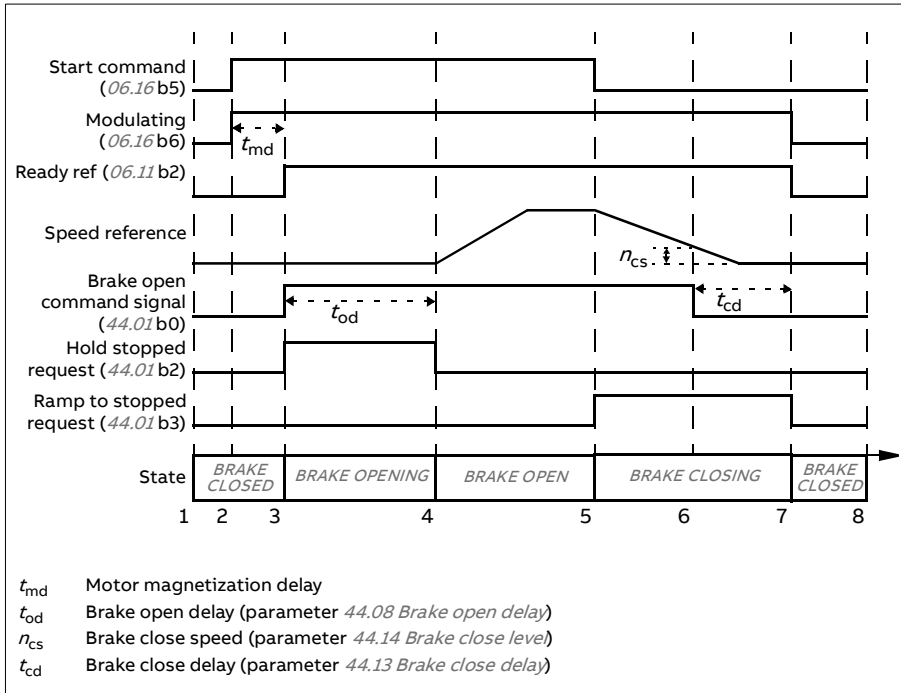

Wiring example

The figure below shows a brake control wiring example. The brake control hardware and wiring is to be sourced and installed by the customer.



WARNING! Make sure that the machinery into which the drive with brake control function is integrated fulfills the personnel safety regulations. Note that the frequency converter (a Complete Drive Module or a Basic Drive Module, as defined in IEC/EN 61800-2), is not considered as a safety device mentioned in the European Machinery Directive and related harmonized standards. Thus, the personnel safety of the complete machinery must not be based on a specific frequency converter feature (such as the brake control function), but it has to be implemented as defined in the application specific regulations.

The brake is controlled by bit 0 of parameter *44.01 Brake control status*. In this example, parameter *10.24 RO1 source* is set to *Brake command* (ie. bit 0 of *44.01 Brake control status*).

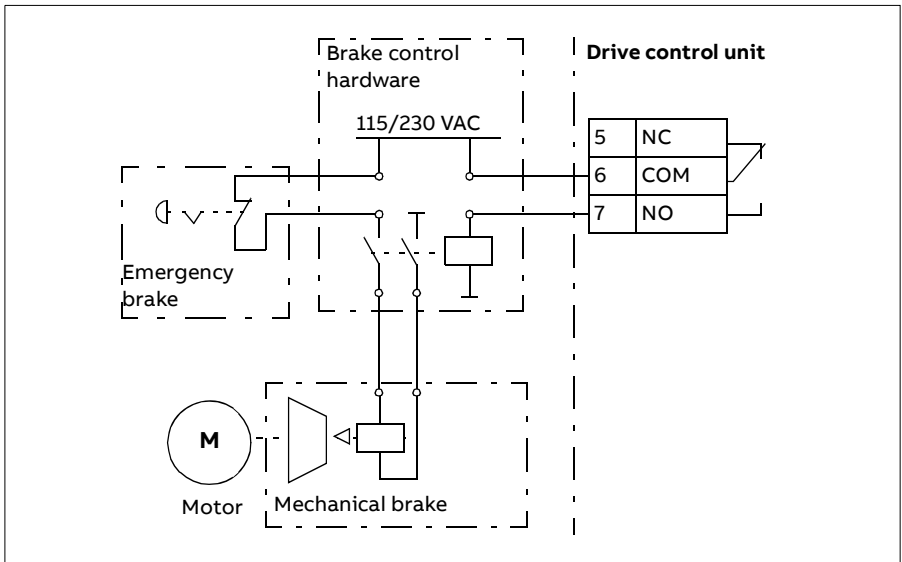

DC voltage control

■ Overvoltage control

Overvoltage control of the intermediate DC link is typically needed when the motor is in generating mode. The motor can generate when it decelerates or when the load overhauls the motor shaft, causing the shaft to turn faster than the applied speed or frequency. To prevent the DC voltage from exceeding the overvoltage control limit, the overvoltage controller automatically decreases the generating torque when the limit is reached. The overvoltage controller also increases any programmed deceleration times if the limit is reached; to achieve shorter deceleration times, a brake chopper and resistor may be required (ACS180 drives have no brake chopper support).

■ Undervoltage control (power loss ride-through)

If the incoming supply voltage is cut off, the drive will continue to operate by utilizing the kinetic energy of the rotating motor. The drive will be fully operational as long as the motor rotates and generates energy to the drive. The drive can continue operation after the break if the main contactor (if present) remained closed.

Note: Units equipped with a main contactor must be equipped with a hold circuit (e.g. UPS) to keep the contactor control circuit closed during a short supply break.

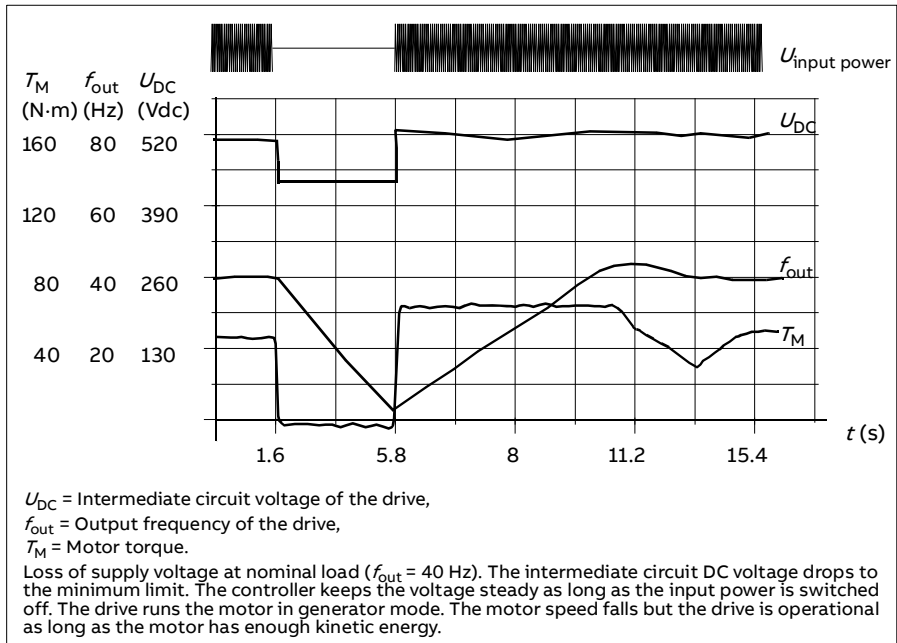

Implementing the undervoltage control (power loss ride-through)

Implement the undervoltage control function as follows:

- Check that the undervoltage control function of the drive is enabled with parameter *30.31 Undervoltage control*.
- Parameter *21.01 Start mode* must be set to *Automatic* (in vector mode) or parameter *21.19 Scalar start mode* to *Automatic* (in scalar mode) to make flying start (starting into a rotating motor) possible.

If the installation is equipped with a main contactor, prevent its tripping at the input power break. For example, use a time delay relay (hold) in the contactor control circuit.



WARNING! Make sure that the flying restart of the motor will not cause any danger. If you are in doubt, do not implement the undervoltage control function.

■ Voltage control and trip limits

The control and trip limits of the intermediate DC voltage regulator are relative to the supply voltage as well as drive/inverter type. The DC voltage (U_{DC}) is approximately 1.41 times the line-to-line supply voltage, and is displayed by parameter *01.11 DC voltage*.

The following table shows the values of the selected DC voltage levels in volts. Note that the absolute voltages vary according to drive/inverter type and AC supply voltage range.

When adaptive voltage limit is enabled in parameter *95.02*:

DC voltage level [V]	95.01 Supply Voltage			
	AC supply voltage range [V] 208...240	AC supply voltage range [V] 380...415	AC supply voltage range [V] 440...480	Automatic / Not selected
Overvoltage fault limit	421	842	842	842
Overvoltage control limit	389	779	779	779
Internal brake chopper start limit	389	760	760	760
Internal brake chopper stop limit	379	745	745	745
Overvoltage warning limit	372	745	745	745
Undervoltage warning limit	$0.85 \times 1.41 \times \text{par } 95.03 \text{ value } ^1$ $0.85 \times 1.41 \times 208 = 249 ^2$	$0.85 \times 1.41 \times \text{par } 95.03 \text{ value } ^1$ $0.85 \times 1.41 \times 380 = 455 ^2$	$0.85 \times 1.41 \times \text{par } 95.03 \text{ value } ^1$ $0.85 \times 1.41 \times 440 = 527 ^2$	$0.85 \times 1.41 \times \text{par } 95.03 \text{ value } ^1$

DC voltage level [V]	95.01 Supply Voltage			
See 95.01 Supply voltage.	AC supply voltage range [V] 208...240	AC supply voltage range [V] 380...415	AC supply voltage range [V] 440...480	Automatic / Not selected
Undervoltage control limit	0.78×1.41×par 95.03 value ¹⁾ 0.78×1.41×208 = 229 ²⁾	0.78×1.41×par 95.03 value ¹⁾ 0.78×1.41×380 = 418 ²⁾	0.78×1.41×par 95.03 value ¹⁾ 0.78×1.41×440 = 484 ²⁾	0.78×1.41×par 95.03 value ¹⁾
Charging relay closing limit / charging deactivation	0.78×1.41×par 95.03 value ¹⁾ 0.78×1.41×208 = 229 ²⁾	0.78×1.41×par 95.03 value ¹⁾ 0.78×1.41×380 = 418 ²⁾	0.78×1.41×par 95.03 value ¹⁾ 0.78×1.41×440 = 484 ²⁾	0.78×1.41×par 95.03 value ¹⁾
Charging relay opening limit / charging activation	0.73×1.41×par 95.03 value ¹⁾ 0.73×1.41×208 = 214 ²⁾	0.73×1.41×par 95.03 value ¹⁾ 0.73×1.41×380 = 391 ²⁾	0.73×1.41×par 95.03 value ¹⁾ 0.73×1.41×440 = 453 ²⁾	0.73×1.41×par 95.03 value ¹⁾
DC voltage at upper bound of supply voltage range (U_{DCmax})	324	560	648	(variable)
DC voltage at lower bound of supply voltage range (U_{DCmin})	281	513	594	(variable)
Charging activation/standby limit	0.73×1.41×par 95.03 value ¹⁾ 0.73×1.41×208 = 214 ²⁾	0.73×1.41×par 95.03 value ¹⁾ 0.73×1.41×380 = 391 ²⁾	0.73×1.41×par 95.03 value ¹⁾ 0.73×1.41×440 = 453 ²⁾	0.73×1.41×par 95.03 value ¹⁾
Undervoltage fault limit	0.73×1.41×par 95.03 value ¹⁾ 0.73×1.41×208 = 214 ²⁾	0.73×1.41×par 95.03 value ¹⁾ 0.73×1.41×380 = 391 ²⁾	0.73×1.41×par 95.03 value ¹⁾ 0.73×1.41×440 = 453 ²⁾	0.73×1.41×par 95.03 value ¹⁾
¹⁾ If parameter 95.01 Supply voltage is set to <i>Automatic / not selected</i> and 95.02 Adaptive voltage limits is set to <i>Enable</i> , the value of parameter 95.03 Estimated AC supply voltage is used, ²⁾ otherwise the lower limit of the range selected with parameter 95.01 Supply voltage is used.				

When adaptive voltage limit is disabled in parameter *95.02*:

DC voltage level [V]	95.01 Supply Voltage				
	AC supply voltage range [V] 208...240	AC supply voltage range [V] 380...415	AC supply voltage range [V] 440...480	Automatic / Not selected	
				if <i>95.03</i> < 456AC	if <i>95.03</i> > 456AC
Overvoltage fault limit	421	842	842	842	842
Overvoltage control limit	389	779	779	779	779
Internal brake chopper start limit	389	779	779	779	779
Internal brake chopper start limit	379	759	759	759	759
Overvoltage warning limit	372	745	745	745	745
Undervoltage warning limit	$0.85 \times 1.35 \times 208 = 239$	$0.85 \times 1.35 \times 380 = 436$	$0.85 \times 1.35 \times 440 = 505$	$0.85 \times 1.35 \times 380 = 436$	$0.85 \times 1.35 \times 440 = 505$
Undervoltage control limit	$0.78 \times 1.35 \times 208 = 219$	$0.78 \times 1.35 \times 380 = 400$	$0.78 \times 1.35 \times 440 = 463$	$0.78 \times 1.35 \times 180 = 400$	$0.78 \times 1.35 \times 440 = 463$
Charging relay closing limit	$0.78 \times 1.35 \times 208 = 219$	$0.78 \times 1.35 \times 380 = 400$	$0.78 \times 1.35 \times 440 = 463$	$0.78 \times 1.35 \times 180 = 400$	$0.78 \times 1.35 \times 440 = 463$
Charging relay opening limit	$0.73 \times 1.35 \times 208 = 205$	$0.73 \times 1.35 \times 380 = 374$	$0.73 \times 1.35 \times 440 = 434$	$0.73 \times 1.35 \times 380 = 374$	$0.73 \times 1.35 \times 440 = 434$
DC voltage at upper bound of supply voltage range (U_{DCmax})	324	560	648	(variable)	(variable)
DC voltage at lower bound of supply voltage range (U_{DCmin})	281	513	594	(variable)	(variable)
Charging activation/standby limit	$0.73 \times 1.35 \times 208 = 205$	$0.73 \times 1.35 \times 380 = 374$	$0.73 \times 1.35 \times 440 = 434$	$0.73 \times 1.35 \times 380 = 374$	$0.73 \times 1.35 \times 440 = 434$
Undervoltage fault limit	$0.73 \times 1.35 \times 208 = 205$	$0.73 \times 1.35 \times 380 = 374$	$0.73 \times 1.35 \times 440 = 434$	$0.73 \times 1.35 \times 380 = 374$	$0.73 \times 1.35 \times 440 = 434$

■ Settings and diagnostics

Parameters *01.11 DC voltage* (page 111), *30.30 Overvoltage control* (page 210), *30.31 Undervoltage control* (page 210), *95.01 Supply voltage* (page 293) and *95.02 Adaptive voltage limits* (page 293).

Events: -

Safety and protections

■ Fixed/Standard protections

Overcurrent

If the output current exceeds the internal overcurrent limit, the IGBTs are shut down immediately to protect the drive.

DC overvoltage

See section *Overvoltage control* on page 88.

DC undervoltage

See section *Undervoltage control (power loss ride-through)* on page 88.

Drive temperature

If the temperature rises high enough, the drive first starts to limit the switching frequency and then the current to protect itself. If it is still keeps heating up, for example because of a fan failure, an overtemperature fault is generated.

Short circuit

In case of a short circuit, the IGBTs are shut down immediately to protect the drive.

Earth (Ground) fault detection

Note that

- an earth fault in the supply cable does not activate the protection
- in a grounded supply, the protection activates within 2 milliseconds
- in an ungrounded supply, the supply capacitance must be 1 microfarad or more
- the capacitive currents caused by shielded motor cables up to 300 meters will not activate the protection

the protection is deactivated when the drive is stopped.

■ Emergency stop

The emergency stop signal is connected to the input selected by parameter *21.05 Emergency stop source*. An emergency stop can also be generated through fieldbus (parameter *06.01 Main control word*, bits 0...2).

The mode of the emergency stop is selected by parameter *21.04 Emergency stop mode*. The following modes are available:

- Off1: Stop along the standard deceleration ramp defined for the particular reference type in use
- Off2: Stop by coasting
- Off3: Stop by the emergency stop ramp defined by parameter *23.23 Emergency stop time*.

With Off1 or Off3 emergency stop modes, the ramp-down of the motor speed can be supervised by parameters *31.32 Emergency ramp supervision* and *31.33 Emergency ramp supervision delay*.

Notes:

- The installer of the equipment is responsible for installing the emergency stop devices and all additional devices needed for the emergency stop function to fulfill the required emergency stop categories.
- After an emergency stop signal is detected, the emergency stop function cannot be canceled even though the signal is canceled.
- If the minimum (or maximum) torque limit is set to 0%, the emergency stop function may not be able to stop the drive.
- During an emergency stop, the speed and torque reference parameters such as reference ramp shapes (*23.32 Shape time 1* and *23.33 Shape time 2*) are not considered.

Settings and diagnostics

Parameters *21.04 Emergency stop mode* (page 159), *21.05 Emergency stop source* (page 159), *23.23 Emergency stop time* (page 179), *31.32 Emergency ramp supervision* (page 219) and *31.33 Emergency ramp supervision delay* (page 220).

Events: -

■ Motor thermal protection

The control program features two separate motor temperature monitoring functions. The temperature data sources and warning/trip limits can be set up independently for each function.

The motor temperature can be monitored using

- the motor thermal protection model (estimated temperature derived internally inside the drive), or
- sensors installed in the windings. This will result in a more accurate motor model.

The motor thermal protection model fulfills standard IEC/EN 61800-5-1 ed. 2.1 requirements for thermal memory retention and speed sensitivity.

The estimated temperature is retained over power down. Speed dependency is set by parameters.

Note: The motor thermal model can be used when only one motor is connected to the drive.

Motor thermal protection model

The drive calculates the temperature of the motor on the basis of the following assumptions:

1. When power is applied to the drive for the first time, the motor is assumed to be at ambient temperature (defined by parameter *35.50 Motor ambient temperature*). After this, when power is applied to the drive, the motor is assumed to be at the estimated temperature.
2. Motor temperature is calculated using the user-adjustable motor thermal time and motor load curve. The load curve should be adjusted in case the ambient temperature exceeds 30 °C.

Note: The motor thermal model can be used when only one motor is connected to the inverter.

Sensor insulation and connection

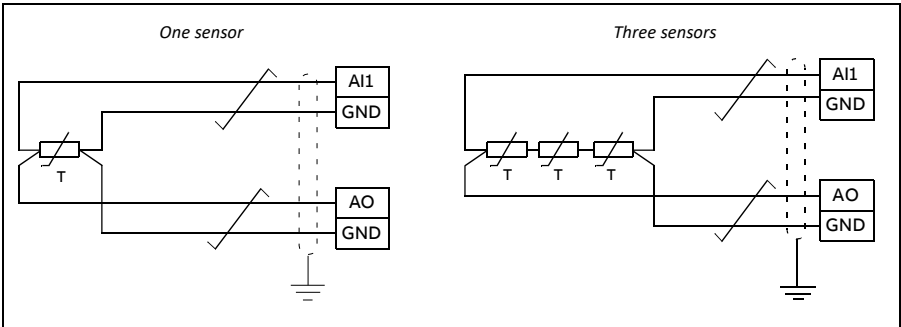
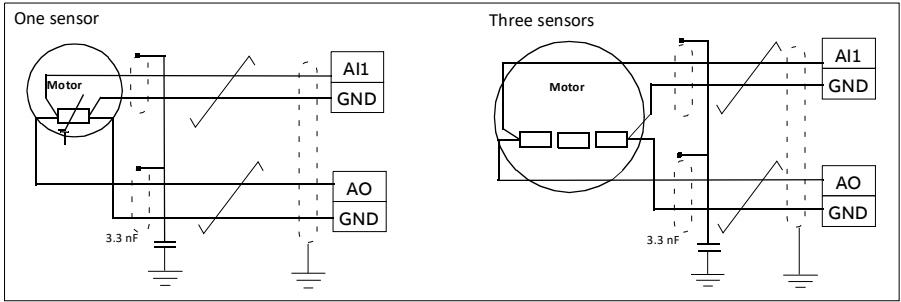

⚠ WARNING! IEC 60664 requires double or reinforced insulation between live parts and the surface of accessible parts of electrical equipment which are either non-conductive or conductive but not connected to the protective earth.

To fulfill this requirement, connect a thermistor to the drive's control terminals using any of these alternatives:

- Separate the thermistor from live parts of the motor with double reinforced insulation.
- Protect all circuits connected to the drive's digital and analog inputs. Protect against contact, and insulate from other low voltage circuits with basic insulation (rated for the same voltage level as the drive's main circuit).
- Use an external thermistor relay. The relay insulation must be rated for the same voltage level as the drive's main circuit.

Temperature monitoring using Pt100 sensors

1...3 Pt100 sensors can be connected in series to an analog input and an analog output.

The analog output feeds a constant excitation current of 9.1 mA through the sensor. The sensor resistance increases as the motor temperature rises, as does the voltage over the sensor. The temperature measurement function reads the voltage through the analog input and converts it into degrees Celsius.

It is possible to adjust the motor temperature supervision limits and select how the drive reacts when overtemperature is detected.

For the wiring of the sensor, see the *Hardware manual* of the drive.

Settings and diagnostics

Parameter group *35 Motor thermal protection* (page 234).

Events: -

■ Automatic fault resets

The drive can automatically reset itself after overcurrent, overvoltage, undervoltage and external faults. The user can also specify a fault that is automatically reset.

By default, automatic resets are off and must be specifically activated by the user.



WARNING! Before you activate the function, make sure that no dangerous situations can occur. The function resets the drive automatically and continues operation after a fault.

Settings and diagnostics

Parameters *31.12...31.16*.

Events: -

■ Other programmable protection functions

External events (parameters *31.01...31.10*)

Five different event signals from the process can be connected to selectable inputs to generate trips and warnings for the driven equipment. When the signal is lost, an external event (fault, warning, or a mere log entry) is generated.

Motor phase loss detection (parameter 31.19)

The parameter selects how the drive reacts whenever a motor phase loss is detected.

The motor phase loss detection is enabled by default and displays fault *3381 Output phase loss* whenever the drive detects a phase loss. The motor phase loss detection needs to be enabled or disabled based on the motor control mode and the nominal current as follows:

- With the vector control, the motor phase loss detection is always on and there are no operational limits.
- With the scalar control, the motor phase loss detection activates when the motor frequency is above 10% of the motor nominal frequency. This limit cannot be changed.
- With motors having nominal current below 1/6 of drive nominal current, the supervision must be disabled as the drive cannot measure the motor current accurately.

Earth (Ground) fault detection (parameter 31.20)

Note that

- an earth fault in the supply cable does not activate the protection
- in a grounded supply, the protection activates within 2 milliseconds
- the protection is deactivated when the drive is stopped.

Safe torque off detection (Only on ACS180-04S-... type, parameter 31.22)

The drive monitors the status of the Safe torque off input, and this parameter selects which indications are given when the signals are lost. (The parameter does not affect the operation of the Safe torque off function itself). For more information on the Safe torque off function, see the hardware manual of the drive.

Swapped supply and motor cabling (parameter 31.23)

The drive can detect if the supply and motor cables have accidentally been swapped (for example, if the supply is connected to the motor connection of the drive). The parameter selects if a fault is generated or not.

Stall protection (parameters 31.24...31.28)

The drive protects the motor in a stall situation. It is possible to adjust the supervision limits (current, frequency and time) and choose how the drive reacts to a motor stall condition.

Overspeed protection (parameter 31.30)

The user can set overspeed (and overfrequency) limits by specifying a margin that is added to the currently-used maximum and minimum speed (or frequency) limits.

Local control loss detection (parameter 49.05)

The parameter selects how the drive reacts to a control panel or PC tool communication break.

AI supervision (parameters 12.03...12.05)

The parameters select how the drive reacts when an analog input signal moves out of the minimum and/or maximum limits specified for the input.

Ramp stop supervision (parameters 31.32 and 31.33)

The control program has a supervision function for both the normal and emergency stop ramps. The user can either define a maximum time for stopping, or a maximum deviation from the expected deceleration rate. If the drive fails to stop in the expected manner, a fault is generated and the drive coasts to a stop.

Custom motor current fault limit (parameter 31.30)

The control program sets a motor current limit based on drive hardware. In most cases, the default value is appropriate. However, a lower limit can be manually set by the user, for example, to protect a permanent magnet motor from demagnetization.

Diagnostics

■ Fault and warning messages, data logging

See chapter *Fault tracing* (page 353).

■ Signal supervision

Six signals can be selected to be supervised by this function. Whenever a supervised signal exceeds or falls below predefined limits, a bit in *32.01 Supervision status* is activated, and a warning or fault generated.

The supervised signal is low-pass filtered.

Settings and diagnostics

Parameter group *32 Supervision* (page 221).

Events: -

■ Energy saving calculators

This feature consists of the following functionalities:

- An energy optimizer that adjusts the motor flux in such a way that the total system efficiency is maximized
- A counter that monitors used and saved energy by the motor and displays them in kWh, currency or volume of CO₂ emissions, and
- A load analyzer showing the load profile of the drive (see section *Load analyzer* on page 100).

In addition, there are counters that show energy consumption in kWh of the current and previous hour as well as the current and previous day.

Note: The accuracy of the energy savings calculation is directly dependent on the accuracy of the reference motor power given in parameter *45.19 Comparison power*.

Settings and diagnostics

Parameter group *45 Energy efficiency* (page 269).

Parameters *01.50 Current hour kWh* (page 112), *01.51 Previous hour kWh* (page 113), *01.52 Current day kWh* (page 113) and *01.53 Previous day kWh* (page 113).

Events: -

■ Load analyzer

Peak value logger

The user can select a signal to be monitored by a peak value logger. The logger records the peak value of the signal along with the time the peak occurred, as well as motor current, DC voltage and motor speed at the time of the peak. The peak value is sampled at 2 ms intervals.

Amplitude loggers

The control program has two amplitude loggers.

For amplitude logger 2, the user can select a signal to be sampled at 200 ms intervals, and specify a value that corresponds to 100%. The collected samples are sorted into 10 read-only parameters according to their amplitude.

- Parameter 1 shows the share of samples that have fallen in range 0...10% of the reference value during the time that the logging has been active.
- Parameter 2 shows that share of samples that have fallen in range 10...20% of the reference value during the time that the logging has been active
- etc.

You can view this graphically with the assistant panel or the Drive composer PC tool.

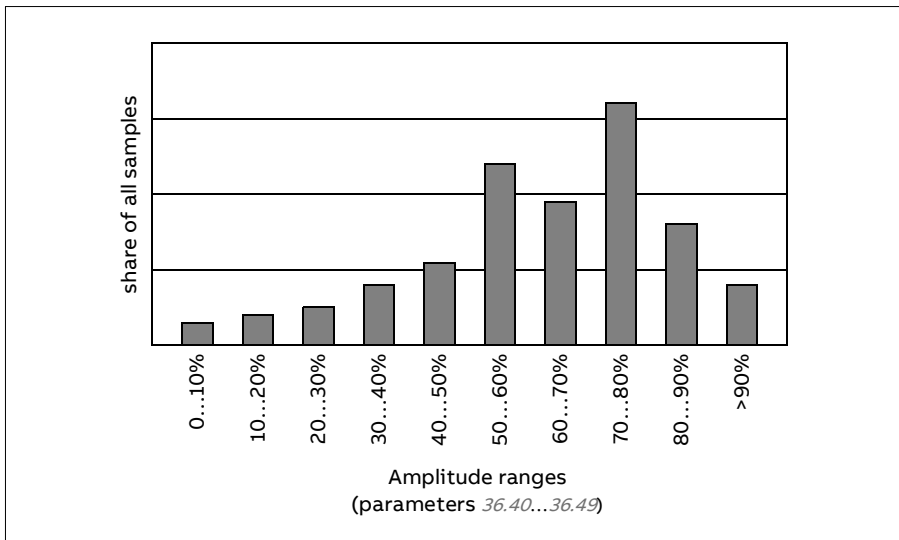

Amplitude logger 1 is fixed to monitor motor current, and cannot be reset. With amplitude logger 1, 100% corresponds to the maximum output current of the drive (I_{\max}). The maximum output current values are listed in the section

Ratings in the *Hardware manual* of the drive. The measured current is logged continuously. The distribution of samples is shown by parameters *36.20...36.29*.

Settings and diagnostics

Parameter group *36 Load analyzer* (page *240*).

Events: -

Miscellaneous

■ Backup and restore

You can make backups of the settings manually to the assistant panel. The panel also keeps one automatic backup. You can restore a backup to another drive, or a new drive replacing a faulty one. You can make backups and restore on the panel, or with the Drive composer PC tool.

See the relevant assistant control panel for more information on backing up and settings.

Backup

Manual backup

Make a backup when necessary, for example, after you have started up the drive or when you want to copy the settings to another drive.

Parameter changes from fieldbus interfaces are ignored unless you have forced parameter saving.

Automatic backup

The assistant panel has space for one automatic backup. An automatic backup is created two hours after the last parameter change. After completing the backup, the panel waits for 24 hours before checking if there are additional parameter changes. If there are, it creates a new backup overwriting the previous one when two hours have passed after the latest change.

You cannot adjust the delay time or disable the automatic backup function.

Parameter changes from fieldbus interfaces are ignored unless you have forced parameter saving.

Restore

The backups are shown on the panel. Automatic and manual backups are separately marked.

Note: To restore a backup, the drive has to be in Local control.

Settings and diagnostics

Parameter *96.07 Parameter save manually* (page 298).

Events: -

■ User parameter sets

The drive supports four user parameter sets that can be saved to the permanent memory and recalled using drive parameters. It is also possible to

use digital inputs to switch between user parameter sets. To change a user parameter set, the drive has to be stopped.

A user parameter set contains all editable values in parameter groups 10...99 except Data storage parameters (*47 Data storage*).

As the motor settings are included in the user parameter sets, make sure the settings correspond to the motor used in the application before recalling a user set. In an application where different motors are used with the drive, the motor ID run needs to be performed with each motor and the results saved to different user sets. The appropriate set can then be recalled when the motor is switched.

Settings and diagnostics

Parameters *96.10...96.13*.

Events: -

■ Data storage parameters

Twelve (eight 32-bit, four 16-bit) parameters are reserved for data storage. These parameters are unconnected by default and can be used for linking, testing and commissioning purposes. They can be written to and read from using other parameters' source or target selections.

Settings and diagnostics

Parameter group *47 Data storage* (page 277).

Events: -

■ Parameter checksum calculation

Parameter checksums A and B can be calculated from a set of parameters to monitor changes in the drive configuration. The parameter sets are different for A and B. Each of the calculated checksum is compared to corresponding reference checksum. If a mismatch occurs, the drive generates an event (a pure event, warning or fault). The calculated checksum can be set as the new reference checksum.

The set of parameters for checksum A does not include fieldbus settings parameters.

The parameters included in the checksum A calculation are user editable parameters in parameter groups 10, 15, 19, 20, 21, 22, 23, 24, 25, 28, 30, 31, 32, 35, 36, 37, 40, 41, 45, 46, 71, 95, 96, 97, 98, and 99.

The set of parameters for checksum B does not include:

- fieldbus settings
- motor data settings, and
- energy data settings parameters.

The parameters included in the checksum B calculation are user editable parameters in parameter groups 10, 15, 19, 20, 21, 22, 23, 24, 25, 28, 30, 31, 32, 35, 36, 37, 40, 41, 46, 71, 95, 96, and 97.

Settings and diagnostics

Parameters *96.54...96.55*, *96.68...96.69* and *96.71...96.72*.

Events *A686 Checksum mismatch* (page 359), *B686 Checksum mismatch* (page 365) and *6200 Checksum mismatch* (page 370).

Events: -

■ Motor potentiometer

The motor potentiometer is a counter whose value can be adjusted up and down using two digital signals selected by parameters.

When enabled, the motor potentiometer assumes a set value. Depending on the mode selected, the motor potentiometer value is either retained or reset over a power cycle.

The change rate is defined as the time it would take for the value to change from the minimum to the maximum, or vice versa. If the up and down signals are simultaneously on, the motor potentiometer value does not change.

The output of the function is shown, and it can be directly set as the reference source in the main selector parameters, or used as an input by other source selector parameters.

The following example shows the behavior of the motor potentiometer value.

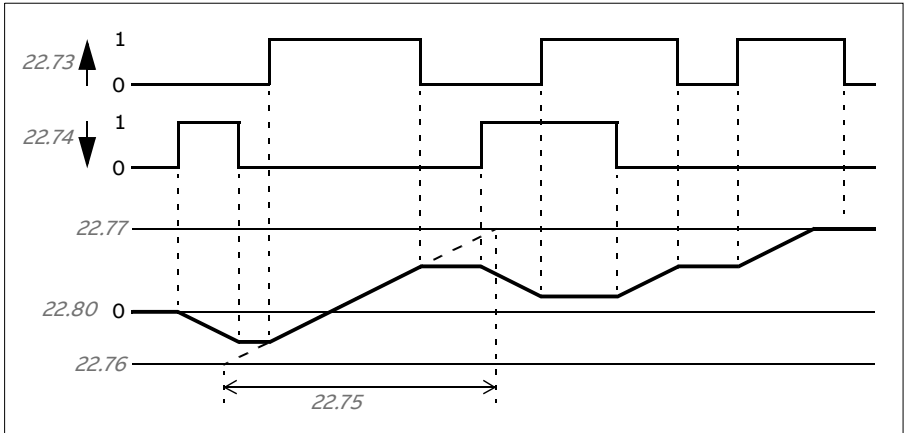

Settings and diagnostics

Parameters *22.71...22.80*.

Events: -

■ User lock

For better cybersecurity, you can set a master password to prevent eg. the changing of parameter values and/or the loading of firmware and other files.



WARNING! ABB will not be liable for damages or losses caused by the failure to activate the user lock using a new pass code. See *Cybersecurity disclaimer* (page 14).



WARNING! Store the pass code in a safe place – the user lock cannot be opened even by ABB if the pass code is lost.

To activate the user lock for the first time, enter the default pass code, 10000000, into *96.02 Pass code*. This will make parameters *96.100...96.102* visible. Then enter a new pass code into *96.100 Change user pass code*, and confirm the code in *96.101 Confirm user pass code*. In *96.102 User lock functionality*, define the actions that you want to prevent.

To close the user lock, enter an invalid pass code into *96.02 Pass code*, activate *96.08 Control board boot*, or cycle the power. With the lock closed, parameters *96.100...96.102* are hidden.

To reopen the lock, enter your pass code into *96.02 Pass code*. This will again make parameters *96.100...96.102* visible.

Settings and diagnostics

Parameters *96.02 Pass code* (page 295) and *96.100...96.102*.

Events: -

■ AI dead band

User can define a dead band value (*12.110*) for the analog input signals. The value is valid both for analog input AI1 and AI2, and both for the voltage and milliampere signals. The dead band value of 100% corresponds to 10 V for a voltage signal and 20 mA for a current signal.

- In case of voltage: $10 \text{ V} \times (\text{parameter } 12.110 \text{ value}) \times 0.01$
- In case of current: $20 \text{ mA} \times (\text{parameter } 12.110 \text{ value}) \times 0.01$

The control program automatically calculates a hysteresis value for the AI dead band:

- AI dead band hysteresis value = AI dead band value \times 0.1

Example

Parameter *12.110 (AI dead band)* value is set to 50%.

In case of voltage signal:

- AI unit selection = V
- AI dead band value = $10 \times 50 \times 0.01 = 5 \text{ V}$
- AI Hysteresis value = $5 \times 0.1 = 0.5 \text{ V}$
- Hysteresis positive value = $5 + 0.5 = 5.5 \text{ V}$
- Hysteresis negative value = $5 - 0.5 = 4.5 \text{ V}$

Now, when AI input voltage is increasing up to 5.5 V, AI actual shows 0. As soon as AI input voltage reaches 5.5 V, AI actual shows 5.5 V and continues to detect the AI input voltage up to AI max which is in range of 0 V to 10 V. When AI input voltage is decreasing, AI actual shows the actual AI applied up to 4.5 V. As soon as AI input goes below 4.5 V, AI actual shows 0 till input voltage reaches 0 V.



Parameters

What this chapter contains

- *Terms and abbreviations*
 - *Fieldbus addresses*
 - *Summary of parameter groups*
 - *Parameter listing*
 - *Differences in the default values between 50 Hz and 60 Hz supply frequency settings*
 - *Parameters supported by Modbus backwards compatibility with legacy drives*
-

Terms and abbreviations

Term	Definition
Actual signal	Signal measured or calculated by the drive. Usually can only be monitored but not adjusted; some counter-type signals can however be reset.
Def	The default is shown on the same row as the parameter name. The default value of a parameter for the Factory macro. For information on other macro-specific parameter values, see chapter <i>Control macros</i> .
FbEq16/32	The fieldbus equivalent for 16-bit and 32-bit. They are shown on the same row as the parameter range, or for each selection. A dash (-) indicates that the user cannot access the parameter in 16-bit format. 32-bit fieldbus equivalent: The scaling between the value shown on the panel and the integer used in communication when a 32-bit value is selected for transmission to an external system.
Other	The value is taken from another parameter. Choosing "Other" displays a parameter list in which the user can specify the source parameter.
Other [bit]	The value is taken from a specific bit in another parameter. The user selects the source from a parameter list.
Parameter	Either a user-adjustable operating instruction for the drive, or an <i>Actual signal</i> .
p.u.	Per unit
[parameter number]	Value of the parameter

Fieldbus addresses

Refer to *Fieldbus control through the embedded fieldbus interface (EFB)*.

Summary of parameter groups

Group	Contents	Page
01 Actual values	Basic signals for monitoring the drive.	111
03 Input references	Values of references received from various sources.	114
04 Warnings and faults	Information on warnings and faults that occurred last.	115
05 Diagnostics	Various run-time-type counters and measurements related to drive maintenance.	117
06 Control and status words	Drive control and status words.	120
07 System info	Drive hardware and firmware information.	126
10 Standard DI, RO	Configuration of digital inputs and relay outputs.	127
11 Standard DIO, FI, FO	Configuration of the digital input/outputs.	132
12 Standard AI	Configuration of standard analog inputs.	136
13 Standard AO	Configuration of standard analog outputs.	141
19 Operation mode	Selection of local and external control location sources and operating modes.	145
20 Start/stop/direction	Start/stop/direction and run/start/jog enable signal source selection; positive/negative reference enable signal source selection.	147
21 Start/stop mode	Start and stop modes; emergency stop mode and signal source selection; DC magnetization settings.	157
22 Speed reference selection	Speed reference selection; motor potentiometer settings.	166
23 Speed reference ramp	Speed reference ramp settings (programming of the acceleration and deceleration rates for the drive).	177
24 Speed reference conditioning	Speed error calculation; speed error window control configuration; speed error step.	181
25 Speed control	Speed controller settings.	182
26 Torque reference chain	Settings for the torque reference chain.	187
28 Frequency reference chain	Settings for the frequency reference chain.	192
30 Limits	Drive operation limits.	204
31 Fault functions	Configuration of external events; selection of behavior of the drive upon fault situations.	212
32 Supervision	Configuration of signal supervision functions 1...3.	221
35 Motor thermal protection	Motor thermal protection settings such as temperature measurement configuration, load curve definition and motor fan control configuration.	234
36 Load analyzer	Peak value and amplitude logger settings.	240
37 User load curve	Settings for user load curve.	244
40 Process PID set 1	Parameter values for process PID control.	248
41 Process PID set 2	A second set of parameter values for process PID control.	263
43 Brake chopper	Settings for the internal brake chopper.	265
44 Mechanical brake control	Configuration of mechanical brake control.	268
45 Energy efficiency	Settings for the energy saving calculators.	269

110 Parameters

Group	Contents	Page
<i>46 Monitoring/scaling settings</i>	Speed supervision settings; actual signal filtering; general scaling settings.	<i>274</i>
<i>47 Data storage</i>	Data storage parameters that can be written to and read from using other parameters' source and target settings.	<i>277</i>
<i>49 Panel port communication</i>	Communication settings for the control panel port on the drive.	<i>278</i>
<i>58 Embedded fieldbus</i>	Configuration of the embedded fieldbus (EFB) interface.	<i>281</i>
<i>71 External PID1</i>	Configuration of external PID.	<i>290</i>
<i>95 HW configuration</i>	Various hardware-related settings.	<i>293</i>
<i>96 System</i>	Language selection; access levels; macro selection; parameter save and restore; control unit reboot; user parameter sets; unit selection; parameter checksum calculation; user lock.	<i>295</i>
<i>97 Motor control</i>	Switching frequency; slip gain; voltage reserve; flux braking; anti-cogging (signal injection); IR compensation.	<i>304</i>
<i>98 User motor parameters</i>	Motor values supplied by the user that are used in the motor model.	<i>310</i>
<i>99 Motor data</i>	Motor configuration settings.	<i>311</i>

Parameter listing

No.	Name/Value	Description	Default FbEq 16
<i>01 Actual values</i>		Basic signals for monitoring the drive. All parameters in this group are read-only unless otherwise noted. Note: Values of these actual signals are filtered with the filter time defined in group <i>46 Monitoring/scaling settings</i> . The selection lists for parameters in other groups mean the raw value of the actual signal instead. For example, if a selection is "Output frequency" it does not point to the value of parameter <i>01.06 Output frequency</i> but to the raw value.	
<i>01.01</i>	<i>Motor speed used</i>	Estimated motor speed. A filter time constant for this signal can be defined by parameter <i>46.11 Filter time motor speed</i> .	-
	-30000.00... 30000.00 rpm	Estimated motor speed.	See par. <i>46.01</i>
<i>01.03</i>	<i>Motor speed %</i>	Actual speed in percent of the motor synchronous speed. The filter time constant can be adjusted by parameter <i>46.11 Filter time motor speed</i> .	-
	-1000.00... 1000.00%	Motor speed.	See par. <i>46.01</i>
<i>01.06</i>	<i>Output frequency</i>	Estimated drive output frequency in Hz. A filter time constant for this signal can be defined by parameter <i>46.12 Filter time output frequency</i> .	-
	-500.00...500.00 Hz	Estimated output frequency.	See par. <i>46.02</i>
<i>01.07</i>	<i>Motor current</i>	Measured (absolute) motor current in A.	-
	0.00...30000.00	Motor current.	See par. <i>46.05</i>
<i>01.08</i>	<i>Motor current % of motor nom</i>	Motor current (drive output current) in percent of the nominal motor current.	-
	0.0...1000.0%	Motor current.	1=1%
<i>01.09</i>	<i>Motor current % of drive nom</i>	Motor current (drive output current) in percent of the nominal drive current.	-
	0.0...1000.0%	Motor current.	1=1%
<i>01.10</i>	<i>Motor torque</i>	Motor torque in percent of the nominal motor torque. See also parameter <i>01.30 Nominal torque scale</i> . A filter time constant for this signal can be defined by parameter <i>46.13 Filter time motor torque</i> .	-
	-1600.0...1600.0%	Motor torque.	See par. <i>46.03</i>
<i>01.11</i>	<i>DC voltage</i>	Measured intermediate circuit DC Link voltage.	-
	0.00...2000.00 V	DC link voltage.	10 = 1 V
<i>01.13</i>	<i>Output voltage</i>	Calculated motor voltage in V AC.	-
	0...2000 V	Motor voltage.	1 = 1 V

112 Parameters

No.	Name/Value	Description	Default FbEq 16
01.14	<i>Output power</i>	Measured output power in kW. The unit is selected by parameter <i>96.16 Unit selection</i> . The filter time constant can be adjusted by parameter <i>46.14 Filter time power</i> .	-
	-32768.00... 32767.00 kW	Output power.	See par. <i>46.04</i>
01.15	<i>Output power % of motor nom</i>	Measured output power in % of nominal motor power.	-
	-300.00... 300.00%	Output power.	10 = 1%
01.17	<i>Motor shaft power</i>	Estimated mechanical power at motor shaft in kW or hp. Parameter <i>96.16 Unit selection</i> defines the unit. The filter time constant can be adjusted by parameter <i>46.14 Filter time power</i> .	-
	-32768.00... 32767.00 kW or hp	Motor shaft power.	See par. <i>46.04</i>
01.18	<i>Inverter GWh counter</i>	Amount of energy that has passed through the drive (in either direction) in full gigawatt-hours. The minimum value is zero.	-
	0...65535 GWh	Energy in GWh.	1 = 1 GWh
01.19	<i>Inverter MWh counter</i>	Amount of energy that has passed through the drive (in either direction) in full megawatt-hours. Whenever the counter rolls over, <i>01.18 Inverter GWh counter</i> is incremented. The minimum value is zero.	-
	0...1000 MWh	Energy in MWh.	1 = 1 MWh
01.20	<i>Inverter kWh counter</i>	Amount of energy that has passed through the drive (in either direction) in full kilowatt-hours. Whenever the counter rolls over, <i>01.19 Inverter MWh counter</i> is incremented. The minimum value is zero.	-
	0...1000 kWh	Energy in kWh.	10 = 1 kWh
01.24	<i>Flux actual %</i>	Used flux reference in percent of nominal flux of motor.	-
	0...200%	Flux reference.	1 = 1%
01.30	<i>Nominal torque scale</i>	Nominal torque in N·m which corresponds to 100%. Note: This parameter is copied from parameter <i>99.12 Motor nominal torque</i> if given. Otherwise the value is calculated from other motor data.	0
	0.000...4000000 N·m or lb·ft	Nominal torque.	1 = 100 unit
01.50	<i>Current hour kWh</i>	Current hour energy consumption. This is the energy of the last 60 minutes (not necessarily continuous) the drive has been running, not the energy of a calendar hour. The value is set to the value before the power cycle when the drive is again up and running.	- / -
	0.00...1000000.00 kWh	Energy.	1 = 1 kWh

No.	Name/Value	Description	Default FbEq 16
01.51	<i>Previous hour kWh</i>	Previous hour energy consumption. The value <i>Current hour kWh</i> is stored here when its values has been cumulated for 60 minutes. The value is set to the value before the power cycle when the drive is again up and running.	-
	0.00...1000000.00 kWh	Energy.	1 = 1 kWh
01.52	<i>Current day kWh</i>	Current day energy consumption. This is the energy of the last 24 hours (not necessarily continuous) the drive has been running, not the energy of a calendar day. The value is set to the value before the power cycle when the drive is again up and running.	-
	0.00...1000000.00 kWh	Energy.	1 = 1 kWh
01.53	<i>Previous day kWh</i>	Previous day energy consumption. The value is set to the value before the power cycle when the drive is again up and running.	-
	0.00 ... 1000000.00 kWh	Energy.	1 = 1 kWh
01.54	<i>Cumulative inverter energy</i>	Amount of energy that has passed through the drive (in either direction) in full kilowatt-hours. The minimum value is zero.	-
	-200000000.0... 200000000.0 kWh	Energy in kWh.	10 = 1 kWh
01.55	<i>Inverter GWh counter (resettable)</i>	Amount of energy that has passed through the drive (in either direction) in full gigawatt-hours. The minimum value is zero. You can reset the value by setting it to zero. Resetting any of parameters 01.55...01.58 resets all of them.	-
	0...65535 GWh	Energy in GWh.	1 = 1 GWh
01.56	<i>Inverter MWh counter (resettable)</i>	Amount of energy that has passed through the drive (in either direction) in full megawatt-hours. Whenever the counter rolls over, 01.55 <i>Inverter GWh counter (resettable)</i> is incremented. The minimum value is zero. You can reset the value by setting it to zero. Resetting any of parameters 01.55...01.58 resets all of them.	-
	0...1000 MWh	Energy in MWh.	1 = 1 MWh
01.57	<i>Inverter kWh counter (resettable)</i>	Amount of energy that has passed through the drive (in either direction) in full kilowatt-hours. Whenever the counter rolls over, 01.56 <i>Inverter MWh counter (resettable)</i> is incremented. The minimum value is zero. You can reset the value by setting it to zero. Resetting any of parameters 01.55...01.58 resets all of them.	-
	0...1000 kWh	Energy in kWh.	10 = 1 kWh

114 Parameters

No.	Name/Value	Description	Default FbEq 16
01.58	<i>Cumulative inverter energy (resettable)</i>	Amount of energy that has passed through the drive (in either direction) in full kilowatt-hours. The minimum value is zero. You can reset the value by setting it to zero. Resetting any of parameters 01.55...01.58 resets all of them.	-
	-200000000.0... 200000000.0 kWh	Energy in kWh.	10 = 1 kWh
01.61	<i>Abs motor speed used</i>	Absolute value of the motor speed used 01.01 Motor speed used.	-
	0.00... 30000.00 rpm		1 = 1 rpm
01.62	<i>Abs motor speed %</i>	Absolute value of the motor speed % 01.03 Motor speed %	-
	0.00... 1000.00%		10 = 1%
01.63	<i>Abs output frequency</i>	Absolute value of the output frequency 01.06 Output frequency	-
	0.00...500.00 Hz		1 = 1 Hz
01.64	<i>Abs motor torque</i>	Absolute value of the motor torque 01.10 Motor torque.	-
	0.0...1600.0%		1 = 1%
01.65	<i>Abs output power</i>	Absolute value of the output power 01.14 Output power.	-
	0.00...32767.00 kW		1 = 1 kW
01.66	<i>Abs output power % motor nom</i>	Absolute value of the output power % of motor nominal 01.15 Output power % of motor nom.	-
	0.00... 300.00%		1 = 1%
01.68	<i>Abs motor shaft power</i>	Absolute value of the motor shaft power 01.17 Motor shaft power.	-
	0.00...332767.00 kW		1 = 1 kW
<i>03 Input references</i>		Values of references received from various sources. All parameters in this group are read-only unless otherwise noted.	
03.01	<i>Panel reference</i>	Local mode reference is given from the control panel.	0
	-100000.00... 100000.00 rpm, Hz or %	Control panel or PC tool reference.	1 = 10 unit
03.02	<i>Panel reference remote</i>	Remote mode reference given from the control panel.	-
	-100000.00... 100000.00 rpm, Hz or %	Control panel or PC tool reference.	1 = 10 unit
03.09	<i>EFB reference 1</i>	Scaled reference 1 received through the embedded fieldbus interface. The scaling is defined by 58.26 EFB ref1 type	-
	-30000.00 ... 30000.00	Scaled reference 1 received through the embedded fieldbus interface.	1 = 10

No.	Name/Value	Description	Default FbEq 16
03.10	<i>EFB reference 2</i>	Scaled embedded fieldbus reference 2.	-
	-30000.00 ... 30000.00	Scaled reference 2 received through the embedded fieldbus interface. The scaling is defined by <i>58.27 EFB ref2 type</i>	1 = 10
03.17	<i>Integrated Panel ref</i>	Local mode reference given from the integrated control panel. The unit (rpm, Hz or %) is set from parameter.	0
	-100000.00 ... 100000.00 rpm, Hz or %	Integrated control panel reference.	1 = 10
03.18	<i>Integrated Panel ref remote</i>	Remote mode reference given from the integrated control panel.	0
	-100000.00 ... 100000.00 rpm, Hz or %	Integrated control panel reference.	1 = 10
<i>04 Warnings and faults</i>		Information on warnings and faults that occurred last. For explanations of individual warning and fault codes, see chapter <i>Fault tracing</i> . All parameters in this group are read-only unless otherwise noted.	
04.01	<i>Tripping fault</i>	Code of the 1st active fault (the fault that caused the drive to trip as it arrived at the trip register).	-
	0000h...FFFFh	Fault code.	1=1
04.02	<i>Active fault 2</i>	2nd active fault in the trip register.	-
	0000h...FFFFh	Fault code.	1=1
04.03	<i>Active fault 3</i>	3rd active fault in the trip register.	-
	0000h...FFFFh	Fault code.	1=1
04.06	<i>Active warning 1</i>	1st active warning in warning register.	-
	0000h...FFFFh	Warning code.	1=1
04.07	<i>Active warning 2</i>	2nd active warning in warning register.	-
	0000h...FFFFh	Warning code.	1=1
04.08	<i>Active warning 3</i>	3rd active warning in warning register.	-
	0000h...FFFFh	Warning code.	1=1
04.11	<i>Latest fault</i>	Latest fault in the trip log store. The trip log store is loaded with the active faults in the order they occur.	-
	0000h...FFFFh	Fault code.	1=1
04.12	<i>2nd latest fault</i>	2nd fault in trip log store.	-
	0000h...FFFFh	Fault code.	1=1
04.13	<i>3rd latest fault</i>	3rd fault in trip log store.	-
	0000h...FFFFh	Fault code.	1=1
04.16	<i>Latest warning</i>	Latest warning in the warning log store. The warning log store is loaded with the active warnings in the order they occur.	-
	0000h...FFFFh	Warning code.	1=1

116 Parameters

No.	Name/Value	Description	Default FbEq 16															
04.17	2nd latest warning	2nd warning in trip log store.	-															
	0000h...FFFFh	Warning code.	1=1															
04.18	3rd latest warning	3rd warning in trip log store.	-															
	0000h...FFFFh	Warning code.	1=1															
04.40	Event word 1	Shows the user-defined event word. This word collects the status of the events (warnings, faults or pure events) selected by parameters 04.41...04.71. This parameter is read-only.	-															
<table border="1"> <thead> <tr> <th>Bit</th> <th>Name</th> <th>Description</th> </tr> </thead> <tbody> <tr> <td>0</td> <td>User bit 0</td> <td>1 = Event selected by parameter 04.41 is active.</td> </tr> <tr> <td>1</td> <td>User bit 1</td> <td>1 = Event selected by parameter 04.43 is active.</td> </tr> <tr> <td>...</td> <td>...</td> <td>...</td> </tr> <tr> <td>15</td> <td>User bit 15</td> <td>1 = Event selected by parameter 04.71 is active.</td> </tr> </tbody> </table>				Bit	Name	Description	0	User bit 0	1 = Event selected by parameter 04.41 is active.	1	User bit 1	1 = Event selected by parameter 04.43 is active.	15	User bit 15	1 = Event selected by parameter 04.71 is active.
Bit	Name	Description																
0	User bit 0	1 = Event selected by parameter 04.41 is active.																
1	User bit 1	1 = Event selected by parameter 04.43 is active.																
...																
15	User bit 15	1 = Event selected by parameter 04.71 is active.																
	0000h...FFFFh		1 = 1															
04.41	Event word 1 bit 0 code	Selects the hexadecimal code of an event (warning, fault or pure event) whose status is shown as bit 0 of parameter 04.40. See chapter <i>Fault tracing</i> (page 353) for the event codes.	0X2310h															
	0000h...FFFFh	Code of event.	1 = 1															
04.43	Event word 1 bit 1 code	Selects the hexadecimal code of an event (warning, fault or pure event) whose status is shown as bit 1 of parameter 04.40. See chapter <i>Fault tracing</i> (page 353) for the event codes.	0X3210h															
	0000h...FFFFh	Code of event.	1 = 1															
04.45	Event word 1 bit 2 code	...	0X4310h															
04.47	Event word 1 bit 3 code	...	0X2340h															
04.49	Event word 1 bit 4 code	...	0X0000h															
04.51	Event word 1 bit 5 code	...	0X3220h															
04.53	Event word 1 bit 6 code	...	0X80A0h															
04.55	Event word 1 bit 7 code	...	0X0000h															
04.57	Event word 1 bit 8 code	...	0X7122h															
04.59	Event word 1 bit 9 code	...	0X7081h															
04.61	Event word 1 bit 10 code	...	0XFF61h															
04.63	Event word 1 bit 11 code	...	0X7121h															
04.65	Event word 1 bit 12 code	...	0X4110h															

No.	Name/Value	Description	Default FbEq 16
04.67	Event word 1 bit 13 code	...	0X9081h
04.69	Event word 1 bit 14 code	...	0X9082h
04.71	Event word 1 bit 15 code	Selects the hexadecimal code of an event (warning, fault or pure event) whose status is shown as bit 15 of parameter 04.40. See chapter <i>Fault tracing</i> (page 353) for the event codes.	0X2330h
	0000h...FFFFh	Code of event.	1 = 1
05 Diagnostics		Various run-time-type counters and measurements related to drive maintenance. All parameters in this group are read-only unless otherwise noted.	
05.01	On-time counter	Drive on-time counter. The counter runs when the drive is powered.	-
	0...65535 d	On-time counter (number of days).	1 = 1 d
05.02	Run-time counter	Motor run-time counter. The counter runs when the inverter modulates.	-
	0...65535 d	Motor run-time counter.	1 = 1 d
05.03	Hours run	Corresponding parameter to 05.02 <i>Run-time counter</i> in hours, that is, $24 * 05.02$ value + fractional part of a day.	-
	0... 429496729.5 h	Hours.	1 = 1 h
05.04	Fan on-time counter	Running time of the drive cooling fan. Can be reset from the control panel by keeping Reset down for over 3 seconds.	-
	0...65535 d	Cooling fan run-time.	1 = 1 d
05.10	Control board temperature	Measured temperature of the control board.	-
	-100... 300 °C or °F	Temperature in degrees Celsius for Fahrenheit.	1 = unit
05.11	Inverter temperature	Estimated drive temperature in percent of fault limit. The fault limit varies according to the type of the drive. 0.0% = 0 °C (32 °F) 100.0% = Fault limit	-
	-40.0...160.0%	Temperature in percent.	1 = 1%

118 Parameters

No.	Name/Value	Description	Default FbEq 16																																				
05.20	<i>Diagnostic word 1</i>	Diagnostic word 1. For possible causes and remedies, see chapter <i>Fault tracing</i> .	0b0000																																				
<table border="1"> <thead> <tr> <th>Bit</th> <th>Name</th> <th>Value</th> </tr> </thead> <tbody> <tr> <td>0</td> <td>Any warning or fault</td> <td>Yes = Drive has generated a warning or tripped on a fault.</td> </tr> <tr> <td>1</td> <td>Any warning</td> <td>Yes = Drive has generated a warning.</td> </tr> <tr> <td>2</td> <td>Any fault</td> <td>Yes = Drive has tripped on a fault.</td> </tr> <tr> <td>3</td> <td>Reserved</td> <td></td> </tr> <tr> <td>4</td> <td>Overcurrent fault</td> <td>Yes = Drive has tripped on fault <i>2310 Overcurrent</i>.</td> </tr> <tr> <td>5</td> <td>Reserved</td> <td></td> </tr> <tr> <td>6</td> <td>DC overvoltage</td> <td>Yes = Drive has tripped on fault <i>3210 DC link overvoltage</i>.</td> </tr> <tr> <td>7</td> <td>DC undervoltage</td> <td>Yes = Drive has tripped on fault <i>3220 DC link undervoltage</i>.</td> </tr> <tr> <td>8</td> <td>Reserved</td> <td></td> </tr> <tr> <td>9</td> <td>Device overtemp flt</td> <td>Yes = Drive has tripped on fault <i>4310 Excess temperature</i>.</td> </tr> <tr> <td>10...15</td> <td>Reserved</td> <td></td> </tr> </tbody> </table>				Bit	Name	Value	0	Any warning or fault	Yes = Drive has generated a warning or tripped on a fault.	1	Any warning	Yes = Drive has generated a warning.	2	Any fault	Yes = Drive has tripped on a fault.	3	Reserved		4	Overcurrent fault	Yes = Drive has tripped on fault <i>2310 Overcurrent</i> .	5	Reserved		6	DC overvoltage	Yes = Drive has tripped on fault <i>3210 DC link overvoltage</i> .	7	DC undervoltage	Yes = Drive has tripped on fault <i>3220 DC link undervoltage</i> .	8	Reserved		9	Device overtemp flt	Yes = Drive has tripped on fault <i>4310 Excess temperature</i> .	10...15	Reserved	
Bit	Name	Value																																					
0	Any warning or fault	Yes = Drive has generated a warning or tripped on a fault.																																					
1	Any warning	Yes = Drive has generated a warning.																																					
2	Any fault	Yes = Drive has tripped on a fault.																																					
3	Reserved																																						
4	Overcurrent fault	Yes = Drive has tripped on fault <i>2310 Overcurrent</i> .																																					
5	Reserved																																						
6	DC overvoltage	Yes = Drive has tripped on fault <i>3210 DC link overvoltage</i> .																																					
7	DC undervoltage	Yes = Drive has tripped on fault <i>3220 DC link undervoltage</i> .																																					
8	Reserved																																						
9	Device overtemp flt	Yes = Drive has tripped on fault <i>4310 Excess temperature</i> .																																					
10...15	Reserved																																						
0b0000...0b1111		Diagnostic word 1.	1 = 1																																				
05.21	<i>Diagnostic word 2</i>	Diagnostic word 2. For possible causes and remedies, see chapter <i>Fault tracing</i> .	0b0000																																				
<table border="1"> <thead> <tr> <th>Bit</th> <th>Name</th> <th>Value</th> </tr> </thead> <tbody> <tr> <td>0...9</td> <td>Reserved</td> <td></td> </tr> <tr> <td>10</td> <td>Motor overtemp flt</td> <td>Yes = Drive has tripped on fault <i>4981 External temperature 1</i>.</td> </tr> <tr> <td>11...15</td> <td>Reserved</td> <td></td> </tr> </tbody> </table>				Bit	Name	Value	0...9	Reserved		10	Motor overtemp flt	Yes = Drive has tripped on fault <i>4981 External temperature 1</i> .	11...15	Reserved																									
Bit	Name	Value																																					
0...9	Reserved																																						
10	Motor overtemp flt	Yes = Drive has tripped on fault <i>4981 External temperature 1</i> .																																					
11...15	Reserved																																						
0b0000...0b1111		Diagnostic word 2.	1 = 1																																				
05.22	<i>Diagnostic word 3</i>	Diagnostic word 3. For possible causes and remedies, see chapter <i>Fault tracing</i> .	0b0000																																				
<table border="1"> <thead> <tr> <th>Bit</th> <th>Name</th> <th>Value</th> </tr> </thead> <tbody> <tr> <td>0...8</td> <td>Reserved</td> <td></td> </tr> <tr> <td>9</td> <td>kWh pulse</td> <td>1 = kWh pulse is active.</td> </tr> <tr> <td>10</td> <td>Reserved</td> <td></td> </tr> <tr> <td>11</td> <td>Fan command</td> <td>1 = Drive fan is rotating above idle speed.</td> </tr> <tr> <td>12...15</td> <td>Reserved</td> <td></td> </tr> </tbody> </table>				Bit	Name	Value	0...8	Reserved		9	kWh pulse	1 = kWh pulse is active.	10	Reserved		11	Fan command	1 = Drive fan is rotating above idle speed.	12...15	Reserved																			
Bit	Name	Value																																					
0...8	Reserved																																						
9	kWh pulse	1 = kWh pulse is active.																																					
10	Reserved																																						
11	Fan command	1 = Drive fan is rotating above idle speed.																																					
12...15	Reserved																																						
0b0000...0b1111		Diagnostic word 3.	1 = 1																																				
05.80	<i>Motor speed at fault</i>	Displays the motor speed (<i>01.01</i>) at which fault occurred.	-																																				
-30000.00... 30000.00 rpm		Motor speed at fault.	See par. <i>46.01</i>																																				
05.81	<i>Output frequency at fault</i>	Displays the output frequency (<i>01.06</i>) at which fault occurred.	-																																				
-500.00...500.00 Hz		Output frequency at fault.	See par. <i>46.02</i>																																				

No.	Name/Value	Description	Default FbEq 16																																		
05.82	DC voltage at fault	Displays the DC link volt age (01.11) at which fault occurred.	-																																		
	0.00...2000.00 V	DC voltage at fault.	10 = 1 V																																		
05.83	Motor current at fault	Displays the motor current (01.07) at which fault occurred.	-																																		
	0.00...30000.00 A	Motor current at fault.	See par. 46.05																																		
05.84	Motor torque at fault	Displays the motor torque (01.10) at which fault occurred	-																																		
	-1600.0...1600.0%	Motor torque at fault.	See par. 46.03																																		
05.85	Main status word at fault	Displays the main status word (06.11) at which fault occurred. For the bit list, see parameter 06.11 Main status word.	0000h																																		
		<table border="1"> <thead> <tr> <th>Bit</th> <th>Name</th> </tr> </thead> <tbody> <tr><td>0</td><td>Ready to switch ON</td></tr> <tr><td>1</td><td>Ready run</td></tr> <tr><td>2</td><td>Ready ref</td></tr> <tr><td>3</td><td>Tripped</td></tr> <tr><td>4</td><td>Not in use</td></tr> <tr><td>5</td><td>Not in use</td></tr> <tr><td>6</td><td>Not in use</td></tr> <tr><td>7</td><td>Warning</td></tr> <tr><td>8</td><td>Modulating</td></tr> <tr><td>9</td><td>Remote</td></tr> <tr><td>10</td><td>Net OK</td></tr> <tr><td>11</td><td>User bit 0</td></tr> <tr><td>12</td><td>User bit 1</td></tr> <tr><td>13</td><td>User bit 2</td></tr> <tr><td>14</td><td>Charging</td></tr> <tr><td>15</td><td>User bit 3</td></tr> </tbody> </table>	Bit	Name	0	Ready to switch ON	1	Ready run	2	Ready ref	3	Tripped	4	Not in use	5	Not in use	6	Not in use	7	Warning	8	Modulating	9	Remote	10	Net OK	11	User bit 0	12	User bit 1	13	User bit 2	14	Charging	15	User bit 3	
Bit	Name																																				
0	Ready to switch ON																																				
1	Ready run																																				
2	Ready ref																																				
3	Tripped																																				
4	Not in use																																				
5	Not in use																																				
6	Not in use																																				
7	Warning																																				
8	Modulating																																				
9	Remote																																				
10	Net OK																																				
11	User bit 0																																				
12	User bit 1																																				
13	User bit 2																																				
14	Charging																																				
15	User bit 3																																				
	0000h...FFFFh	Main status word at fault.	1 = 1																																		
05.86	DI delayed status at fault	Displays the DI delayed status (10.02) at which fault occurred. For the bit list, see parameter 10.02 DI delayed status.	0000h																																		
	0000h...FFFFh	DI delayed status at fault.	1 = 1																																		
05.87	Inverter temperature at fault	Displays the inverter temperature (05.11) at which fault occurred.	-																																		
	-40...160°C	Inverter temperature at fault.	1 = 1°C																																		
05.88	Reference used at fault	Displays the reference used (28.01/26.73/23.01) at which fault occurred. The type of the reference depends on the selected operation mode (19.01).	-																																		
	-500.00...500.00 Hz/ -1600.0...1600.0%/ 30000.00... 30000.00 rpm	Reference used at fault.	See par. 46.02/ See par. 46.03/ See par. 46.01																																		

120 Parameters

No.	Name/Value	Description	Default FbEq 16																																		
<i>06 Control and status words</i>		Drive control and status words.																																			
06.01	<i>Main control word</i>	<p>The main control word of the drive. This parameter shows the control signals as received from the selected sources (such as digital inputs, the fieldbus interfaces and the application program).</p> <p>The bit assignments of the word are as described on page 387. The related status word are presented on pages 387.</p> <p>This parameter is read-only.</p> <p>Note: With the fieldbus control, the parameter value is not same as the value that it receives from the PLC.</p> <table border="1" data-bbox="367 496 729 884"> <thead> <tr> <th>Bit</th> <th>Name</th> </tr> </thead> <tbody> <tr><td>0</td><td>OFF1_CONTROL</td></tr> <tr><td>1</td><td>OFF2_CONTROL</td></tr> <tr><td>2</td><td>OFF3_CONTROL</td></tr> <tr><td>3</td><td>INHIBIT_OPERATION</td></tr> <tr><td>4</td><td>RAMP_OUT_ZERO</td></tr> <tr><td>5</td><td>RAMP_HOLD</td></tr> <tr><td>6</td><td>RAMP_IN_ZERO</td></tr> <tr><td>7</td><td>RESET</td></tr> <tr><td>8</td><td>JOGGING_1</td></tr> <tr><td>9</td><td>JOGGING_2</td></tr> <tr><td>10</td><td>REMOTE_CMD</td></tr> <tr><td>11</td><td>EXT_CTRL_LOC</td></tr> <tr><td>12</td><td>USER_0</td></tr> <tr><td>13</td><td>USER_1</td></tr> <tr><td>14</td><td>USER_2</td></tr> <tr><td>15</td><td>USER_3</td></tr> </tbody> </table>	Bit	Name	0	OFF1_CONTROL	1	OFF2_CONTROL	2	OFF3_CONTROL	3	INHIBIT_OPERATION	4	RAMP_OUT_ZERO	5	RAMP_HOLD	6	RAMP_IN_ZERO	7	RESET	8	JOGGING_1	9	JOGGING_2	10	REMOTE_CMD	11	EXT_CTRL_LOC	12	USER_0	13	USER_1	14	USER_2	15	USER_3	0000h
Bit	Name																																				
0	OFF1_CONTROL																																				
1	OFF2_CONTROL																																				
2	OFF3_CONTROL																																				
3	INHIBIT_OPERATION																																				
4	RAMP_OUT_ZERO																																				
5	RAMP_HOLD																																				
6	RAMP_IN_ZERO																																				
7	RESET																																				
8	JOGGING_1																																				
9	JOGGING_2																																				
10	REMOTE_CMD																																				
11	EXT_CTRL_LOC																																				
12	USER_0																																				
13	USER_1																																				
14	USER_2																																				
15	USER_3																																				
0000h...FFFFh	Main control word.		1 = 1																																		

No.	Name/Value	Description	Default FbEq 16																																		
06.11	<i>Main status word</i>	<p>ABB Drives Profile Main status word. Reflects the status of the drive irrespective of control source e.g. a fieldbus system, control panel (keypad), PC-Tool, standard I/O, application program or sequence programming, and irrespective of the actual control profile which is used to control the drive.</p> <p>The bit assignments are described on page 390 (Contents of the fieldbus control word). The state diagram (valid for ABB drives profile) is on page 393. This parameter is read-only.</p> <p>Note: With the fieldbus control, the parameter value is not same as the value that it receives from the PLC.</p> <table border="1" data-bbox="423 499 692 887"> <thead> <tr> <th>Bit</th> <th>Name</th> </tr> </thead> <tbody> <tr><td>0</td><td><i>RDY_ON</i></td></tr> <tr><td>1</td><td><i>RDY_RUN</i></td></tr> <tr><td>2</td><td><i>RDY_REF</i></td></tr> <tr><td>3</td><td><i>TRIPPED</i></td></tr> <tr><td>4</td><td><i>OFF_2_STATUS</i></td></tr> <tr><td>5</td><td><i>OFF_3_STATUS</i></td></tr> <tr><td>6</td><td><i>SWC_ON_INHIB</i></td></tr> <tr><td>7</td><td><i>ALARM</i></td></tr> <tr><td>8</td><td><i>AT_SETPOINT</i></td></tr> <tr><td>9</td><td><i>REMOTE</i></td></tr> <tr><td>10</td><td><i>ABOVE_LIMIT</i></td></tr> <tr><td>11</td><td><i>USER_0</i></td></tr> <tr><td>12</td><td><i>USER_1</i></td></tr> <tr><td>13</td><td><i>USER_2</i></td></tr> <tr><td>14</td><td><i>USER_3</i></td></tr> <tr><td>15</td><td><i>Reserved</i></td></tr> </tbody> </table>	Bit	Name	0	<i>RDY_ON</i>	1	<i>RDY_RUN</i>	2	<i>RDY_REF</i>	3	<i>TRIPPED</i>	4	<i>OFF_2_STATUS</i>	5	<i>OFF_3_STATUS</i>	6	<i>SWC_ON_INHIB</i>	7	<i>ALARM</i>	8	<i>AT_SETPOINT</i>	9	<i>REMOTE</i>	10	<i>ABOVE_LIMIT</i>	11	<i>USER_0</i>	12	<i>USER_1</i>	13	<i>USER_2</i>	14	<i>USER_3</i>	15	<i>Reserved</i>	0000h
Bit	Name																																				
0	<i>RDY_ON</i>																																				
1	<i>RDY_RUN</i>																																				
2	<i>RDY_REF</i>																																				
3	<i>TRIPPED</i>																																				
4	<i>OFF_2_STATUS</i>																																				
5	<i>OFF_3_STATUS</i>																																				
6	<i>SWC_ON_INHIB</i>																																				
7	<i>ALARM</i>																																				
8	<i>AT_SETPOINT</i>																																				
9	<i>REMOTE</i>																																				
10	<i>ABOVE_LIMIT</i>																																				
11	<i>USER_0</i>																																				
12	<i>USER_1</i>																																				
13	<i>USER_2</i>																																				
14	<i>USER_3</i>																																				
15	<i>Reserved</i>																																				
0000h...FFFFh	Main status word.	1 = 1																																			

122 Parameters

No.	Name/Value	Description	Default FbEq 16																																																
06.16	Drive status word 1	Drive status word 1. This parameter is read-only.	-																																																
<table border="1"> <thead> <tr> <th>Bit</th> <th>Name</th> <th>Description</th> </tr> </thead> <tbody> <tr> <td>0</td> <td>Enabled</td> <td>1 = Both run enable (see par. 20.12) and start enable (20.19) signals are present. Note: This bit is not affected by the presence of a fault.</td> </tr> <tr> <td>1</td> <td>Inhibited</td> <td>1 = Start inhibited. To start the drive, the inhibiting signal (see par. 06.18) must be removed and the start signal cycled.</td> </tr> <tr> <td>2</td> <td>DC charged</td> <td>1 = DC circuit has been charged</td> </tr> <tr> <td>3</td> <td>Ready to start</td> <td>1 = Drive is ready to receive a start command</td> </tr> <tr> <td>4</td> <td>Following reference</td> <td>1 = Drive is ready to follow given reference</td> </tr> <tr> <td>5</td> <td>Started</td> <td>1 = Drive has been started</td> </tr> <tr> <td>6</td> <td>Modulating</td> <td>1 = Drive is modulating (output stage is being controlled)</td> </tr> <tr> <td>7</td> <td>Limiting</td> <td>1 = Any operating limit (speed, torque, etc.) is active</td> </tr> <tr> <td>8</td> <td>Local control</td> <td>1 = Drive is in local control</td> </tr> <tr> <td>10</td> <td>Ext1 active</td> <td>1 = Control location EXT1 active</td> </tr> <tr> <td>11</td> <td>Ext2 active</td> <td>1 = Control location EXT2 active</td> </tr> <tr> <td>12</td> <td>Reserved</td> <td></td> </tr> <tr> <td>13</td> <td>Start request</td> <td>1 = Start requested. 0 = When Enable to rotate signal (see par. 20.22) is 0 (rotating of the motor is disabled).</td> </tr> <tr> <td>14</td> <td>Running</td> <td>1 = Drive is running</td> </tr> <tr> <td>15</td> <td>Reserved</td> <td></td> </tr> </tbody> </table>				Bit	Name	Description	0	Enabled	1 = Both run enable (see par. 20.12) and start enable (20.19) signals are present. Note: This bit is not affected by the presence of a fault.	1	Inhibited	1 = Start inhibited. To start the drive, the inhibiting signal (see par. 06.18) must be removed and the start signal cycled.	2	DC charged	1 = DC circuit has been charged	3	Ready to start	1 = Drive is ready to receive a start command	4	Following reference	1 = Drive is ready to follow given reference	5	Started	1 = Drive has been started	6	Modulating	1 = Drive is modulating (output stage is being controlled)	7	Limiting	1 = Any operating limit (speed, torque, etc.) is active	8	Local control	1 = Drive is in local control	10	Ext1 active	1 = Control location EXT1 active	11	Ext2 active	1 = Control location EXT2 active	12	Reserved		13	Start request	1 = Start requested. 0 = When Enable to rotate signal (see par. 20.22) is 0 (rotating of the motor is disabled).	14	Running	1 = Drive is running	15	Reserved	
Bit	Name	Description																																																	
0	Enabled	1 = Both run enable (see par. 20.12) and start enable (20.19) signals are present. Note: This bit is not affected by the presence of a fault.																																																	
1	Inhibited	1 = Start inhibited. To start the drive, the inhibiting signal (see par. 06.18) must be removed and the start signal cycled.																																																	
2	DC charged	1 = DC circuit has been charged																																																	
3	Ready to start	1 = Drive is ready to receive a start command																																																	
4	Following reference	1 = Drive is ready to follow given reference																																																	
5	Started	1 = Drive has been started																																																	
6	Modulating	1 = Drive is modulating (output stage is being controlled)																																																	
7	Limiting	1 = Any operating limit (speed, torque, etc.) is active																																																	
8	Local control	1 = Drive is in local control																																																	
10	Ext1 active	1 = Control location EXT1 active																																																	
11	Ext2 active	1 = Control location EXT2 active																																																	
12	Reserved																																																		
13	Start request	1 = Start requested. 0 = When Enable to rotate signal (see par. 20.22) is 0 (rotating of the motor is disabled).																																																	
14	Running	1 = Drive is running																																																	
15	Reserved																																																		
0000h...FFFFh		Drive status word 1.	1 = 1																																																

No.	Name/Value	Description	Default FbEq 16																																													
06.17	Drive status word 2	Drive status word 2. This parameter is read-only.	-																																													
<table border="1"> <thead> <tr> <th>Bit</th> <th>Name</th> <th>Description</th> </tr> </thead> <tbody> <tr> <td>0</td> <td>Identification run done</td> <td>1 = Motor identification (ID) run has been performed</td> </tr> <tr> <td>1</td> <td>Magnetized</td> <td>1 = The motor has been magnetized</td> </tr> <tr> <td>2</td> <td>Torque control</td> <td>1 = Torque control mode active</td> </tr> <tr> <td>3</td> <td>Speed control</td> <td>1 = Speed control mode active</td> </tr> <tr> <td>4</td> <td>Reserved</td> <td></td> </tr> <tr> <td>5</td> <td>Safe reference active</td> <td>1 = A "safe" reference is applied by functions such as parameters <i>49.05</i></td> </tr> <tr> <td>6</td> <td>Last speed active</td> <td>1 = A "last speed" reference is applied by functions such as parameters <i>49.05</i></td> </tr> <tr> <td>7</td> <td>Reserved</td> <td></td> </tr> <tr> <td>8</td> <td>Emergency stop failed</td> <td>1 = Emergency stop failed (see parameters <i>31.32</i> and <i>31.33</i>)</td> </tr> <tr> <td>9</td> <td>Jogging active</td> <td>1 = Jogging enable signal is on</td> </tr> <tr> <td>10</td> <td>Above limit</td> <td>Actual speed, frequency or torque equals or exceeds the limit (defined by parameters 46.31...45.33). Valid for both directions of rotation.</td> </tr> <tr> <td>11...12</td> <td>Reserved</td> <td></td> </tr> <tr> <td>13</td> <td>Start delay active</td> <td>1 = Start delay (par. <i>21.22</i>) active.</td> </tr> <tr> <td>14...15</td> <td>Reserved</td> <td></td> </tr> </tbody> </table>				Bit	Name	Description	0	Identification run done	1 = Motor identification (ID) run has been performed	1	Magnetized	1 = The motor has been magnetized	2	Torque control	1 = Torque control mode active	3	Speed control	1 = Speed control mode active	4	Reserved		5	Safe reference active	1 = A "safe" reference is applied by functions such as parameters <i>49.05</i>	6	Last speed active	1 = A "last speed" reference is applied by functions such as parameters <i>49.05</i>	7	Reserved		8	Emergency stop failed	1 = Emergency stop failed (see parameters <i>31.32</i> and <i>31.33</i>)	9	Jogging active	1 = Jogging enable signal is on	10	Above limit	Actual speed, frequency or torque equals or exceeds the limit (defined by parameters 46.31...45.33). Valid for both directions of rotation.	11...12	Reserved		13	Start delay active	1 = Start delay (par. <i>21.22</i>) active.	14...15	Reserved	
Bit	Name	Description																																														
0	Identification run done	1 = Motor identification (ID) run has been performed																																														
1	Magnetized	1 = The motor has been magnetized																																														
2	Torque control	1 = Torque control mode active																																														
3	Speed control	1 = Speed control mode active																																														
4	Reserved																																															
5	Safe reference active	1 = A "safe" reference is applied by functions such as parameters <i>49.05</i>																																														
6	Last speed active	1 = A "last speed" reference is applied by functions such as parameters <i>49.05</i>																																														
7	Reserved																																															
8	Emergency stop failed	1 = Emergency stop failed (see parameters <i>31.32</i> and <i>31.33</i>)																																														
9	Jogging active	1 = Jogging enable signal is on																																														
10	Above limit	Actual speed, frequency or torque equals or exceeds the limit (defined by parameters 46.31...45.33). Valid for both directions of rotation.																																														
11...12	Reserved																																															
13	Start delay active	1 = Start delay (par. <i>21.22</i>) active.																																														
14...15	Reserved																																															
0000h...FFFFh		Drive status word 2.	1 = 1																																													

No.	Name/Value	Description	Default FbEq 16																																																			
06.18	<i>Start inhibit status word</i>	<p>Start inhibit status word. This word specifies the source of the inhibiting signal that is preventing the drive from starting.</p> <p>The conditions marked with an asterisk (*) only require that the start command is cycled to reset the inhibition. In all other instances, the inhibiting condition must be removed first.</p> <p>See also parameter <i>06.16 Drive status word 1</i>, bit 1.</p> <p>This parameter is read-only.</p>	-																																																			
<table border="1"> <thead> <tr> <th>Bit</th> <th>Name</th> <th>Description</th> </tr> </thead> <tbody> <tr> <td>0</td> <td>Not ready run</td> <td>1 = DC voltage is missing or drive has not been parametrized correctly. Check the parameters in groups 95 and 99.</td> </tr> <tr> <td>1</td> <td>Ctrl location changed</td> <td>* 1 = Control location has changed</td> </tr> <tr> <td>2</td> <td>SSW inhibit</td> <td>1 = Control program is keeping itself in inhibited state</td> </tr> <tr> <td>3</td> <td>Fault reset</td> <td>* 1 = A fault has been reset</td> </tr> <tr> <td>4</td> <td>Lost start enable</td> <td>1 = Start enable signal missing</td> </tr> <tr> <td>5</td> <td>Lost run enable</td> <td>1 = Run enable signal missing</td> </tr> <tr> <td>6</td> <td>Reserved</td> <td></td> </tr> <tr> <td>7</td> <td>STO</td> <td>1 = Safe torque off function active</td> </tr> <tr> <td>8</td> <td>Current calibration ended</td> <td>* 1 = Current calibration routine has finished</td> </tr> <tr> <td>9</td> <td>ID run ended</td> <td>* 1 = Motor identification run has finished</td> </tr> <tr> <td>10</td> <td>Reserved</td> <td>-</td> </tr> <tr> <td>11</td> <td>Em Off1</td> <td>1 = Emergency stop signal (mode off1)</td> </tr> <tr> <td>12</td> <td>Em Off2</td> <td>1 = Emergency stop signal (mode off2)</td> </tr> <tr> <td>13</td> <td>Em Off3</td> <td>1 = Emergency stop signal (mode off3)</td> </tr> <tr> <td>14</td> <td>Auto reset inhibit</td> <td>1 = The autoreset function is inhibiting operation</td> </tr> <tr> <td>15</td> <td>Jogging active</td> <td>1 = The jogging enable signal is inhibiting operation</td> </tr> </tbody> </table>				Bit	Name	Description	0	Not ready run	1 = DC voltage is missing or drive has not been parametrized correctly. Check the parameters in groups 95 and 99.	1	Ctrl location changed	* 1 = Control location has changed	2	SSW inhibit	1 = Control program is keeping itself in inhibited state	3	Fault reset	* 1 = A fault has been reset	4	Lost start enable	1 = Start enable signal missing	5	Lost run enable	1 = Run enable signal missing	6	Reserved		7	STO	1 = Safe torque off function active	8	Current calibration ended	* 1 = Current calibration routine has finished	9	ID run ended	* 1 = Motor identification run has finished	10	Reserved	-	11	Em Off1	1 = Emergency stop signal (mode off1)	12	Em Off2	1 = Emergency stop signal (mode off2)	13	Em Off3	1 = Emergency stop signal (mode off3)	14	Auto reset inhibit	1 = The autoreset function is inhibiting operation	15	Jogging active	1 = The jogging enable signal is inhibiting operation
Bit	Name	Description																																																				
0	Not ready run	1 = DC voltage is missing or drive has not been parametrized correctly. Check the parameters in groups 95 and 99.																																																				
1	Ctrl location changed	* 1 = Control location has changed																																																				
2	SSW inhibit	1 = Control program is keeping itself in inhibited state																																																				
3	Fault reset	* 1 = A fault has been reset																																																				
4	Lost start enable	1 = Start enable signal missing																																																				
5	Lost run enable	1 = Run enable signal missing																																																				
6	Reserved																																																					
7	STO	1 = Safe torque off function active																																																				
8	Current calibration ended	* 1 = Current calibration routine has finished																																																				
9	ID run ended	* 1 = Motor identification run has finished																																																				
10	Reserved	-																																																				
11	Em Off1	1 = Emergency stop signal (mode off1)																																																				
12	Em Off2	1 = Emergency stop signal (mode off2)																																																				
13	Em Off3	1 = Emergency stop signal (mode off3)																																																				
14	Auto reset inhibit	1 = The autoreset function is inhibiting operation																																																				
15	Jogging active	1 = The jogging enable signal is inhibiting operation																																																				
0000h...FFFFh		Start inhibit status word.	1 = 1																																																			
06.19	<i>Speed control status word</i>	<p>Speed control status word.</p> <p>This parameter is read-only.</p>	--																																																			
<table border="1"> <thead> <tr> <th>Bit</th> <th>Name</th> <th>Description</th> </tr> </thead> <tbody> <tr> <td>0</td> <td>Zero speed</td> <td>1 = Drive has been running below zero speed limit (par. <i>21.06</i>) for a time defined by parameter <i>21.07 Zero speed delay</i></td> </tr> <tr> <td>1</td> <td>Forward</td> <td>1 = Drive is running in forward direction above zero speed limit (par. <i>21.06</i>)</td> </tr> <tr> <td>2</td> <td>Reverse</td> <td>1 = Drive is running in reverse direction above zero speed limit (par. <i>21.06</i>)</td> </tr> <tr> <td>3</td> <td>Out of window</td> <td>Speed out of speed window</td> </tr> <tr> <td>4</td> <td>Internal speed feedback</td> <td>Estimate used for motor control</td> </tr> <tr> <td>7</td> <td>Any constant speed request</td> <td>1 = A constant speed or frequency has been selected; see par. <i>06.20</i> below.</td> </tr> <tr> <td>10...15</td> <td>Reserved</td> <td></td> </tr> </tbody> </table>				Bit	Name	Description	0	Zero speed	1 = Drive has been running below zero speed limit (par. <i>21.06</i>) for a time defined by parameter <i>21.07 Zero speed delay</i>	1	Forward	1 = Drive is running in forward direction above zero speed limit (par. <i>21.06</i>)	2	Reverse	1 = Drive is running in reverse direction above zero speed limit (par. <i>21.06</i>)	3	Out of window	Speed out of speed window	4	Internal speed feedback	Estimate used for motor control	7	Any constant speed request	1 = A constant speed or frequency has been selected; see par. <i>06.20</i> below.	10...15	Reserved																												
Bit	Name	Description																																																				
0	Zero speed	1 = Drive has been running below zero speed limit (par. <i>21.06</i>) for a time defined by parameter <i>21.07 Zero speed delay</i>																																																				
1	Forward	1 = Drive is running in forward direction above zero speed limit (par. <i>21.06</i>)																																																				
2	Reverse	1 = Drive is running in reverse direction above zero speed limit (par. <i>21.06</i>)																																																				
3	Out of window	Speed out of speed window																																																				
4	Internal speed feedback	Estimate used for motor control																																																				
7	Any constant speed request	1 = A constant speed or frequency has been selected; see par. <i>06.20</i> below.																																																				
10...15	Reserved																																																					
0000h...FFFFh		Speed control status word.	1 = 1																																																			

No.	Name/Value	Description	Default FbEq 16																											
06.20	<i>Constant speed status word</i>	Constant speed/frequency status word. Indicates which constant speed or frequency is active (if any). See also parameter <i>06.19 Speed control status word</i> , bit 7, and section Constant speeds/frequencies. This parameter is read-only.	-																											
		<table border="1"> <thead> <tr> <th>Bit</th> <th>Name</th> <th>Description</th> </tr> </thead> <tbody> <tr> <td>0</td> <td>Constant speed 1</td> <td>1 = Constant speed or frequency 1 selected</td> </tr> <tr> <td>1</td> <td>Constant speed 2</td> <td>1 = Constant speed or frequency 2 selected</td> </tr> <tr> <td>2</td> <td>Constant speed 3</td> <td>1 = Constant speed or frequency 3 selected</td> </tr> <tr> <td>3</td> <td>Constant speed 4</td> <td>1 = Constant speed or frequency 4 selected</td> </tr> <tr> <td>4</td> <td>Constant speed 5</td> <td>1 = Constant speed or frequency 5 selected</td> </tr> <tr> <td>5</td> <td>Constant speed 6</td> <td>1 = Constant speed or frequency 6 selected</td> </tr> <tr> <td>6</td> <td>Constant speed 7</td> <td>1 = Constant speed or frequency 7 selected</td> </tr> <tr> <td>7...15</td> <td>Reserved</td> <td></td> </tr> </tbody> </table>	Bit	Name	Description	0	Constant speed 1	1 = Constant speed or frequency 1 selected	1	Constant speed 2	1 = Constant speed or frequency 2 selected	2	Constant speed 3	1 = Constant speed or frequency 3 selected	3	Constant speed 4	1 = Constant speed or frequency 4 selected	4	Constant speed 5	1 = Constant speed or frequency 5 selected	5	Constant speed 6	1 = Constant speed or frequency 6 selected	6	Constant speed 7	1 = Constant speed or frequency 7 selected	7...15	Reserved		
Bit	Name	Description																												
0	Constant speed 1	1 = Constant speed or frequency 1 selected																												
1	Constant speed 2	1 = Constant speed or frequency 2 selected																												
2	Constant speed 3	1 = Constant speed or frequency 3 selected																												
3	Constant speed 4	1 = Constant speed or frequency 4 selected																												
4	Constant speed 5	1 = Constant speed or frequency 5 selected																												
5	Constant speed 6	1 = Constant speed or frequency 6 selected																												
6	Constant speed 7	1 = Constant speed or frequency 7 selected																												
7...15	Reserved																													
	0000h...FFFFh	Constant speed/frequency status word.	1 = 1																											
06.21	<i>Drive status word 3</i>	Drive status word 3. This parameter is read-only.	-																											
		<table border="1"> <thead> <tr> <th>Bit</th> <th>Name</th> <th>Description</th> </tr> </thead> <tbody> <tr> <td>0</td> <td>DC hold active</td> <td>1 = DC hold is active</td> </tr> <tr> <td>1</td> <td>Post-magnetizing active</td> <td>1 = Post-magnetizing is active</td> </tr> <tr> <td>2</td> <td>Motor pre-heating active</td> <td>1 = Motor pre-heating is active</td> </tr> <tr> <td>3</td> <td>PM smooth start active</td> <td>1 = PM smooth start is active</td> </tr> <tr> <td>4</td> <td>Rotor position known</td> <td>1 = Rotor position is known</td> </tr> <tr> <td>5</td> <td>DC brake active</td> <td>1 = DC brake is active</td> </tr> <tr> <td>6...15</td> <td>Reserved</td> <td></td> </tr> </tbody> </table>	Bit	Name	Description	0	DC hold active	1 = DC hold is active	1	Post-magnetizing active	1 = Post-magnetizing is active	2	Motor pre-heating active	1 = Motor pre-heating is active	3	PM smooth start active	1 = PM smooth start is active	4	Rotor position known	1 = Rotor position is known	5	DC brake active	1 = DC brake is active	6...15	Reserved					
Bit	Name	Description																												
0	DC hold active	1 = DC hold is active																												
1	Post-magnetizing active	1 = Post-magnetizing is active																												
2	Motor pre-heating active	1 = Motor pre-heating is active																												
3	PM smooth start active	1 = PM smooth start is active																												
4	Rotor position known	1 = Rotor position is known																												
5	DC brake active	1 = DC brake is active																												
6...15	Reserved																													
	0000h...FFFFh	Drive status word 1.	1 = 1																											
06.29	<i>MSW bit 10 selection</i>	Selects a binary source whose status is transmitted as bit 10 of parameter <i>06.11 Main status word</i> .	<i>Above limit</i>																											
	False	0.	0																											
	True	1.	1																											
	Above limit	Bit 10 of <i>06.17 Drive status word 2</i> .	2																											
	<i>Other [bit]</i>	Source selection (see <i>Terms and abbreviations</i>).	-																											
06.30	<i>MSW bit 11 selection</i>	Selects a binary source whose status is transmitted as bit 11 (User bit 0) of <i>06.11 Main status word</i> .	<i>Ext ctrl loc</i>																											
	False	0.	0																											
	True	1.	1																											
	Ext ctrl loc	Bit 11 of <i>06.01 Main control word</i> .	2																											
	<i>Other [bit]</i>	Source selection (see <i>Terms and abbreviations</i>).	-																											

126 Parameters

No.	Name/Value	Description	Default FbEq 16
06.31	<i>MSW bit 12 selection</i>	Selects a binary source whose status is transmitted as bit 12 (User bit 1) of <i>06.11 Main status word</i> .	<i>Ext run enable</i>
	False	0.	0
	True	1.	1
	Ext run enable	Status of the external run enable signal (see parameter <i>20.12 Run enable 1 source</i>).	2
	<i>Other [bit]</i>	Source selection (see <i>Terms and abbreviations</i>).	-
06.32	<i>MSW bit 13 selection</i>	Selects a binary source whose status is transmitted as bit 13 (User bit 2) of <i>06.11 Main status word</i> .	<i>False</i>
	False	0.	0
	True	1.	1
	<i>Other [bit]</i>	Source selection (see <i>Terms and abbreviations</i>).	-
06.33	<i>MSW bit 14 selection</i>	Selects a binary source whose status is transmitted as bit 14 (User bit 3) of <i>06.11 Main status word</i> .	<i>False</i>
	False	0.	0
	True	1.	1
	<i>Other [bit]</i>	Source selection (see <i>Terms and abbreviations</i>).	-
<i>07 System info</i>		Drive hardware and firmware information. All parameters in this group are read-only.	
07.03	<i>Drive rating id</i>	Type of the drive/inverter unit.	-
07.04	<i>Firmware name</i>	Firmware identification.	-
07.05	<i>Firmware version</i>	Version number of the firmware.	-
07.06	<i>Loading package name</i>	Name of the firmware loading package.	-
07.07	<i>Loading package version</i>	Version number of the firmware loading package.	-
07.11	<i>Cpu usage</i>	Microprocessor load in percent.	-
	0...100%	Microprocessor load.	1 = 1
07.25	<i>Customization package name</i>	First five ASCII letters of the name given to the customization package. The full name is visible under System info on the control panel or the Drive composer PC tool. _N/A_ = None.	-
07.26	<i>Customization package version</i>	Customization package version number. Also visible under System info on the control panel or the Drive composer PC tool.	-

No.	Name/Value	Description	Default FbEq 16																								
07.30	<i>Adaptive program status</i>	Shows the status of the adaptive program. See section <i>Adaptive programming</i> on page 51.	-																								
		<table border="1"> <thead> <tr> <th>Bit</th> <th>Name</th> <th>Description</th> </tr> </thead> <tbody> <tr> <td>0</td> <td>Initialized</td> <td>Adaptive program initialized.</td> </tr> <tr> <td>1</td> <td>Editing</td> <td>Adaptive program in editing state.</td> </tr> <tr> <td>2</td> <td>Edit done</td> <td>Editing of the adaptive program finished.</td> </tr> <tr> <td>3</td> <td>Running</td> <td>Adaptive program running.</td> </tr> <tr> <td>4-13</td> <td>Reserved</td> <td></td> </tr> <tr> <td>14</td> <td>State changing</td> <td>State changing on-going in the adaptive programming engine.</td> </tr> <tr> <td>15</td> <td>Faulted</td> <td>Adaptive program faulted.</td> </tr> </tbody> </table>	Bit	Name	Description	0	Initialized	Adaptive program initialized.	1	Editing	Adaptive program in editing state.	2	Edit done	Editing of the adaptive program finished.	3	Running	Adaptive program running.	4-13	Reserved		14	State changing	State changing on-going in the adaptive programming engine.	15	Faulted	Adaptive program faulted.	
Bit	Name	Description																									
0	Initialized	Adaptive program initialized.																									
1	Editing	Adaptive program in editing state.																									
2	Edit done	Editing of the adaptive program finished.																									
3	Running	Adaptive program running.																									
4-13	Reserved																										
14	State changing	State changing on-going in the adaptive programming engine.																									
15	Faulted	Adaptive program faulted.																									
	0000h...FFFFh	Adaptive program status	1 = 1																								
07.31	<i>AP sequence state</i>	Shows the number of the active state of the sequence program part of the adaptive program (AP). If adaptive programming is not running, or it does not contain a sequence program, the parameter is zero.																									
10 Standard DI, RO		Configuration of digital inputs and relay outputs.																									
10.01	<i>DI status</i>	Displays the status of digital inputs.	0000h																								
		<table border="1"> <thead> <tr> <th>Bit</th> <th>Value</th> </tr> </thead> <tbody> <tr> <td>0</td> <td>DI1 = Status of digital input 1.</td> </tr> <tr> <td>1</td> <td>DI2 = Status of digital input 2.</td> </tr> <tr> <td>2</td> <td>DI3 = Status of digital input 3.</td> </tr> <tr> <td>3</td> <td>DI4 = Status of digital input 4.</td> </tr> <tr> <td>4</td> <td>DI5 = Status of digital input 5.</td> </tr> <tr> <td>6...15</td> <td>Reserved.</td> </tr> </tbody> </table>	Bit	Value	0	DI1 = Status of digital input 1.	1	DI2 = Status of digital input 2.	2	DI3 = Status of digital input 3.	3	DI4 = Status of digital input 4.	4	DI5 = Status of digital input 5.	6...15	Reserved.											
Bit	Value																										
0	DI1 = Status of digital input 1.																										
1	DI2 = Status of digital input 2.																										
2	DI3 = Status of digital input 3.																										
3	DI4 = Status of digital input 4.																										
4	DI5 = Status of digital input 5.																										
6...15	Reserved.																										
	0000h...FFFFh	Status of digital inputs.	1 = 1																								
10.02	<i>DI delayed status</i>	Displays the status of digital inputs. This word is updated only after activation / deactivation delays.	0000h																								
		<table border="1"> <thead> <tr> <th>Bit</th> <th>Value</th> </tr> </thead> <tbody> <tr> <td>0</td> <td>DI1 = Delayed status of digital input 1.</td> </tr> <tr> <td>1</td> <td>DI2 = Delayed status of digital input 2.</td> </tr> <tr> <td>2</td> <td>DI3 = Delayed status of digital input 3.</td> </tr> <tr> <td>3</td> <td>DI4 = Delayed status of digital input 4.</td> </tr> <tr> <td>4</td> <td>DI5 = Delayed status of digital input 5.</td> </tr> <tr> <td>6...15</td> <td>Reserved.</td> </tr> </tbody> </table>	Bit	Value	0	DI1 = Delayed status of digital input 1.	1	DI2 = Delayed status of digital input 2.	2	DI3 = Delayed status of digital input 3.	3	DI4 = Delayed status of digital input 4.	4	DI5 = Delayed status of digital input 5.	6...15	Reserved.											
Bit	Value																										
0	DI1 = Delayed status of digital input 1.																										
1	DI2 = Delayed status of digital input 2.																										
2	DI3 = Delayed status of digital input 3.																										
3	DI4 = Delayed status of digital input 4.																										
4	DI5 = Delayed status of digital input 5.																										
6...15	Reserved.																										
	0000h...FFFFh	Delayed status of digital inputs.	1 = 1																								

No.	Name/Value	Description	Default FbEq 16														
10.03	DI force selection	<p>Selects the digital inputs, states of which will be controlled by parameter <i>10.04 DI forced data</i>. A bit in parameter <i>10.04 DI forced data</i> is provided for each digital input, and its value is applied whenever the corresponding bit in this parameter is 1.</p> <p>Note: Boot and power cycle reset the force selections (parameters <i>10.03</i> and <i>10.04</i>).</p>	0000h														
<table border="1"> <thead> <tr> <th>Bit</th> <th>Value</th> </tr> </thead> <tbody> <tr> <td>0</td> <td>1 = Force DI1 to value of bit 0 of parameter <i>10.04 DI forced data</i>.</td> </tr> <tr> <td>1</td> <td>1 = Force DI2 to value of bit 1 of parameter <i>10.04 DI forced data</i>.</td> </tr> <tr> <td>2</td> <td>1 = Force DI3 to value of bit 2 of parameter <i>10.04 DI forced data</i>.</td> </tr> <tr> <td>3</td> <td>1 = Force DI4 to value of bit 3 of parameter <i>10.04 DI forced data</i>.</td> </tr> <tr> <td>4</td> <td>1 = Force DI5 to value of bit 4 of parameter <i>10.04 DI forced data</i>.</td> </tr> <tr> <td>5...15</td> <td>Reserved.</td> </tr> </tbody> </table>				Bit	Value	0	1 = Force DI1 to value of bit 0 of parameter <i>10.04 DI forced data</i> .	1	1 = Force DI2 to value of bit 1 of parameter <i>10.04 DI forced data</i> .	2	1 = Force DI3 to value of bit 2 of parameter <i>10.04 DI forced data</i> .	3	1 = Force DI4 to value of bit 3 of parameter <i>10.04 DI forced data</i> .	4	1 = Force DI5 to value of bit 4 of parameter <i>10.04 DI forced data</i> .	5...15	Reserved.
Bit	Value																
0	1 = Force DI1 to value of bit 0 of parameter <i>10.04 DI forced data</i> .																
1	1 = Force DI2 to value of bit 1 of parameter <i>10.04 DI forced data</i> .																
2	1 = Force DI3 to value of bit 2 of parameter <i>10.04 DI forced data</i> .																
3	1 = Force DI4 to value of bit 3 of parameter <i>10.04 DI forced data</i> .																
4	1 = Force DI5 to value of bit 4 of parameter <i>10.04 DI forced data</i> .																
5...15	Reserved.																
0000h...FFFFh		Override selection for digital inputs.	1 = 1														
10.04	DI forced data	<p>Defines the forced values for the digital inputs selected by parameter <i>10.03 DI force selection</i>. It is only possible to force an input that has been selected in parameter <i>10.03 DI force selection</i>. Bit 0 is the forced value for DI1.</p>	0000h														
<table border="1"> <thead> <tr> <th>Bit</th> <th>Value</th> </tr> </thead> <tbody> <tr> <td>0</td> <td>Force the value of this bit to DI1, if so defined in parameter <i>10.03 DI force selection</i>.</td> </tr> <tr> <td>1</td> <td>Force the value of this bit to DI2, if so defined in parameter <i>10.03 DI force selection</i>.</td> </tr> <tr> <td>2</td> <td>Force the value of this bit to DI3, if so defined in parameter <i>10.03 DI force selection</i>.</td> </tr> <tr> <td>3</td> <td>Force the value of this bit to DI4, if so defined in parameter <i>10.03 DI force selection</i>.</td> </tr> <tr> <td>4</td> <td>Force the value of this bit to DI5, if so defined in parameter <i>10.03 DI force selection</i>.</td> </tr> <tr> <td>5...15</td> <td>Reserved.</td> </tr> </tbody> </table>				Bit	Value	0	Force the value of this bit to DI1, if so defined in parameter <i>10.03 DI force selection</i> .	1	Force the value of this bit to DI2, if so defined in parameter <i>10.03 DI force selection</i> .	2	Force the value of this bit to DI3, if so defined in parameter <i>10.03 DI force selection</i> .	3	Force the value of this bit to DI4, if so defined in parameter <i>10.03 DI force selection</i> .	4	Force the value of this bit to DI5, if so defined in parameter <i>10.03 DI force selection</i> .	5...15	Reserved.
Bit	Value																
0	Force the value of this bit to DI1, if so defined in parameter <i>10.03 DI force selection</i> .																
1	Force the value of this bit to DI2, if so defined in parameter <i>10.03 DI force selection</i> .																
2	Force the value of this bit to DI3, if so defined in parameter <i>10.03 DI force selection</i> .																
3	Force the value of this bit to DI4, if so defined in parameter <i>10.03 DI force selection</i> .																
4	Force the value of this bit to DI5, if so defined in parameter <i>10.03 DI force selection</i> .																
5...15	Reserved.																
0000h...FFFFh		Forced values of digital inputs.	1 = 1														
10.05	DI1 ON delay	Defines the activation delay for digital output DI1.	0.0 -														
<p>$t_{On} = 10.05$ DI1 ON delay $t_{Off} = 10.06$ DI1 OFF delay</p>																	
0.0 ... 3000.0 s		Activation delay for DI1.	10 = 1 -														

No.	Name/Value	Description	Default FbEq 16						
10.06	<i>DI1 OFF delay</i>	Defines the deactivation delay for digital output DI1. See parameter <i>10.05 DI1 ON delay</i> .	0.0 -						
	0.0 ... 3000.0 s	Deactivation delay for DI1.	10 = 1 -						
10.07	<i>DI2 ON delay</i>	Defines the activation delay for digital output DI2. See parameter <i>10.05 DI1 ON delay</i> .	0.0 -						
	0.0 ... 3000.0 s	Activation delay for DI2.	10 = 1 -						
10.08	<i>DI2 OFF delay</i>	Defines the deactivation delay for digital output DI2. See parameter <i>10.05 DI1 ON delay</i> .	0.0 -						
	0.0 ... 3000.0 s	Deactivation delay for DI2.	10 = 1 -						
10.09	<i>DI3 ON delay</i>	Defines the activation delay for digital output DI3. See parameter <i>10.05 DI1 ON delay</i> .	0.0 -						
	0.0 ... 3000.0 s	Activation delay for DI3.	10 = 1 -						
10.10	<i>DI3 OFF delay</i>	Defines the deactivation delay for digital output DI3. See parameter <i>10.05 DI1 ON delay</i> .	0.0 -						
	0.0 ... 3000.0 s	Deactivation delay for DI3.	10 = 1 -						
10.11	<i>DI4 ON delay</i>	Defines the activation delay for digital output DI4. See parameter <i>10.05 DI1 ON delay</i> .	0.0 -						
	0.0 ... 3000.0 s	Activation delay for DI4.	10 = 1 -						
10.12	<i>DI4 OFF delay</i>	Defines the deactivation delay for digital output DI4. See parameter <i>10.05 DI1 ON delay</i> .	0.0 -						
	0.0 ... 3000.0 s	Deactivation delay for DI4.	10 = 1 -						
10.13	<i>DI5 ON delay</i>	Defines the activation delay for digital output DI5. See parameter <i>10.05 DI1 ON delay</i> .	0.0 -						
	0.0 ... 3000.0 s	Activation delay for DI5.	10 = 1 -						
10.14	<i>DI5 OFF delay</i>	Defines the deactivation delay for digital output DI5. See parameter <i>10.05 DI1 ON delay</i> .	0.0 -						
	0.0 ... 3000.0 s	Deactivation delay for DI5.	10 = 1 -						
10.21	<i>RO status</i>	Status of relay outputs RO1.	-						
		<table border="1"> <thead> <tr> <th>Bit</th> <th>Value</th> </tr> </thead> <tbody> <tr> <td>0</td> <td>1 = RO1 is energized.</td> </tr> <tr> <td>1...15</td> <td>Reserved.</td> </tr> </tbody> </table>	Bit	Value	0	1 = RO1 is energized.	1...15	Reserved.	
Bit	Value								
0	1 = RO1 is energized.								
1...15	Reserved.								
	0000h...FFFFh	Status of relay outputs.	1 = 1						

130 Parameters

No.	Name/Value	Description	Default FbEq 16						
10.22	<i>RO force selection</i>	Selects the relay outputs that will be controlled by parameter <i>10.23</i> . The signals connected to the relay outputs can be overridden for eg. testing purposes. A bit in parameter <i>10.23 RO forced data</i> is provided for each relay output, and its value is applied whenever the corresponding bit in this parameter is 1. Note: Boot and power cycle reset the force selections (parameters <i>10.22</i> and <i>10.23</i>).	0000h						
<table border="1"> <thead> <tr> <th>Bit</th> <th>Value</th> </tr> </thead> <tbody> <tr> <td>0</td> <td>1 = Force RO1 to value of bit 0 of parameter <i>10.23 RO forced data</i> (0 = Normal mode).</td> </tr> <tr> <td>1...15</td> <td>Reserved</td> </tr> </tbody> </table>				Bit	Value	0	1 = Force RO1 to value of bit 0 of parameter <i>10.23 RO forced data</i> (0 = Normal mode).	1...15	Reserved
Bit	Value								
0	1 = Force RO1 to value of bit 0 of parameter <i>10.23 RO forced data</i> (0 = Normal mode).								
1...15	Reserved								
0000h...FFFFh		Override selection for relay outputs.	1 = 1						
10.23	<i>RO forced data</i>	Contains the values of relay outputs that are used instead of the connected signals if selected in parameter <i>10.22 RO force selection</i> . Bit 0 is the forced value for RO1. This provides the possibility to test the drive functionality without the plant wiring. Ton and Toff delays are passed.							
<table border="1"> <thead> <tr> <th>Bit</th> <th>Value</th> </tr> </thead> <tbody> <tr> <td>0</td> <td>Forced value (0 or 1) for parameter <i>10.22 RO force selection</i>.</td> </tr> <tr> <td>1...15</td> <td>Reserved</td> </tr> </tbody> </table>				Bit	Value	0	Forced value (0 or 1) for parameter <i>10.22 RO force selection</i> .	1...15	Reserved
Bit	Value								
0	Forced value (0 or 1) for parameter <i>10.22 RO force selection</i> .								
1...15	Reserved								
0000h...FFFFh		Forced RO values.	1 = 1						
10.24	<i>RO1 source</i>	Selects a drive signal to be connected to relay output RO1.	<i>Fault (-1)</i>						
Not energized		Output is not energized.	0						
Energized		Output is energized.	1						
Ready run		Bit 1 of <i>06.11 Main status word</i> .	2						
Enabled		Bit 0 of <i>06.16 Drive status word 1</i> .	4						
Started		Bit 5 of <i>06.16 Drive status word 1</i> .	5						
Magnetized		Bit 1 of <i>06.17 Drive status word 2</i> .	6						
Running		Bit 6 of <i>06.16 Drive status word 1</i> .	7						
Ready ref		Bit 2 of <i>06.11 Main status word</i> .	8						
At setpoint		Bit 8 of <i>06.11 Main status word</i> .	9						
Reverse		Bit 2 of <i>06.19 Speed control status word</i> .	10						
Zero speed		Bit 0 of <i>06.19 Speed control status word</i> .	11						
Above limit		Bit 10 of <i>06.17 Drive status word 2</i> .	12						
Warning		Bit 7 of <i>06.11 Main status word</i> .	13						
Fault		Bit 3 of <i>06.11 Main status word</i> .	14						
Fault (-1)		Inverted bit 3 of <i>06.11 Main status word</i> .	15						
Fault/Warning		A warning or fault is active.	16						

No.	Name/Value	Description	Default FbEq 16
	Overcurrent	A drive is tripped to overcurrent fault.	17
	Overvoltage	A drive is tripped to overvoltage fault.	18
	Drive temp	A drive is tripped to drive temperature fault.	19
	Undervoltage	A drive is tripped to undervoltage fault.	20
	Motor temp	A drive is tripped to motor temperature fault.	21
	Brake command	Bit 0 of <i>44.01 Brake control status</i> .	22
	Ext2 active	Bit 11 of <i>06.16 Drive status word 1</i> .	23
	Remote control	Bit 9 of <i>06.11 Main status word</i> .	24
	Supervision 1	Bit 0 of <i>32.01 Supervision status</i> .	33
	Supervision 2	Bit 1 of <i>32.01 Supervision status</i> .	34
	Supervision 3	Bit 2 of <i>32.01 Supervision status</i> .	35
	Start delay	Bit 13 of <i>06.17 Drive status word 2</i> .	39
	RO/DIO control word bit0	Bit 0 of <i>10.99 RO/DIO control word</i> .	40
	Event word 1	Parameter <i>04.40 Event word 1</i> .	53
	User load curve	Bit 3 (Outside load limit) of <i>37.01 ULC output status word</i> (see page 244).	61
	RO/DIO control word	Maps to corresponding bit in parameter <i>10.99 RO/DIO control word</i> . For example, Bit 0 of <i>10.99 RO/DIO control word</i> controls RO1.	62
	<i>Other [bit]</i>	Source selection (see <i>Terms and abbreviations</i>).	-
<i>10.25</i>	<i>RO1 ON delay</i>	Defines the activation delay for relay output RO1.	0.0
<p> $t_{on} = 10.25$ RO1 ON delay $t_{off} = 10.26$ RO1 OFF delay </p>			
	0.0 ... 3000.0 s	Activation delay for RO1.	10 = 1
<i>10.26</i>	<i>RO1 OFF delay</i>	Defines the deactivation delay for relay output RO1. See parameter <i>10.25 RO1 ON delay</i> .	0.0
	0.0 ... 3000.0 s	Deactivation delay for RO1.	10 = 1

No.	Name/Value	Description	Default FbEq 16									
10.99	<i>RO/DIO control word</i>	Storage parameter for controlling the relay outputs eg. through the embedded fieldbus interface. To control the relay outputs (RO) of the drive, send a control word with the bit assignments shown below as Modbus I/O data. Set the target selection parameter of that particular data (<i>58.101...58.114</i>) to <i>RO/DIO control word</i> . In the source selection parameter of the desired output, select the appropriate bit of this word.	0000h									
<table border="1"> <thead> <tr> <th>Bit</th> <th>Name</th> <th>Description</th> </tr> </thead> <tbody> <tr> <td>0</td> <td>RO1</td> <td>Source bits for relay outputs (see parameter <i>10.24</i>).</td> </tr> <tr> <td>8</td> <td>DO1</td> <td></td> </tr> </tbody> </table>				Bit	Name	Description	0	RO1	Source bits for relay outputs (see parameter <i>10.24</i>).	8	DO1	
Bit	Name	Description										
0	RO1	Source bits for relay outputs (see parameter <i>10.24</i>).										
8	DO1											
	0000h...FFFFh	RO control word.	1 = 1									
10.101	<i>RO1 toggle counter</i>	Displays the number of times relay output RO1 has changed states.	-									
	0...4294967000	State change count.	1 = 1									
<i>11 Standard DIO, FI, FO</i>		Configuration of the digital inputs/outputs (DIO) for use as digital inputs,										
11.02	<i>DIO delayed status</i>	Displays the delayed status of digital outputs DO1. This word is updated only after activation/deactivation delays (if any are specified). Example: 0001 = DO1 is on. This parameter is read-only.	-									
	DO1	Delayed status of digital output 1.	1 = 1									
	0000b...0001b	Status of digital outputs.	1 = 1									
11.03	<i>DIO force selection</i>	Selects the digit output that will be controlled by parameter <i>11.04</i> . The signals connected to the digit output can be overridden for eg. testing purposes. bit0 in parameter <i>11.04 DO1 force data</i> is provided for digit output, and its value is applied whenever the corresponding bit0 in this parameter is 1. Note: Boot and power cycle reset the force selections (parameters <i>11.03</i> and <i>11.04</i>).	0000h									
<table border="1"> <thead> <tr> <th>Bit</th> <th>Value</th> </tr> </thead> <tbody> <tr> <td>0</td> <td>1 = Force DO1 to value of bit 0 of parameter <i>11.04 DO1 force data</i>.</td> </tr> <tr> <td>1...15</td> <td>Reserved</td> </tr> </tbody> </table>				Bit	Value	0	1 = Force DO1 to value of bit 0 of parameter <i>11.04 DO1 force data</i> .	1...15	Reserved			
Bit	Value											
0	1 = Force DO1 to value of bit 0 of parameter <i>11.04 DO1 force data</i> .											
1...15	Reserved											
	0000h...FFFFh	Forced selections of digital inputs/outputs.	1=1									

No.	Name/Value	Description	Default FbEq 16						
11.04	<i>DO1 force data</i>	Contains the value of digit output that is used instead of the connected signals if selected in parameter 11.03 <i>DO force selection</i> . Bit 0 is the forced value for DO1. This provides the possibility to test the drive functionality without the plant wiring. T _{on} and T _{off} delays are passed.	0000h						
<table border="1"> <thead> <tr> <th>Bit</th> <th>Value</th> </tr> </thead> <tbody> <tr> <td>0</td> <td>Force the value of this bit to DO1, if so defined in parameter 11.03 DO force selection.</td> </tr> <tr> <td>1...15</td> <td>Reserved</td> </tr> </tbody> </table>				Bit	Value	0	Force the value of this bit to DO1, if so defined in parameter 11.03 DO force selection.	1...15	Reserved
Bit	Value								
0	Force the value of this bit to DO1, if so defined in parameter 11.03 DO force selection.								
1...15	Reserved								
	0000h...FFFFh	Forced values of digital outputs.	1=1						
11.06	<i>DO1 output source</i>	Selects a drive signal to be connected to digital output DO1.	<i>Not energized</i>						
	Not energized	Output is not energized.	0						
	Energized	Output is energized.	1						
	Ready run	Bit 1 of <i>06.11 Main status word</i> .	2						
	Enabled	Bit 0 of <i>06.16 Drive status word 1</i> .	4						
	Started	Bit 5 of <i>06.16 Drive status word 1</i> .	5						
	Magnetized	Bit 1 of <i>06.17 Drive status word 2</i> .	6						
	Running	Bit 6 of <i>06.16 Drive status word 1</i> .	7						
	Ready ref	Bit 2 of <i>06.11 Main status word</i> .	8						
	At setpoint	Bit 8 of <i>06.11 Main status word</i> .	9						
	Reverse	Bit 2 of <i>06.19 Speed control status word</i> .	10						
	Zero speed	Bit 0 of <i>06.19 Speed control status word</i> .	11						
	Above limit	Bit 10 of <i>06.17 Drive status word 2</i> .	12						
	Warning	Bit 7 of <i>06.11 Main status word</i> .	13						
	Fault	Bit 3 of <i>06.11 Main status word</i> .	14						
	Fault (-1)	Inverted bit 3 of <i>06.11 Main status word</i> .	15						
	Fault/Warning	A warning or fault is active.	16						
	Overcurrent	A drive is tripped to overcurrent fault.	17						
	Overvoltage	A drive is tripped to overvoltage fault.	18						
	Drive temp	A drive is tripped to drive temperature fault.	19						
	Undervoltage	A drive is tripped to undervoltage fault.	20						
	Motor temp	A drive is tripped to motor temperature fault.	21						
	Brake command	Bit 0 of <i>44.01 Brake control status</i> .	22						
	Ext2 active	Bit 11 of <i>06.16 Drive status word 1</i> .	23						
	Remote control	Bit 9 of <i>06.11 Main status word</i> .	24						
	Supervision 1	Bit 0 of <i>32.01 Supervision status</i> .	33						
	Supervision 2	Bit 1 of <i>32.01 Supervision status</i> .	34						

134 Parameters

No.	Name/Value	Description	Default FbEq 16
	Supervision 3	Bit 2 of <i>32.01 Supervision status</i> .	35
	Start delay	Bit 13 of <i>06.17 Drive status word 2</i> .	39
	RO/DIO control word bit0	Bit 0 of <i>10.99 RO/DIO control word</i> .	40
	Event word 1	Parameter <i>04.40 Event word 1</i> .	53
	User load curve	Bit 3 (Outside load limit) of <i>37.01 ULC output status word</i> (see page 244).	61
	RO/DIO control word	Maps to corresponding bit in parameter <i>10.99 RO/DIO control word</i> . For example, Bit 0 of <i>10.99 RO/DIO control word</i> controls RO1, Bit 8 of <i>10.99 RO/DIO control word</i> controls DO1, and so on.	62
	<i>Other [bit]</i>	Source selection (see <i>Terms and abbreviations</i>).	-
<i>11.07</i>	<i>DO1 ON delay</i>	Defines the on (activation) delay for digital input/output DO1 (when used as a digital output or digital input).	0.00 s
	0.0 ... 3000.0 s	Activation delay for DO1.	10 = 1 s
<i>11.08</i>	<i>DO1 OFF delay</i>	Defines the deactivation delay for digital input/output DO1 (when used as a digital output or digital input). See parameter <i>11.07 DO1 ON delay</i> .	0.00 s
	0.0 ... 3000.0 s	Deactivation delay for DO1.	10 = 1 s
<i>11.13</i>	<i>DI3 configuration</i>	Selects the type of digital input DI3: normal digital input or frequency input.	<i>Digital input</i>
	Digital input	Digital input. See parameter <i>11.42</i> for more information.	0
	Frequency input	Frequency input.	1
<i>11.17</i>	<i>DI4 configuration</i>	Selects the type of digital input DI4: normal digital input or frequency input.	<i>Digital input</i>
	Digital input	Digital input.	0
	Frequency input	Frequency input.	1
<i>11.21</i>	<i>DI5 configuration</i>	Selects the type of digital input DI5: normal digital input or analog input.	<i>Analog input</i>
	Digital input	Digital input.	0
	Analog input	Analog input.	2
<i>11.38</i>	<i>Freq in 1 actual value</i>	Displays the value of frequency input 1 before scaling. See parameter <i>11.42 Freq in 1 min</i> . This parameter is read-only.	-
	0 ... 16000 Hz	Unscaled value of frequency input 1.	1 = 1 Hz
<i>11.39</i>	<i>Freq in 1 scaled value</i>	Displays the value of frequency input 1 after scaling. See parameter <i>11.42 Freq in 1 min</i> . This parameter is read-only.	-
	-32768.000... 32767.000	Scaled value of frequency input 1.	1 = 1

No.	Name/Value	Description	Default FbEq 16
11.42	<i>Freq in 1 min</i>	<p>Defines the minimum for the frequency actually arriving at frequency input 1.</p> <p>The incoming frequency signal (11.38 <i>Freq in 1 actual value</i>) is scaled into an internal signal (11.39 <i>Freq in 1 scaled value</i>) by parameters 11.42...11.45 as follows:</p>	0 Hz
	0 ... 16000 Hz	Minimum frequency of frequency input 1.	1 = 1 Hz
11.43	<i>Freq in 1 max</i>	Defines the maximum value of the frequency signal actually arriving at frequency input 1. See parameter 11.42 <i>Freq in 1 min</i> .	16000 Hz
	0 ... 16000 Hz	Maximum frequency of frequency input 1.	1 = 1 Hz
11.44	<i>Freq in 1 at scaled min</i>	Defines the value that corresponds to the actual minimum input frequency defined by parameter 11.42 <i>Freq in 1 min</i> .	0.000
	-32768.000... 32767.000	Value corresponding to minimum of frequency input 1.	1 = 1
11.45	<i>Freq in 1 at scaled max</i>	Defines the value that corresponds to the actual maximum input frequency defined by parameter 11.43 <i>Freq in 1 max</i> . See parameter 11.42 <i>Freq in 1 min</i> .	1500.000
	-32768.000... 32767.000	Value corresponding to maximum of frequency input 1.	1 = 1
11.46	<i>Freq in 2 actual value</i>	Displays the value of frequency input 2 before scaling. See parameter 11.50 <i>Freq in 2 min</i> This parameter is read-only.	-
	0 ... 16000 Hz	Unscaled value of frequency input 2.	1 = 1 Hz
11.47	<i>Freq in 2 scaled</i>	Displays the value of frequency input 2 after scaling. See parameter 11.50 <i>Freq in 2 min</i> . This parameter is read-only.	-
	-32768.000... 32767.000	Scaled value of frequency input 2.	1 = 1
11.50	<i>Freq in 2 min</i>	Defines the minimum value for frequency input 2.	0 Hz
	0 ... 16000 Hz	Minimum frequency of frequency input 2.	1 = 1 Hz
11.51	<i>Freq in 2 max</i>	Defines the maximum value for frequency input 2.	16000 Hz
	0 ... 16000 Hz	Maximum frequency for frequency input 2.	1 = 1 Hz

No.	Name/Value	Description	Default FbEq 16
11.52	<i>Freq in 2 at scaled min</i>	Defines the real value that corresponds to the minimum frequency input 2 value defined by parameter Freq in 2 min.	0.000
	-32768.000 ... 32767.000	Value corresponding to minimum of frequency input 2.	1 = 1
11.53	<i>Freq in 2 at scaled max</i>	Defines the real value that corresponds to the maximum frequency input 2 value defined by parameter Freq in 2 max.	1500.000
	-32768.000 ... 32767.000	Value corresponding to maximum of frequency input 2.	1 = 1

12 Standard AI		Configuration of standard analog inputs.									
12.02	<i>AI force selection</i>	<p>The true readings of the analog inputs can be overridden for e.g. testing purposes. A forced value parameter is provided for each analog input, and its value is applied whenever the corresponding bit in this parameter is 1.</p> <p>Note: AI filter times (parameters <i>12.16 AI1 filter time</i> and <i>12.26 AI1 filter time</i>) have no effect on forced AI values (parameters <i>12.13 AI1 forced value</i> and <i>12.23 AI2 forced value</i>).</p> <p>Note: Boot and power cycle reset the force selections (parameter <i>12.02</i>).</p>	0000h								
<table border="1"> <thead> <tr> <th>Bit</th> <th>Value</th> </tr> </thead> <tbody> <tr> <td>0</td> <td>1 = Force AI1 to value of parameter <i>12.13 AI1 forced value</i>.</td> </tr> <tr> <td>1</td> <td>1 = Force AI2 to value of parameter <i>12.23 AI2 forced value</i>.</td> </tr> <tr> <td>2...15</td> <td>Reserved</td> </tr> </tbody> </table>		Bit	Value	0	1 = Force AI1 to value of parameter <i>12.13 AI1 forced value</i> .	1	1 = Force AI2 to value of parameter <i>12.23 AI2 forced value</i> .	2...15	Reserved		
Bit	Value										
0	1 = Force AI1 to value of parameter <i>12.13 AI1 forced value</i> .										
1	1 = Force AI2 to value of parameter <i>12.23 AI2 forced value</i> .										
2...15	Reserved										

	0000h...FFFFh	Forced values selector for analog inputs AI1 and AI2.	1 = 1
12.03	<i>AI supervision function</i>	<p>Selects how the drive reacts when an analog input signal moves out of the minimum and/or maximum limits specified for the input.</p> <p>The supervision applies a margin of 0.5 V or 1.0 mA to the limits. For example, if the maximum limit for the input is 7.000 V, the maximum limit supervision activates at 7.500 V.</p> <p>The inputs and the limits to be observed are selected by parameter <i>12.04 AI supervision selection</i>.</p>	<i>No action</i>
	No action	No action taken.	0
	Fault	Drive trips on <i>80A0 AI supervision</i> .	1
	Warning	Drive generates an <i>A8A0 AI supervision</i> warning.	2
	Last speed	<p>Drive generates a warning (<i>A8A0 AI supervision</i>) and freezes the speed (or frequency) to the level the drive was operating at. The speed/frequency is determined on the basis of actual speed using 850 ms low-pass filtering.</p> <p> WARNING! Make sure that it is safe to continue operation in case of a communication break.</p>	3

No.	Name/Value	Description	Default FbEq 16																											
	Speed ref safe	Drive generates a warning (<i>A8A0 AI supervision</i>) and sets the speed to the speed defined by parameter <i>22.41 Speed ref safe</i> (or <i>28.41 Frequency ref safe</i> when frequency reference is being used).  WARNING! Make sure that it is safe to continue operation in case of a communication break.	4																											
<i>12.04</i>	<i>AI supervision selection</i>	Specifies the analog input limits to be supervised. See parameter <i>12.03 AI supervision function</i> .	0000h																											
		<table border="1"> <thead> <tr> <th>Bit</th> <th>Name</th> <th>Description</th> </tr> </thead> <tbody> <tr> <td>0</td> <td>AI1 < MIN</td> <td>1 = Minimum limit supervision of AI1 active.</td> </tr> <tr> <td>1</td> <td>AI1 > MAX</td> <td>1 = Maximum limit supervision of AI1 active.</td> </tr> <tr> <td>2</td> <td>AI2 < MIN</td> <td>1 = Minimum limit supervision of AI2 active.</td> </tr> <tr> <td>3</td> <td>AI2 > MAX</td> <td>1 = Maximum limit supervision of AI2 active.</td> </tr> <tr> <td>4...15</td> <td>Reserved</td> <td></td> </tr> </tbody> </table>	Bit	Name	Description	0	AI1 < MIN	1 = Minimum limit supervision of AI1 active.	1	AI1 > MAX	1 = Maximum limit supervision of AI1 active.	2	AI2 < MIN	1 = Minimum limit supervision of AI2 active.	3	AI2 > MAX	1 = Maximum limit supervision of AI2 active.	4...15	Reserved											
Bit	Name	Description																												
0	AI1 < MIN	1 = Minimum limit supervision of AI1 active.																												
1	AI1 > MAX	1 = Maximum limit supervision of AI1 active.																												
2	AI2 < MIN	1 = Minimum limit supervision of AI2 active.																												
3	AI2 > MAX	1 = Maximum limit supervision of AI2 active.																												
4...15	Reserved																													
	0000h...FFFFh	Activation of analog input supervision.	1 = 1																											
<i>12.05</i>	<i>AI supervision force</i>	Activates/deactivates analog input supervision for each control location (see section <i>Local and external control locations</i> on page 46). When a control location does not utilize AI for referencing, you can use this parameter to deactivate AI supervision (<i>12.04</i>). This hides the AI supervision function (<i>12.03</i>) for the selected control location.	0b0000																											
		<table border="1"> <thead> <tr> <th>Bit</th> <th>Name</th> <th>Description</th> </tr> </thead> <tbody> <tr> <td>0</td> <td>AI1 Ext1</td> <td>1 = AI1 supervision is active when EXT1 is used.</td> </tr> <tr> <td>1</td> <td>AI1 Ext2</td> <td>1 = AI1 supervision is active when EXT2 is used.</td> </tr> <tr> <td>2</td> <td>AI1 Local</td> <td>1 = AI1 supervision is active when local control is used.</td> </tr> <tr> <td>3</td> <td>Reserved</td> <td></td> </tr> <tr> <td>4</td> <td>AI2 Ext1</td> <td>1 = AI2 supervision is active when EXT1 is used.</td> </tr> <tr> <td>5</td> <td>AI2 Ext2</td> <td>1 = AI2 supervision is active when EXT2 is used.</td> </tr> <tr> <td>6</td> <td>AI2 Local</td> <td>1 = AI2 supervision is active when local control is used.</td> </tr> <tr> <td>7...15</td> <td>Reserved</td> <td></td> </tr> </tbody> </table>	Bit	Name	Description	0	AI1 Ext1	1 = AI1 supervision is active when EXT1 is used.	1	AI1 Ext2	1 = AI1 supervision is active when EXT2 is used.	2	AI1 Local	1 = AI1 supervision is active when local control is used.	3	Reserved		4	AI2 Ext1	1 = AI2 supervision is active when EXT1 is used.	5	AI2 Ext2	1 = AI2 supervision is active when EXT2 is used.	6	AI2 Local	1 = AI2 supervision is active when local control is used.	7...15	Reserved		
Bit	Name	Description																												
0	AI1 Ext1	1 = AI1 supervision is active when EXT1 is used.																												
1	AI1 Ext2	1 = AI1 supervision is active when EXT2 is used.																												
2	AI1 Local	1 = AI1 supervision is active when local control is used.																												
3	Reserved																													
4	AI2 Ext1	1 = AI2 supervision is active when EXT1 is used.																												
5	AI2 Ext2	1 = AI2 supervision is active when EXT2 is used.																												
6	AI2 Local	1 = AI2 supervision is active when local control is used.																												
7...15	Reserved																													
	0000h...FFFFh	Activation of analog input supervision.	1 = 1																											
<i>12.11</i>	<i>AI1 actual value</i>	Displays the value of analog input AI1 in mA or V (depending on whether the input is set to current or voltage by a hardware setting). This parameter is read-only.	-																											
	0.000...22.000 mA or 0.000...11.000 V	Value of analog input AI1.	1000 = 1 unit																											
<i>12.12</i>	<i>AI1 scaled value</i>	Displays the value of analog input AI1 after scaling. See parameters <i>12.19 AI1 scaled at AI1 min</i> and <i>12.20 AI1 scaled at AI1 max</i> . This parameter is read-only.	-																											
	-32768 ... 32767	Scaled value of analog input AI1.	1 = 1																											

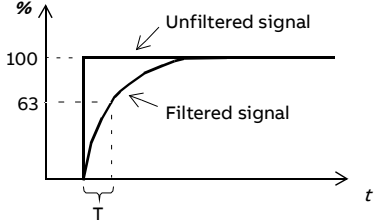
No.	Name/Value	Description	Default FbEq 16
12.13	<i>AI1 forced value</i>	Defines the forced value that can be used instead of the true reading of the input. See parameter 12.02 <i>AI force selection</i> .	-
-	-	-	1000 = 1 -
12.15	<i>AI1 unit selection</i>	Selects the unit for readings and settings related to analog input AI1. See the default control connections of the macro in use, in chapter <i>Control macros</i> (page 27).	V
	V	Volts.	2
	mA	Milliamperes.	10
12.16	<i>AI1 filter time</i>	Defines the filter time constant for analog input AI1.  $O = I \times (1 - e^{-t/T})$ <p>I = filter input (step) O = filter output t = time T = filter time constant</p> <p>Note: The signal is also filtered due to the signal interface hardware (approximately 0.25 ms time constant). This cannot be changed by any parameter.</p>	0.100 s
	0.000...30.000 s	Filter time constant.	1000 = 1 s
12.17	<i>AI1 min</i>	Defines the minimum site value for analog input AI1. Set the value actually sent to the drive when the analog signal from plant is wound to its minimum setting.	4.000 mA or 0.000 V
	0.000...22.000 mA or 0.000...11.00 V	Minimum value of AI1.	1000 = 1 mA or V
12.18	<i>AI1 max</i>	Defines the maximum site value for analog input AI1. Set the value actually sent to the drive when the analog signal from plant is wound to its maximum setting.	20.000 mA or 10.00 V
	0.000...22.000 mA or 0.000...11.00 V	Maximum value of AI1.	1000 = 1 mA or V

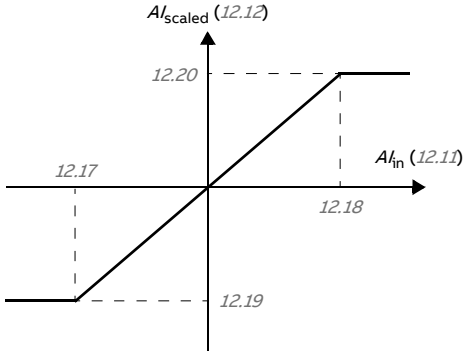
No.	Name/Value	Description	Default FbEq 16
12.19	<i>AI1 scaled at AI1 min</i>	<p>Defines the real internal value that corresponds to the minimum analog input AI1 value defined by parameter <i>12.17 AI1 min</i>. (Changing the polarity settings of <i>12.19</i> and <i>12.20</i> can effectively invert the analog input.)</p> 	0
	-32768.000... 32767.000		1 = 1
12.20	<i>AI1 scaled at AI1 max</i>	Defines the real internal value that corresponds to the maximum analog input AI1 value defined by parameter <i>12.18 AI1 max</i> . See the drawing at parameter <i>12.19 AI1 scaled at AI1 min</i> .	50.000
	-32768.000... 32767.000	Real value corresponding to maximum AI1 value.	1 = 1
12.21	<i>AI2 actual value</i>	Displays the value of analog input AI2 in mA or V (depending on whether the input is set to current or voltage by a hardware setting). This parameter is read-only.	-
	0.000...22.000 mA or 0.000...11.000 V	Value of analog input AI2.	1000 = 1 mA or V
12.22	<i>AI2 scaled value</i>	Displays the value of analog input AI2 after scaling. See parameters <i>12.29 AI2 scaled at AI2 min</i> and <i>12.101 AI1 percent value</i> . This parameter is read-only.	-
	-32768.000... 32767.000	Scaled value of analog input AI2.	1 = 1
12.23	<i>AI2 forced value</i>	Forced value that can be used instead of the true reading of the input. See parameter <i>12.02 AI force selectionn</i> .	-
	0.000...22.000 mA or 0.000...11.000 V	Forced value of analog input AI2.	1000 = 1 mA or V
12.25	<i>AI2 unit selection</i>	Selects the unit for readings and settings related to analog input AI2. See the default control connections of the macro in use, in chapter <i>Control macros</i> (page 27).	mA
	V	Volts.	2
	mA	Milliamperes.	10

140 Parameters

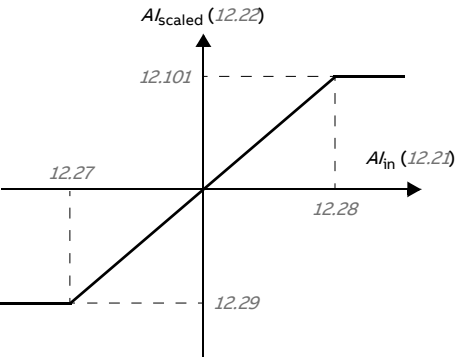
No.	Name/Value	Description	Default FbEq 16
12.26	<i>AI2 filter time</i>	Defines the filter time constant for analog input AI2. See parameter <i>12.16 AI1 filter time</i> . Note: The signal is also filtered due to the signal interface hardware (approximately 0.25 ms time constant). This cannot be changed by any parameter.	0.100 s
	0.000...30.000 s	Filter time constant.	1000 = 1 s
12.27	<i>AI2 min</i>	Defines the minimum site value for analog input AI2. Set the value actually sent to the drive when the analog signal from plant is wound to its minimum setting.	4.000 mA or 0.000 V
	0.000...22.000 mA or 0.000...11.000 V	Minimum value of AI2.	1000 = 1 mA or V
12.28	<i>AI2 max</i>	Defines the maximum site value for analog input AI2. Set the value actually sent to the drive when the analog signal from plant is wound to its maximum setting.	20.000 mA or 10.000 V
	0.000...22.000 mA or 0.000...11.000 V	Maximum value of AI2.	1000 = 1 mA or V
12.29	<i>AI2 scaled at AI2 min</i>	Defines the real value that corresponds to the minimum analog input AI2 value defined by parameter <i>12.27 AI2 min</i> . (Changing the polarity settings of <i>12.29</i> and <i>12.101</i> can effectively invert the analog input.) 	0.000
	-32768.000... 32767.000	Real value corresponding to minimum AI2 value.	1 = 1
12.30	<i>AI2 scaled at AI2 max</i>	Defines the real value that corresponds to the maximum analog input AI2 value defined by parameter <i>12.28 AI2 max</i> . See the drawing at parameter of <i>12.29 AI2 scaled at AI2 min</i>	50.000
	-32768.000... 32767.000	Real value corresponding to maximum AI2 value.	1 = 1
12.101	<i>AI1 percent value</i>	Value of analog input AI1 in percent of AI1 scaling (<i>12.18 AI1 max</i> - <i>12.17 AI1 min</i>).	-
	0.00... 100.00	AI1 value	100 = 1%
12.102	<i>AI2 percent value</i>	Value of analog input AI2 in percent of AI1 scaling (<i>12.28 AI2 max</i> - <i>12.27 AI2 min</i>).	-

No.	Name/Value	Description	Default FbEq 16
	0.00... 100.00	AI2 value	100 = 1%
12.110	<i>AI dead band</i>	AI dead band value in percentage where 100% = 10 V in voltage mode and 100% = 20 mA in current mode. Applicable to both AI1 and AI2. Note: 10% of AI dead band value is internally added in firmware as AI dead band hysteresis positive and negative. (See section <i>AI dead band</i> on page 106.)	0.40%
	0%...100%	dead band value	1 = 1

<i>13 Standard AO</i>		Configuration of standard analog outputs.							
<i>13.02</i>	<i>AO force selection</i>	Selects the analog outputs that will be forced to values defined by parameters. The true source signals of the analog outputs can be overridden for eg. testing purposes. A forced value parameter is provided for each analog output, and its value is applied whenever the corresponding bit in this parameter is 1. Note: Boot and power cycle reset the force selections (parameters <i>13.02</i> and <i>13.11</i>).	0000h						
		<table border="1"> <thead> <tr> <th>Bit</th> <th>Value</th> </tr> </thead> <tbody> <tr> <td>0</td> <td>1 = Force AO1 to value of parameter <i>13.13 AO1 forced value</i>.</td> </tr> <tr> <td>1...15</td> <td>Reserved.</td> </tr> </tbody> </table>	Bit	Value	0	1 = Force AO1 to value of parameter <i>13.13 AO1 forced value</i> .	1...15	Reserved.	
Bit	Value								
0	1 = Force AO1 to value of parameter <i>13.13 AO1 forced value</i> .								
1...15	Reserved.								

	0000h...FFFFh	Forced values selector for analog output AO1.	1 = 1
<i>13.11</i>	<i>AO1 actual value</i>	Displays the value of AO1 in mA or V. This parameter is read-only.	-
	0.000...22.000 mA 0.000...11.000 V	Value of AO1.	1 = 1 mA
<i>13.12</i>	<i>AO1 source</i>	Selects a signal to be connected to analog output AO1.	<i>Output frequency</i>
	Zero	None.	0
	Motor speed used	<i>01.01 Motor speed used</i>	1
	Output frequency	<i>01.06 Output frequency</i>	3
	Motor current	<i>01.07 Motor current</i>	4
	Motor current % of motor nom	<i>01.08 Motor current % of motor nom</i>	5
	Motor torque	<i>01.10 Motor torque</i>	6
	DC voltage	<i>01.11 DC voltage</i>	7
	Output power	<i>01.14 Output power</i>	8
	Speed ref ramp in	<i>23.01 Speed ref ramp input.</i>	10
	Speed ref ramp out	<i>23.02 Speed ref ramp output</i>	11
	Speed ref used	<i>24.01 Used speed reference</i>	12
	Freq ref used	<i>28.02 Frequency ref ramp output</i>	14
	Process PID out	<i>40.01 Process PID output actual</i>	16

142 Parameters

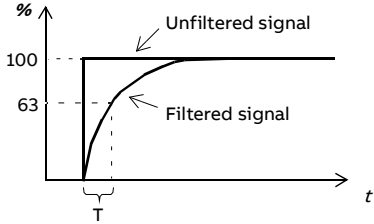
No.	Name/Value	Description	Default FbEq 16
	Temp sensor 1 excitation	The output is used to feed an excitation current to the temperature sensor 1, see parameter <i>35.11 Temperature 1 source</i> . See also section <i>Motor thermal protection</i> .	20
	Abs motor speed used	<i>01.61 Abs motor speed used</i>	26
	Abs motor speed %	<i>01.62 Abs motor speed %</i>	27
	Abs output frequency	<i>01.63 Abs output frequency</i>	28
	Abs motor torque	<i>01.64 Abs motor torque</i>	30
	Abs output power	<i>01.65 Abs output power</i>	31
	Abs motor shaft power	<i>01.68 Abs motor shaft power</i>	32
	External PID1 out	<i>71.01 External PID act value</i>	33
	AO1 data storage	<i>13.91 AO1 data storage</i>	37
	<i>Other</i>	Source selection (see <i>Terms and abbreviations</i>).	-
<i>13.13</i>	<i>AO1 forced value</i>	Forced value that can be used instead of the selected output signal. See parameter <i>13.02 AO force selection</i> .	0.000 mA
	-		1000 = 1 -
<i>13.15</i>	<i>AO1 unit selection</i>	Selects the unit for readings and settings related to analog input AO1. Note: See the default control connections for the macro in use in chapter <i>Control macros</i> . Control board reboot (either by cycling the power or through parameter <i>96.08 Control board boot</i>) is required to validate any changes in the hardware settings.	<i>mA</i>
	V	Volts.	2
	mA	Milliamperes.	10
<i>13.16</i>	<i>AO1 filter time</i>	Defines the filtering time constant for analog output AO1.  $O = I \times (1 - e^{-t/T})$ I = filter input (step) O = filter output t = time T = filter time constant	0.100 s
	0.000 ... 30.000 s	Filter time constant.	1000 = 1 s

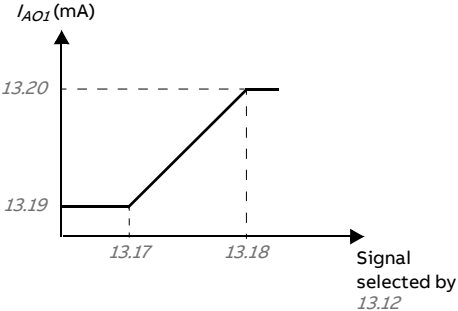
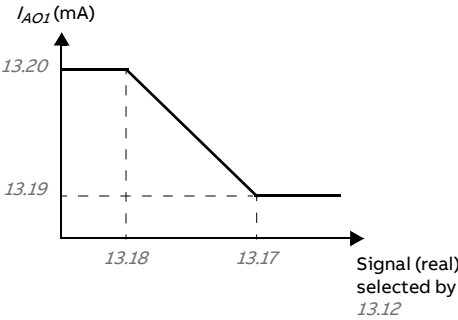
No.	Name/Value	Description	Default FbEq 16
13.17	<i>AO1 source min</i>	<p data-bbox="423 196 897 284">Defines the real minimum value of the signal (selected by parameter <i>13.12 AO1 source</i>) that corresponds to the minimum required AO1 output value (defined by parameter <i>13.19 AO1 out at AO1 src min</i>).</p>  <p data-bbox="423 663 897 707">Setting <i>13.17</i> to the maximum value and <i>13.18</i> to the minimum value inverts the output.</p> 	0.0

144 Parameters

No.	Name/Value	Description	Default FbEq 16
<p>AO has automatic scaling. Every time the source for the AO is changed, the scaling range is changed accordingly. User given minimum and maximum values override the automatic values.</p>			
	<i>13.12 AO1 source</i>	<i>13.17 AO1 source min</i>	<i>13.18 AO1 source max</i>
0	Zero	N/A (Output is constant zero.)	
1	Motor speed used	0	46.01 Speed scaling
3	Output frequency	0	46.02 Frequency scaling
4	Motor current	0	Max. value of 30.17 Maximum current
5	Motor current % of motor nom	0%	100%
6	Motor torque	0	46.03 Torque scaling
7	DC voltage	Min. value of 01.11 DC voltage	Max. value of 01.11 DC voltage
8	Output power	0	46.04 Power scaling
10	Speed ref ramp in	0	46.01 Speed scaling
11	Speed ref ramp out	0	46.01 Speed scaling
12	Speed ref used	0	46.01 Speed scaling
14	Freq ref used	0	46.02 Frequency scaling
16	Process PID out	Min. value of 40.01 Process PID output actual	Max. value of 40.01 Process PID output actual
20	Temp sensor 1 excitation	N/A (Analog output is not scaled; it is determined by the sensor's triggering voltage.)	
21	Temp sensor 2 excitation		
26	Abs motor speed used	0	46.01 Speed scaling
27	Abs motor speed %	0	46.01 Speed scaling
28	Abs output frequency	0	46.02 Frequency scaling
30	Abs motor torque	0	46.03 Torque scaling
31	Abs output power	0	46.04 Power scaling
32	Abs motor shaft power	0	46.04 Power scaling
33	External PID1 out	Min. value of 71.01 External PID act value	Max. value of 71.01 External PID act value
	Other	Min. value of the selected parameter	Max. value of the selected parameter
	-32768.0...32767.0	Real signal value corresponding to minimum AO1 output value.	1 = 1
13.18	AO1 source max	Defines the real maximum value of the signal (selected by parameter <i>13.12 AO1 source</i>) that corresponds to the maximum required AO1 output value (defined by parameter <i>13.20 AO1 out at AO1 src max</i>). See parameter <i>13.17 AO1 source min</i> .	50.0
	-32768.0...32767.0	Real signal value corresponding to maximum AO1 output value.	1 = 1
13.19	AO1 out at AO1 src min	Defines the minimum output value for analog output AO1. See also drawing at parameter <i>13.17 AO1 source min</i> .	0.000 mA
	0.000...22.00 mA 0.000...11.000 V	Minimum AO1 output value.	1000 = 1 mA

No.	Name/Value	Description	Default FbEq 16
13.20	AO1 out at AO1 src max	Defines the maximum output value for analog output AO1. See also drawing at parameter 13.18 AO1 source max.	20.000 mA
	0.000...22.000 mA 0.000...11.000 V	Maximum AO1 output value.	1000 = 1 mA
13.91	AO1 data storage	Storage parameter for controlling analog output AO1 eg. through fieldbus. In parameter 13.12 AO1 source, select AO1 data storage. Then set this parameter as the target of the incoming value data. With the embedded fieldbus interface, simply set the target selection parameter of that particular data (58.101...58.114 to AO1 data storage).	0.00
	-327.68 ... 327.67	Storage parameter for AO1.	100 = 1
19 Operation mode		Selection of local and external control location sources and operating modes. See section <i>Operating modes of the drive</i> in chapter <i>Program features</i> .	
19.01	Actual operation mode	Displays the operating mode currently used. See parameters 19.11...19.14. This parameter is read-only.	Scalar (Hz)
	Zero	None.	1
	Speed	Speed control (in vector motor control mode).	2
	Torque	Torque control (in vector motor control mode).	3
	Min	The torque selector is comparing the output of the speed controller (25.01 Torque reference speed control) and torque reference (26.74 Torque ref ramp out) and the smaller of the two is used (in vector motor control mode).	4
	Max	The torque selector is comparing the output of the speed controller (25.01 Torque reference speed control) and torque reference (26.74 Torque ref ramp out) and the greater of the two is used (in vector motor control mode).	5
	Add	The speed controller output is added to the torque reference (in vector motor control mode).	6
	Reserved		7...9
	Scalar (Hz)	Frequency control in scalar motor control mode.	10
	Forced magn.	Motor is in magnetizing mode.	20
19.11	Ext1/Ext2 selection	Selects the source for external control location EXT1/EXT2 selection. 0 = EXT1 1 = EXT2	EXT1
	EXT1	EXT1 (permanently selected).	0
	EXT2	EXT2 (permanently selected).	1
	DI1	Digital input DI1 (10.02 DI delayed status, bit 0).	3
	DI2	Digital input DI2 (10.02 DI delayed status, bit 1).	4
	DI3	Digital input DI3 (10.02 DI delayed status, bit 2).	5

146 Parameters

No.	Name/Value	Description	Default FbEq 16
	DI4	Digital input DI4 (<i>10.02 DI delayed status</i> , bit 3).	6
	DI5	Digital input DI5 (<i>10.02 DI delayed status</i> , bit 4).	7
	Supervision 1	Bit 0 of <i>32.01 Supervision status</i> .	25
	Supervision 2	Bit 1 of <i>32.01 Supervision status</i> .	26
	Supervision 3	Bit 2 of <i>32.01 Supervision status</i> .	27
	Supervision 4	Bit 3 of <i>32.01 Supervision status</i> .	28
	Supervision 5	Bit 4 of <i>32.01 Supervision status</i> .	29
	Supervision 6	Bit 5 of <i>32.01 Supervision status</i> .	30
	EFB MCW bit 11	Control word bit 11 received through the embedded fieldbus interface.	32
	EFB connection loss	Detected communication loss of embedded fieldbus interface changes control mode to EXT2.	35
	<i>Other [bit]</i>	Source selection (see <i>Terms and abbreviations</i>).	-
<i>19.12</i>	<i>Ext1 control mode</i>	Selects the operating mode for external control location EXT1 in vector motor control mode.	<i>Speed</i>
	Zero	None.	1
	Speed	Speed control. The torque reference used is <i>25.01 Torque reference speed control</i> (output of the speed reference chain).	2
	Torque	Torque control. The torque reference used is <i>26.74 Torque ref ramp out</i> (output of the torque reference chain).	3
	Minimum	Combination of selections <i>Speed</i> and <i>Torque</i> : the torque selector compares the speed controller output (<i>25.01 Torque reference speed control</i>) and the torque reference (<i>26.74 Torque ref ramp out</i>) and selects the smaller of the two. If speed error becomes negative, the drive follows the speed controller output until speed error becomes positive again. This prevents the drive from accelerating uncontrollably if the load is lost in torque control.	4
	Maximum	Combination of selections <i>Speed</i> and <i>Torque</i> : the torque selector compares the speed controller output (<i>25.01 Torque reference speed control</i>) and the torque reference (<i>26.74 Torque ref ramp out</i>) and selects the greater of the two. If speed error becomes positive, the drive follows the speed controller output until speed error becomes negative again. This prevents the drive from accelerating uncontrollably if the load is lost in torque control.	5
<i>19.14</i>	<i>Ext2 control mode</i>	Selects the operating mode for external control location EXT2 in vector motor control mode. For the selections, see parameter <i>19.12 Ext1 control mode</i> .	<i>Speed</i>

No.	Name/Value	Description	Default FbEq 16												
19.16	Local control mode	Selects the operating mode for local control in vector motor control mode.	Speed												
	Speed	Speed control. The torque reference used is 25.01 Torque reference speed control (output of the speed reference chain).	0												
	Torque	Torque control. The torque reference used is 26.74 Torque ref ramp out (output of the torque reference chain).	1												
19.17	Local control disable	Enables/disables local control (start and stop buttons on the control panel, and the local controls on the PC tool).  WARNING! Before disabling local control, ensure that the control panel is not needed for stopping the drive.	No												
	No	Local control enabled.	0												
	Yes	Local control disabled.	1												
20 Start/stop/direction		Start/stop/direction and run/start/jog enable signal source selection; positive/negative reference enable signal source selection. For information on control locations, see section <i>Local and external control locations</i> (page 46).													
20.01	Ext1 commands	Selects the source of start, stop and direction commands for external control location 1 (EXT1). See also parameters 20.02...20.05. See parameter 20.21 for the determination of the actual direction.	In1 Start; In2 Dir												
	Not selected	No start or stop command sources selected.	0												
	In1 Start	The source of the start and stop commands is selected by parameter 20.03 Ext1 in1 source. The state transitions of the source bits are interpreted as follows: <table border="1" data-bbox="423 965 766 1061"> <thead> <tr> <th>State of source 1 (20.03)</th> <th>Command</th> </tr> </thead> <tbody> <tr> <td>0 -> 1 (20.02 = Edge)</td> <td>Start</td> </tr> <tr> <td>1 (20.02 = Level)</td> <td>Stop</td> </tr> <tr> <td>0</td> <td>Stop</td> </tr> </tbody> </table>	State of source 1 (20.03)	Command	0 -> 1 (20.02 = Edge)	Start	1 (20.02 = Level)	Stop	0	Stop	1				
State of source 1 (20.03)	Command														
0 -> 1 (20.02 = Edge)	Start														
1 (20.02 = Level)	Stop														
0	Stop														
	In1 Start; In2 Dir	The source selected by 20.03 Ext1 in1 source is the start signal; the source selected by 20.04 Ext1 in2 source determines the direction. The state transitions of the source bits are interpreted as follows: <table border="1" data-bbox="423 1220 904 1356"> <thead> <tr> <th>State of source 1 (20.03)</th> <th>State of source 2 (20.04)</th> <th>Command</th> </tr> </thead> <tbody> <tr> <td>0</td> <td>Any</td> <td>Stop</td> </tr> <tr> <td>0 -> 1 (20.02 = Edge)</td> <td>0</td> <td>Start forward</td> </tr> <tr> <td>1 (20.02 = Level)</td> <td>1</td> <td>Start reverse</td> </tr> </tbody> </table>	State of source 1 (20.03)	State of source 2 (20.04)	Command	0	Any	Stop	0 -> 1 (20.02 = Edge)	0	Start forward	1 (20.02 = Level)	1	Start reverse	2
State of source 1 (20.03)	State of source 2 (20.04)	Command													
0	Any	Stop													
0 -> 1 (20.02 = Edge)	0	Start forward													
1 (20.02 = Level)	1	Start reverse													

No.	Name/Value	Description	Default FbEq 16																
	In1 Start fwd; In2 Start rev	The source selected by <i>20.03 Ext1 in1 source</i> is the forward start signal; the source selected by <i>20.04 Ext1 in2 source</i> is the reverse start signal. The state transitions of the source bits are interpreted as follows: <table border="1" data-bbox="364 316 854 502"> <thead> <tr> <th>State of source 1 (20.03)</th> <th>State of source 2 (20.04)</th> <th>Command</th> </tr> </thead> <tbody> <tr> <td>0</td> <td>0</td> <td>Stop</td> </tr> <tr> <td>0 -> 1 (20.02 = Edge) 1 (20.02 = Level)</td> <td>0</td> <td>Start forward</td> </tr> <tr> <td>0</td> <td>0 -> 1 (20.02 = Edge) 1 (20.02 = Level)</td> <td>Start reverse</td> </tr> <tr> <td>1</td> <td>1</td> <td>Stop</td> </tr> </tbody> </table>	State of source 1 (20.03)	State of source 2 (20.04)	Command	0	0	Stop	0 -> 1 (20.02 = Edge) 1 (20.02 = Level)	0	Start forward	0	0 -> 1 (20.02 = Edge) 1 (20.02 = Level)	Start reverse	1	1	Stop	3	
State of source 1 (20.03)	State of source 2 (20.04)	Command																	
0	0	Stop																	
0 -> 1 (20.02 = Edge) 1 (20.02 = Level)	0	Start forward																	
0	0 -> 1 (20.02 = Edge) 1 (20.02 = Level)	Start reverse																	
1	1	Stop																	
	In1P Start; In2 Stop	The sources of the start and stop commands are selected by parameters <i>20.03 Ext1 in1 source</i> and <i>20.04 Ext1 in2 source</i> . The state transitions of the source bits are interpreted as follows: <table border="1" data-bbox="364 651 854 746"> <thead> <tr> <th>State of source 1 (20.03)</th> <th>State of source 2 (20.04)</th> <th>Command</th> </tr> </thead> <tbody> <tr> <td>0 -> 1</td> <td>1</td> <td>Start</td> </tr> <tr> <td>Any</td> <td>0</td> <td>Stop</td> </tr> </tbody> </table> <p>Notes:</p> <ul style="list-style-type: none"> Parameter <i>20.02 Ext1 start trigger type</i> has no effect with this setting. When source 2 is 0, the Start and Stop keys on the control panel are disabled. 	State of source 1 (20.03)	State of source 2 (20.04)	Command	0 -> 1	1	Start	Any	0	Stop	4							
State of source 1 (20.03)	State of source 2 (20.04)	Command																	
0 -> 1	1	Start																	
Any	0	Stop																	
	In1P Start; In2 Stop; In3 Dir	The sources of the start and stop commands are selected by parameters <i>20.03 Ext1 in1 source</i> and <i>20.04 Ext1 in2 source</i> . The source selected by <i>20.05 Ext1 in3 source</i> determines the direction. The state transitions of the source bits are interpreted as follows: <table border="1" data-bbox="364 1042 854 1177"> <thead> <tr> <th>State of source 1 (20.03)</th> <th>State of source 2 (20.04)</th> <th>State of source 3 (20.05)</th> <th>Command</th> </tr> </thead> <tbody> <tr> <td>0 -> 1</td> <td>1</td> <td>0</td> <td>Start forward</td> </tr> <tr> <td>0 -> 1</td> <td>1</td> <td>1</td> <td>Start reverse</td> </tr> <tr> <td>Any</td> <td>0</td> <td>Any</td> <td>Stop</td> </tr> </tbody> </table> <p>Notes:</p> <ul style="list-style-type: none"> Parameter <i>20.02 Ext1 start trigger type</i> has no effect with this setting. When source 2 is 0, the Start and Stop keys on the control panel are disabled. 	State of source 1 (20.03)	State of source 2 (20.04)	State of source 3 (20.05)	Command	0 -> 1	1	0	Start forward	0 -> 1	1	1	Start reverse	Any	0	Any	Stop	5
State of source 1 (20.03)	State of source 2 (20.04)	State of source 3 (20.05)	Command																
0 -> 1	1	0	Start forward																
0 -> 1	1	1	Start reverse																
Any	0	Any	Stop																

No.	Name/Value	Description	Default FbEq 16																
	In1P Start fwd; In2P Start rev; In3 Stop	<p>The sources of the start and stop commands are selected by parameter <i>20.05 Ext1 in3 source</i>. The source selected by parameters <i>20.03 Ext1 in1 source</i> and <i>20.04 Ext1 in2 source</i> determines the direction. The state transitions of the source bits are interpreted as follows:</p> <table border="1"> <thead> <tr> <th>State of source 1 (<i>20.03</i>)</th> <th>State of source 2 (<i>20.04</i>)</th> <th>State of source 3 (<i>20.05</i>)</th> <th>Command</th> </tr> </thead> <tbody> <tr> <td>0 -> 1</td> <td>Any</td> <td>1</td> <td>Start forward</td> </tr> <tr> <td>Any</td> <td>0 -> 1</td> <td>1</td> <td>Start reverse</td> </tr> <tr> <td>Any</td> <td>Any</td> <td>0</td> <td>Stop</td> </tr> </tbody> </table> <p>Note: Parameter <i>20.02 Ext1 start trigger type</i> has no effect with this setting.</p>	State of source 1 (<i>20.03</i>)	State of source 2 (<i>20.04</i>)	State of source 3 (<i>20.05</i>)	Command	0 -> 1	Any	1	Start forward	Any	0 -> 1	1	Start reverse	Any	Any	0	Stop	6
State of source 1 (<i>20.03</i>)	State of source 2 (<i>20.04</i>)	State of source 3 (<i>20.05</i>)	Command																
0 -> 1	Any	1	Start forward																
Any	0 -> 1	1	Start reverse																
Any	Any	0	Stop																
	Control panel	Start; stop and direction commands through control panel; when EXT1 is active. Applies also for PC-Tool when it is connected via panel port.	11																
	Embedded fieldbus	The start and stop commands are taken from the embedded fieldbus interface. Note: The start signal is always level-triggered with this setting regardless of parameter <i>20.02 Ext1 start trigger type</i> .	14																
	Integrated Panel	Start; stop and direction commands from Integrated Panel	23																
<i>20.02</i>	<i>Ext1 start trigger type</i>	Defines whether the start signal for external control location EXT1 is edge-triggered or level-triggered. Note: This parameter is not effective if a pulse-type start signal is selected. See the descriptions of the selections of parameter <i>20.01 Ext1 commands</i> .	<i>Level</i>																
	Edge	The start signal is edge-triggered.	0																
	Level	The start signal is level-triggered.	1																
<i>20.03</i>	<i>Ext1 in1 source</i>	Selects source 1 for parameter <i>20.01 Ext1 commands</i> .	<i>DI1</i>																
	Always off	0 (always off).	0																
	Always on	1 (always on).	1																
	DI1	Digital input DI1 (<i>10.02 DI delayed status</i> , bit 0).	2																
	DI2	Digital input DI2 (<i>10.02 DI delayed status</i> , bit 1).	3																
	DI3	Digital input DI3 (<i>10.02 DI delayed status</i> , bit 2).	4																
	DI4	Digital input DI4 (<i>10.02 DI delayed status</i> , bit 3).	5																
	DI5	Digital input DI5 (<i>10.02 DI delayed status</i> , bit 4).	6																
	Supervision 1	Bit 0 of <i>32.01 Supervision status</i> .	24																
	Supervision 2	Bit 1 of <i>32.01 Supervision status</i> .	25																
	Supervision 3	Bit 2 of <i>32.01 Supervision status</i> .	26																
	Supervision 4	Bit 3 of <i>32.01 Supervision status</i> .	27																
	Supervision 5	Bit 4 of <i>32.01 Supervision status</i> .	28																
	Supervision 6	Bit 5 of <i>32.01 Supervision status</i> .	29																
	<i>Other [bit]</i>	Source selection (see <i>Terms and abbreviations</i>).	-																

150 Parameters

No.	Name/Value	Description	Default FbEq 16																	
20.04	Ext1 in2 source	Selects source 2 for parameter 20.01 Ext1 commands. For the available selections, see parameter 20.03 Ext1 in1 source.	DI2																	
20.05	Ext1 in3 source	Selects source 3 for parameter 20.01 Ext1 commands. For the available selections, see parameter 20.03 Ext1 in1 source.	Always off																	
20.06	Ext2 commands	Selects the source of start, stop and direction commands for external control location 2 (EXT2). See also parameters 20.07...20.10. See parameter 20.21 for the determination of the actual direction.	Not selected																	
	Not selected	No start or stop command sources selected.	0																	
	In1 Start	The source of the start and stop commands is selected by parameter 20.08 Ext2 in1 source. The state transitions of the source bits are interpreted as follows: <table border="1" data-bbox="370 579 720 673"> <thead> <tr> <th>State of source 1 (20.08)</th> <th>Command</th> </tr> </thead> <tbody> <tr> <td>0 -> 1 (20.07= Edge)</td> <td>Start</td> </tr> <tr> <td>1 (20.07= Level)</td> <td>Stop</td> </tr> <tr> <td>0</td> <td>Stop</td> </tr> </tbody> </table>	State of source 1 (20.08)	Command	0 -> 1 (20.07= Edge)	Start	1 (20.07= Level)	Stop	0	Stop	1									
State of source 1 (20.08)	Command																			
0 -> 1 (20.07= Edge)	Start																			
1 (20.07= Level)	Stop																			
0	Stop																			
	In1 Start; In2 Dir	The source selected by 20.08 Ext2 in1 source is the start signal; the source selected by 20.09 Ext2 in2 source determines the direction. The state transitions of the source bits are interpreted as follows: <table border="1" data-bbox="370 834 846 992"> <thead> <tr> <th>State of source 1 (20.08)</th> <th>State of source 2 (20.09)</th> <th>Command</th> </tr> </thead> <tbody> <tr> <td>0</td> <td>Any</td> <td>Stop</td> </tr> <tr> <td rowspan="2">0 -> 1 (20.07= Edge) 1 (20.07= Level)</td> <td>0</td> <td>Start forward</td> </tr> <tr> <td>1</td> <td>Start reverse</td> </tr> </tbody> </table>	State of source 1 (20.08)	State of source 2 (20.09)	Command	0	Any	Stop	0 -> 1 (20.07= Edge) 1 (20.07= Level)	0	Start forward	1	Start reverse	2						
State of source 1 (20.08)	State of source 2 (20.09)	Command																		
0	Any	Stop																		
0 -> 1 (20.07= Edge) 1 (20.07= Level)	0	Start forward																		
	1	Start reverse																		
	In1 Start fwd; In2 Start rev	The source selected by 20.08 Ext2 in1 source is the forward start signal; the source selected by 20.09 Ext1 in2 source is the reverse start signal. The state transitions of the source bits are interpreted as follows: <table border="1" data-bbox="370 1134 846 1318"> <thead> <tr> <th>State of source 1 (20.08)</th> <th>State of source 2 (20.09)</th> <th>Command</th> </tr> </thead> <tbody> <tr> <td>0</td> <td>0</td> <td>Stop</td> </tr> <tr> <td rowspan="2">0 -> 1 (20.07= Edge) 1 (20.07= Level)</td> <td>0</td> <td>Start forward</td> </tr> <tr> <td>0 -> 1 (20.07= Edge) 1 (20.07= Level)</td> <td>Start reverse</td> </tr> <tr> <td>0</td> <td>0 -> 1 (20.07= Edge) 1 (20.07= Level)</td> <td>Start reverse</td> </tr> <tr> <td>1</td> <td>1</td> <td>Stop</td> </tr> </tbody> </table>	State of source 1 (20.08)	State of source 2 (20.09)	Command	0	0	Stop	0 -> 1 (20.07= Edge) 1 (20.07= Level)	0	Start forward	0 -> 1 (20.07= Edge) 1 (20.07= Level)	Start reverse	0	0 -> 1 (20.07= Edge) 1 (20.07= Level)	Start reverse	1	1	Stop	3
State of source 1 (20.08)	State of source 2 (20.09)	Command																		
0	0	Stop																		
0 -> 1 (20.07= Edge) 1 (20.07= Level)	0	Start forward																		
	0 -> 1 (20.07= Edge) 1 (20.07= Level)	Start reverse																		
0	0 -> 1 (20.07= Edge) 1 (20.07= Level)	Start reverse																		
1	1	Stop																		

No.	Name/Value	Description	Default FbEq 16																
	In1P Start; In2 Stop	<p>The sources of the start and stop commands are selected by parameters <i>20.08 Ext2 in1 source</i> and <i>20.09 Ext1 in2 source</i>. The state transitions of the source bits are interpreted as follows:</p> <table border="1" data-bbox="423 293 889 384"> <thead> <tr> <th>State of source 1 (<i>20.08</i>)</th> <th>State of source 2 (<i>20.09</i>)</th> <th>Command</th> </tr> </thead> <tbody> <tr> <td>0 -> 1</td> <td>1</td> <td>Start</td> </tr> <tr> <td>Any</td> <td>0</td> <td>Stop</td> </tr> </tbody> </table> <p>Notes:</p> <ul style="list-style-type: none"> Parameter <i>20.07 Ext2 start trigger type</i> has no effect with this setting. When source 2 is 0, the Start and Stop keys on the control panel are disabled. 	State of source 1 (<i>20.08</i>)	State of source 2 (<i>20.09</i>)	Command	0 -> 1	1	Start	Any	0	Stop	4							
State of source 1 (<i>20.08</i>)	State of source 2 (<i>20.09</i>)	Command																	
0 -> 1	1	Start																	
Any	0	Stop																	
	In1P Start; In2 Stop; In3 Dir	<p>The sources of the start and stop commands are selected by parameters <i>20.08 Ext2 in1 source</i> and <i>20.09 Ext1 in2 source</i>. The source selected by <i>20.10 Ext2 in3 source</i> determines the direction. The state transitions of the source bits are interpreted as follows:</p> <table border="1" data-bbox="423 683 874 818"> <thead> <tr> <th>State of source 1 (<i>20.08</i>)</th> <th>State of source 2 (<i>20.09</i>)</th> <th>State of source 3 (<i>20.10</i>)</th> <th>Command</th> </tr> </thead> <tbody> <tr> <td>0 -> 1</td> <td>1</td> <td>0</td> <td>Start forward</td> </tr> <tr> <td>0 -> 1</td> <td>1</td> <td>1</td> <td>Start reverse</td> </tr> <tr> <td>Any</td> <td>0</td> <td>Any</td> <td>Stop</td> </tr> </tbody> </table> <p>Notes:</p> <ul style="list-style-type: none"> Parameter <i>20.07 Ext2 start trigger type</i> has no effect with this setting. When source 2 is 0, the Start and Stop keys on the control panel are disabled. 	State of source 1 (<i>20.08</i>)	State of source 2 (<i>20.09</i>)	State of source 3 (<i>20.10</i>)	Command	0 -> 1	1	0	Start forward	0 -> 1	1	1	Start reverse	Any	0	Any	Stop	5
State of source 1 (<i>20.08</i>)	State of source 2 (<i>20.09</i>)	State of source 3 (<i>20.10</i>)	Command																
0 -> 1	1	0	Start forward																
0 -> 1	1	1	Start reverse																
Any	0	Any	Stop																
	In1P Start fwd; In2P Start rev; In3 Stop	<p>The sources of the start and stop commands are selected by parameters <i>20.08 Ext2 in1 source</i>, <i>20.09 Ext1 in2 source</i> and <i>20.10 Ext2 in3 source</i>. The source selected by <i>20.10 Ext2 in3 source</i> determines the direction. The state transitions of the source bits are interpreted as follows:</p> <table border="1" data-bbox="423 1114 871 1249"> <thead> <tr> <th>State of source 1 (<i>20.08</i>)</th> <th>State of source 2 (<i>20.09</i>)</th> <th>State of source 3 (<i>20.10</i>)</th> <th>Command</th> </tr> </thead> <tbody> <tr> <td>0 -> 1</td> <td>Any</td> <td>1</td> <td>Start forward</td> </tr> <tr> <td>Any</td> <td>0 -> 1</td> <td>1</td> <td>Start reverse</td> </tr> <tr> <td>Any</td> <td>Any</td> <td>0</td> <td>Stop</td> </tr> </tbody> </table> <p>Note: Parameter <i>20.07 Ext2 start trigger type</i> has no effect with this setting.</p>	State of source 1 (<i>20.08</i>)	State of source 2 (<i>20.09</i>)	State of source 3 (<i>20.10</i>)	Command	0 -> 1	Any	1	Start forward	Any	0 -> 1	1	Start reverse	Any	Any	0	Stop	6
State of source 1 (<i>20.08</i>)	State of source 2 (<i>20.09</i>)	State of source 3 (<i>20.10</i>)	Command																
0 -> 1	Any	1	Start forward																
Any	0 -> 1	1	Start reverse																
Any	Any	0	Stop																
	Control panel	Start; stop and direction commands through control panel; when EXT1 is active. Applies also for PC-Tool when it is connected via panel port.	11																

No.	Name/Value	Description	Default FbEq 16
	Embedded fieldbus	Start; stop and direction commands through embedded fieldbus protocol when EXT1 is active. Note: The start signal is always level-triggered with this setting regardless of parameter <i>20.02 Ext1 start trigger type</i> .	14
	Integrated Panel	Start; stop and direction commands from Integrated Panel	23
<i>20.07</i>	<i>Ext2 start trigger type</i>	Defines whether the start signal for external control location EXT2 is edge-triggered or level-triggered. Note: This parameter is not effective if a pulse-type start signal is selected. See the descriptions of the selections of parameter <i>20.06 Ext2 commands</i> .	<i>Level</i>
	Edge	The start signal is edge-triggered.	0
	Level	The start signal is level-triggered.	1
<i>20.08</i>	<i>Ext2 in1 source</i>	Selects source 1 for parameter <i>20.06 Ext2 commands</i> . For the available selections, see parameter <i>20.03 Ext1 in1 source</i> .	<i>Always off</i>
<i>20.09</i>	<i>Ext2 in2 source</i>	Selects source 2 for parameter <i>20.06 Ext2 commands</i> . For the available selections, see parameter <i>20.03 Ext1 in1 source</i> .	<i>Always off</i>
<i>20.10</i>	<i>Ext2 in3 source</i>	Selects source 3 for parameter <i>20.06 Ext2 commands</i> . For the available selections, see parameter <i>20.03 Ext1 in1 source</i> .	<i>Always off</i>
<i>20.11</i>	<i>Run enable stop mode</i>	Selects the way the motor is stopped when the run enable signal switches off. The source of the run enable signal is selected by parameter <i>20.12 Run enable 1 source</i> .	<i>Coast</i>
	Coast	Stop by switching off the output semiconductors of the drive. The motor coasts to a stop.  WARNING! If a mechanical brake is used, ensure it is safe to stop the drive by coasting.	0
	Ramp	Stop along the active deceleration ramp. See parameter group <i>23 Speed reference ramp</i> .	1
	Torque limit	Stop according to torque limits (parameters <i>30.19</i> and <i>30.20</i>).	2
<i>20.12</i>	<i>Run enable 1 source</i>	Selects the source of the external run enable signal. If the run enable signal is switched off, the drive will not start. If already running, the drive will stop according to the setting of parameter <i>20.11 Run enable stop mode</i> . 1 = Run enable signal on. See also parameter <i>20.19 Enable start command</i> .	<i>Selected</i>
	Not selected	0.	0
	Selected	1.	1
	DI1	Digital input DI1 (<i>10.02 DI delayed status</i> , bit 0).	2
	DI2	Digital input DI2 (<i>10.02 DI delayed status</i> , bit 1).	3
	DI3	Digital input DI3 (<i>10.02 DI delayed status</i> , bit 2).	4
	DI4	Digital input DI4 (<i>10.02 DI delayed status</i> , bit 3).	5
	DI5	Digital input DI5 (<i>10.02 DI delayed status</i> , bit 4).	6

No.	Name/Value	Description	Default FbEq 16
	Supervision 1	Bit 0 of <i>32.01 Supervision status</i> .	24
	Supervision 2	Bit 1 of <i>32.01 Supervision status</i> .	25
	Supervision 3	Bit 2 of <i>32.01 Supervision status</i> .	26
	Supervision 4	Bit 3 of <i>32.01 Supervision status</i> .	27
	Supervision 5	Bit 4 of <i>32.01 Supervision status</i> .	28
	Supervision 6	Bit 5 of <i>32.01 Supervision status</i> .	29
	EFB MCW bit 3	Control word bit 3 received through the embedded fieldbus interface.	32
	<i>Other [bit]</i>	Source selection (see <i>Terms and abbreviations</i>).	-
20.19	<i>Enable start command</i>	Selects the source for the start enable signal. 1 = Start enable. With the signal switched off, any drive start command is inhibited. (Switching the signal off while the drive is running will not stop the drive.) See also parameter <i>20.12 Run enable 1 source</i> .	<i>On</i>
	Off	0.	0
	On	1.	1
	DI1	Digital input DI1 (<i>10.02 DI delayed status</i> , bit 0).	2
	DI2	Digital input DI2 (<i>10.02 DI delayed status</i> , bit 1).	3
	DI3	Digital input DI3 (<i>10.02 DI delayed status</i> , bit 2).	4
	DI4	Digital input DI4 (<i>10.02 DI delayed status</i> , bit 3).	5
	DI5	Digital input DI5 (<i>10.02 DI delayed status</i> , bit 4).	6
	Supervision 1	Bit 0 of <i>32.01 Supervision status</i> .	24
	Supervision 2	Bit 1 of <i>32.01 Supervision status</i> .	25
	Supervision 3	Bit 2 of <i>32.01 Supervision status</i> .	26
	Supervision 4	Bit 3 of <i>32.01 Supervision status</i> .	27
	Supervision 5	Bit 4 of <i>32.01 Supervision status</i> .	28
	Supervision 6	Bit 5 of <i>32.01 Supervision status</i> .	29
	<i>Other [bit]</i>	Source selection (see <i>Terms and abbreviations</i>).	-

154 Parameters

No.	Name/Value	Description	Default FbEq 16																
20.21	<i>Direction</i>	Reference direction lock. Defines the direction of the drive rather than the sign of the reference, except in some cases. In the table the actual drive rotation is shown as a function of parameter <i>20.21 Direction</i> and Direction command (from parameter <i>20.01 Ext2 commands</i> or <i>20.06 Ext2 commands</i>).	<i>Request</i>																
		<table border="1"> <thead> <tr> <th></th> <th>Direction command = Forward</th> <th>Direction command = Reverse</th> <th>Direction command not defined</th> </tr> </thead> <tbody> <tr> <td>Par. <i>20.21 Direction</i> = Forward</td> <td>Forward</td> <td>Forward</td> <td>Forward</td> </tr> <tr> <td>Par. <i>20.21 Direction</i> = Reverse</td> <td>Reverse</td> <td>Reverse</td> <td>Reverse</td> </tr> <tr> <td>Par. <i>20.21 Direction</i> = Request</td> <td>Forward, but <ul style="list-style-type: none"> If reference from Constant, Motor potentiometer, PID, Safe speed, Last, Jogging or Panel reference, reference used as is. If reference from the network, reference used as is. </td> <td>Reverse, but <ul style="list-style-type: none"> If reference from Constant, PID or Jogging reference, reference used as is. If reference from the network, Panel, Analog input, Motor potentiometer, Safe speed or Last reference, reference multiplied by -1. </td> <td>Forward</td> </tr> </tbody> </table>		Direction command = Forward	Direction command = Reverse	Direction command not defined	Par. <i>20.21 Direction</i> = Forward	Forward	Forward	Forward	Par. <i>20.21 Direction</i> = Reverse	Reverse	Reverse	Reverse	Par. <i>20.21 Direction</i> = Request	Forward, but <ul style="list-style-type: none"> If reference from Constant, Motor potentiometer, PID, Safe speed, Last, Jogging or Panel reference, reference used as is. If reference from the network, reference used as is. 	Reverse, but <ul style="list-style-type: none"> If reference from Constant, PID or Jogging reference, reference used as is. If reference from the network, Panel, Analog input, Motor potentiometer, Safe speed or Last reference, reference multiplied by -1. 	Forward	
	Direction command = Forward	Direction command = Reverse	Direction command not defined																
Par. <i>20.21 Direction</i> = Forward	Forward	Forward	Forward																
Par. <i>20.21 Direction</i> = Reverse	Reverse	Reverse	Reverse																
Par. <i>20.21 Direction</i> = Request	Forward, but <ul style="list-style-type: none"> If reference from Constant, Motor potentiometer, PID, Safe speed, Last, Jogging or Panel reference, reference used as is. If reference from the network, reference used as is. 	Reverse, but <ul style="list-style-type: none"> If reference from Constant, PID or Jogging reference, reference used as is. If reference from the network, Panel, Analog input, Motor potentiometer, Safe speed or Last reference, reference multiplied by -1. 	Forward																
	Request	In external control the direction is selected by a direction command (parameter <i>20.01 Ext2 commands</i> or <i>20.06 Ext2 commands</i>). If the reference comes from Constant (constant speeds/frequencies), Motor potentiometer, PID, Fail, Last (last speed reference), Jogging (jogging speed) or Panel reference, the reference is used as is. If the reference comes from a fieldbus: <ul style="list-style-type: none"> if the direction command is forward, the reference is used as is if the direction command is reverse, the reference is multiplied by -1. 	0																
	Forward	Motor rotates forward regardless of the sign of the external reference. (Negative reference values are replaced by zero. Positive reference values are used as is.)	1																
	Reverse	Motor rotates reverse regardless of the sign of the external reference. (Negative reference values are replaced by zero. Positive reference values are multiplied by -1.)	2																

No.	Name/Value	Description	Default FbEq 16
20.22	<i>Enable to rotate</i>	<p>Setting this parameter to 0 stops motor rotating but does not affect any other conditions for rotating. Setting the parameter back to 1 starts motor rotating again.</p> <p>This parameter can be used for example with a signal from some external equipment to prevent the motor rotating before the equipment is ready.</p> <p>When this parameter is 0 (rotating of the motor is disabled), bit 13 of parameter <i>06.16 Drive status word 1</i> is set to 0.</p>	<i>Selected</i>
	Not selected	0 (always off).	0
	Selected	1 (always on).	1
	DI1	Digital input DI1 (<i>10.02 DI delayed status</i> , bit 0).	2
	DI2	Digital input DI2 (<i>10.02 DI delayed status</i> , bit 1).	3
	DI3	Digital input DI3 (<i>10.02 DI delayed status</i> , bit 2).	4
	DI4	Digital input DI4 (<i>10.02 DI delayed status</i> , bit 3).	5
	DI5	Digital input DI5 (<i>10.02 DI delayed status</i> , bit 4).	6
	Supervision 1	Bit 0 of <i>32.01 Supervision status</i> .	24
	Supervision 2	Bit 1 of <i>32.01 Supervision status</i> .	25
	Supervision 3	Bit 2 of <i>32.01 Supervision status</i> .	26
	Supervision 4	Bit 3 of <i>32.01 Supervision status</i> .	27
	Supervision 5	Bit 4 of <i>32.01 Supervision status</i> .	28
	Supervision 6	Bit 5 of <i>32.01 Supervision status</i> .	29
	<i>Other [bit]</i>	Source selection (see <i>Terms and abbreviations</i>).	-
20.25	<i>Jogging enable</i>	<p>Selects the source for a jog enable signal.</p> <p>(The sources for jogging activation signals are selected by parameters <i>20.26 Jogging 1 start source</i> and <i>20.27 Jogging 2 start source</i>.)</p> <p>1 = Jogging is enabled. 0 = Jogging is disabled.</p> <p>Notes:</p> <ul style="list-style-type: none"> • Jogging is supported in vector control mode only. • Jogging can be enabled only when no start command from an external control location is active. On the other hand, if jogging is already enabled, the drive cannot be started from an external control location (apart from inching commands through fieldbus). <p>See section <i>Rush control</i> on page 63.</p>	<i>Not selected</i>
	Not selected	0.	0
	Selected	1.	1
	DI1	Digital input DI1 (<i>10.02 DI delayed status</i> , bit 0).	2
	DI2	Digital input DI2 (<i>10.02 DI delayed status</i> , bit 1).	3
	DI3	Digital input DI3 (<i>10.02 DI delayed status</i> , bit 2).	4
	DI4	Digital input DI4 (<i>10.02 DI delayed status</i> , bit 3).	5
	DI5	Digital input DI5 (<i>10.02 DI delayed status</i> , bit 4).	6
	Supervision 1	Bit 0 of <i>32.01 Supervision status</i> .	24

No.	Name/Value	Description	Default FbEq 16
	Supervision 2	Bit 1 of <i>32.01 Supervision status</i> .	25
	Supervision 3	Bit 2 of <i>32.01 Supervision status</i> .	26
	Supervision 4	Bit 3 of <i>32.01 Supervision status</i> .	27
	Supervision 5	Bit 4 of <i>32.01 Supervision status</i> .	28
	Supervision 6	Bit 5 of <i>32.01 Supervision status</i> .	29
	<i>Other [bit]</i>	Source selection (see <i>Terms and abbreviations</i>).	-
20.26	<i>Jogging 1 start source</i>	<p>If enabled by parameter <i>20.25 Jogging enable</i>, selects the source for the activation of jogging function 1. (Jogging function 1 can also be activated through fieldbus regardless of parameter <i>20.25</i>.) 1 = Jogging 1 active.</p> <p>Notes:</p> <ul style="list-style-type: none"> • Jogging is supported in vector control mode only. • If both jogging 1 and 2 are activated, the one that was activated first has priority. • This parameter cannot be changed while the drive is running. 	<i>Not selected</i>
	Not selected	0.	0
	Selected	1.	1
	DI1	Digital input DI1 (<i>10.02 DI delayed status</i> , bit 0).	2
	DI2	Digital input DI2 (<i>10.02 DI delayed status</i> , bit 1).	3
	DI3	Digital input DI3 (<i>10.02 DI delayed status</i> , bit 2).	4
	DI4	Digital input DI4 (<i>10.02 DI delayed status</i> , bit 3).	5
	DI5	Digital input DI5 (<i>10.02 DI delayed status</i> , bit 4).	6
	Supervision 1	Bit 0 of <i>32.01 Supervision status</i> .	24
	Supervision 2	Bit 1 of <i>32.01 Supervision status</i> .	25
	Supervision 3	Bit 2 of <i>32.01 Supervision status</i> .	26
	Supervision 4	Bit 3 of <i>32.01 Supervision status</i> .	27
	Supervision 5	Bit 4 of <i>32.01 Supervision status</i> .	28
	Supervision 6	Bit 5 of <i>32.01 Supervision status</i> .	29
	<i>Other [bit]</i>	Source selection (see <i>Terms and abbreviations</i>).	-
20.27	<i>Jogging 2 start source</i>	<p>If enabled by parameter <i>20.25 Jogging enable</i>, selects the source for the activation of jogging function 2. (Jogging function 2 can also be activated through fieldbus regardless of parameter <i>20.25</i>.) 1 = Jogging 2 active.</p> <p>For the selections, see parameter <i>20.26 Jogging 1 start source</i>.</p> <p>Notes:</p> <ul style="list-style-type: none"> • Jogging is supported in vector control mode only. • If both jogging 1 and 2 are activated, the one that was activated first has priority. • This parameter cannot be changed while the drive is running. 	<i>Not selected</i>
20.28	<i>Remote to local action</i>	Select the action to take when the drive switches between remote and local control modes.	<i>Keep running</i>

No.	Name/Value	Description	Default FbEq 16												
	Keep running	The drive will continue to run when the user changes between the local and remote control of the drive. See <i>Local and external control locations</i> (page 46).	0												
	Stop	The drive will stop when the user changes between the local and remote control of the drive. See <i>Local and external control locations</i> (page 46).	1												
20.30	<i>Enable signals warning function</i>	Selects the enable signal warnings that will be suppressed. This parameter can be used to prevent these warnings from being added to the event log. Whenever a bit of this parameter is set to 1, the corresponding warning is suppressed.	0000h												
		<table border="1"> <thead> <tr> <th>Bit</th> <th>Name</th> <th>Description</th> </tr> </thead> <tbody> <tr> <td>0</td> <td>Enable to rotate</td> <td>1 = Warning <i>AFED Enable to rotate</i> is suppressed.</td> </tr> <tr> <td>1</td> <td>Run enable missing</td> <td>1 = Warning <i>AFEB Run enable missing</i> is suppressed.</td> </tr> <tr> <td>3...15</td> <td>Reserved</td> <td></td> </tr> </tbody> </table>	Bit	Name	Description	0	Enable to rotate	1 = Warning <i>AFED Enable to rotate</i> is suppressed.	1	Run enable missing	1 = Warning <i>AFEB Run enable missing</i> is suppressed.	3...15	Reserved		
Bit	Name	Description													
0	Enable to rotate	1 = Warning <i>AFED Enable to rotate</i> is suppressed.													
1	Run enable missing	1 = Warning <i>AFEB Run enable missing</i> is suppressed.													
3...15	Reserved														
	0000h...FFFFh	Word for disabling enable signal warnings.	1 = 1												
<i>21 Start/stop mode</i>		Start and stop modes; emergency stop mode and signal source selection; DC magnetization settings.													
21.01	<i>Start mode</i>	Selects the motor start function for the vector motor control mode, ie. when <i>99.04 Motor control mode</i> is set to <i>Vector</i> . Notes: <ul style="list-style-type: none"> The start function for the scalar motor control mode is selected by parameter <i>21.19 Scalar start mode</i>. Starting into a rotating motor is not possible when DC magnetizing is selected (<i>Fast</i> or <i>Const time</i>). With permanent magnet motors, <i>Automatic</i> start mode must be used. This parameter cannot be changed while the drive is running. See also section <i>DC magnetization</i> on page 71.	<i>Const time</i>												
	Fast	The drive pre-magnetizes the motor before start. The pre-magnetizing time is determined automatically, typically 200 ms to 2 s depending on motor size. Select this mode if a high break-away torque is required.	0												

No.	Name/Value	Description	Default FbEq 16										
	Const time	<p>The drive pre-magnetizes the motor before start. The pre-magnetizing time is defined by parameter <i>21.02 Magnetization time</i>. This mode should be selected if constant pre-magnetizing time is required (e.g. if the motor start must be synchronized with the release of a mechanical brake). This setting also guarantees the highest possible break-away torque when the pre-magnetizing time is set long enough.</p> <p> WARNING! The drive will start after the set magnetizing time has passed even if motor magnetization is not completed. In applications where a full break-away torque is essential, ensure that the constant magnetizing time is long enough to allow generation of full magnetization and torque.</p>	1										
	Automatic	<p>Automatic start guarantees optimal motor start in most cases. It includes the flying start function (starting into a rotating motor) and the automatic restart function. The drive motor control program identifies the flux as well as the mechanical state of the motor and starts the motor instantly under all conditions.</p> <p>Note: If parameter <i>99.04 Motor control mode</i> is set to <i>Scalar</i>, no flying start or automatic restart is possible unless parameter <i>21.19 Scalar start mode</i> is set to <i>Automatic</i>.</p>	2										
21.02	<i>Magnetization time</i>	<p>Defines the pre-magnetization time when</p> <ul style="list-style-type: none"> parameter <i>21.01 Start mode</i> is set to <i>Const time</i> (in vector motor control mode), or parameter <i>21.19 Scalar start mode</i> is set to <i>Const time</i> (in scalar motor control mode). <p>After the start command, the drive automatically premagnetizes the motor for the set time. To ensure full magnetizing, set this parameter to the same value as, or higher than, the rotor time constant. If not known, use the rule-of-thumb value given in the table below:</p> <table border="1" data-bbox="372 1038 846 1214"> <thead> <tr> <th>Motor rated power</th> <th>Constant magnetizing time</th> </tr> </thead> <tbody> <tr> <td>< 1 kW</td> <td>≥ 50 to 100 ms</td> </tr> <tr> <td>1 to 10 kW</td> <td>≥ 100 to 200 ms</td> </tr> <tr> <td>10 to 200 kW</td> <td>≥ 200 to 1000 ms</td> </tr> <tr> <td>200 to 1000 kW</td> <td>≥ 1000 to 2000 ms</td> </tr> </tbody> </table> <p>Note: This parameter cannot be changed while the drive is running.</p>	Motor rated power	Constant magnetizing time	< 1 kW	≥ 50 to 100 ms	1 to 10 kW	≥ 100 to 200 ms	10 to 200 kW	≥ 200 to 1000 ms	200 to 1000 kW	≥ 1000 to 2000 ms	500 ms
Motor rated power	Constant magnetizing time												
< 1 kW	≥ 50 to 100 ms												
1 to 10 kW	≥ 100 to 200 ms												
10 to 200 kW	≥ 200 to 1000 ms												
200 to 1000 kW	≥ 1000 to 2000 ms												
	0...10000 ms	Constant DC magnetizing time.	1 = 1 ms										

No.	Name/Value	Description	Default FbEq 16
21.03	<i>Stop mode</i>	Selects the way the motor is stopped when a stop command is received. Additional braking is possible by selecting flux braking (see parameter <i>97.05 Flux braking</i>).	Ramp
	Coast	Stop by switching off the output semiconductors of the drive. The motor coasts to a stop.  WARNING! If a mechanical brake is used, make sure it is safe to stop the drive by coasting.	0
	Ramp	Stop along the active deceleration ramp. See parameter group <i>23 Speed reference ramp</i> or <i>28 Frequency reference chain</i> .	1
	Torque limit	Stop according to torque limits (parameters <i>30.19</i> and <i>30.20</i>). This mode is only possible in vector motor control mode.	2
21.04	<i>Emergency stop mode</i>	Selects the way the motor is stopped when an emergency stop command is received. The source of the emergency stop signal is selected by parameter <i>21.05 Emergency stop source</i> .	<i>Ramp stop (Off1)</i>
	Ramp stop (Off1)	With the drive running: <ul style="list-style-type: none"> • 1 = Normal operation. • 0 = Normal stop along the standard deceleration ramp defined for the particular reference type (see section <i>Reference ramping</i> on page 57). After the drive has stopped, it can be restarted by removing the emergency stop signal and switching the start signal from 0 to 1. With the drive stopped: <ul style="list-style-type: none"> • 1 = Starting allowed. • 0 = Starting not allowed. 	0
	Coast stop (Off2)	With the drive running: <ul style="list-style-type: none"> • 1 = Normal operation. • 0 = Stop by coasting. With the drive stopped: <ul style="list-style-type: none"> • 1 = Starting allowed. • 0 = Starting not allowed. 	1
	Eme ramp stop (Off3)	With the drive running: <ul style="list-style-type: none"> • 1 = Normal operation • 0 = Stop by ramping along emergency stop ramp defined by parameter <i>23.23 Emergency stop time</i>. After the drive has stopped, it can be restarted by removing the emergency stop signal and switching the start signal from 0 to 1. With the drive stopped: <ul style="list-style-type: none"> • 1 = Starting allowed • 0 = Starting not allowed 	2
21.05	<i>Emergency stop source</i>	Selects the source of the emergency stop signal. The stop mode is selected by parameter <i>21.04 Emergency stop mode</i> . 0 = Emergency stop active 1 = Normal operation Note: This parameter cannot be changed while the drive is running.	<i>Inactive (true)</i>
	Active (false)	0.	0
	Inactive (true)	1.	1

160 Parameters

No.	Name/Value	Description	Default FbEq 16
	DI1	Digital input DI1 (<i>10.02 DI delayed status</i> , bit 0).	3
	DI2	Digital input DI2 (<i>10.02 DI delayed status</i> , bit 1).	4
	DI3	Digital input DI3 (<i>10.02 DI delayed status</i> , bit 2).	5
	DI4	Digital input DI4 (<i>10.02 DI delayed status</i> , bit 3).	6
	DI5	Digital input DI5 (<i>10.02 DI delayed status</i> , bit 4).	7
<i>21.06</i>	<i>Zero speed limit</i>	Defines the zero speed limit. The motor is stopped along a speed ramp (when ramped stop is selected or emergency stop time is used) until the defined zero speed limit is reached. After the zero speed delay, the motor coasts to a stop.	30.00 rpm
	0.00...30000.00 rpm	Zero speed limit.	See par. <i>46.01</i>

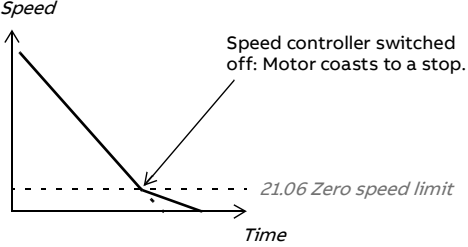
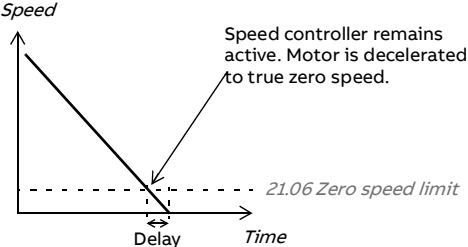
No.	Name/Value	Description	Default FbEq 16
21.07	<i>Zero speed delay</i>	<p>Defines the delay for the zero speed delay function. The function is useful in applications where a smooth and quick restarting is essential. During the delay, the drive knows the rotor position accurately.</p> <p><u>Without zero speed delay:</u> The drive receives a stop command and decelerates along a ramp. When actual motor speed falls below the value of parameter <i>21.06 Zero speed limit</i>, inverter modulation is stopped and the motor coasts to a standstill.</p>  <p><u>With zero speed delay:</u> The drive receives a stop command and decelerates along a ramp. When actual motor speed falls below the value of parameter <i>21.06 Zero speed limit</i>, the zero speed delay function activates. During the delay the function keeps the speed controller live: the inverter modulates, motor is magnetized and the drive is ready for a quick restart. Zero speed delay can be used e.g. with the jogging function.</p> 	0 ms
	0...30000 ms	Zero speed delay.	1 = 1 ms

162 Parameters

No.	Name/Value	Description	Default FbEq 16															
21.08	<i>DC current control</i>	<p>Activates/deactivates the DC hold and post-magnetization functions. See section <i>DC magnetization</i> on page 71.</p> <p>Note: DC magnetization causes the motor to heat up. In applications where long DC magnetization times are required, externally ventilated motors should be used. If the DC magnetization period is long, DC magnetization cannot prevent the motor shaft from rotating if a constant load is applied to the motor.</p>	0b0000															
<table border="1"> <thead> <tr> <th>Bit</th> <th>Name</th> <th>Value</th> </tr> </thead> <tbody> <tr> <td>0</td> <td>DC hold</td> <td>1 = DC hold. See section <i>DC hold</i> on page 71. Note: The DC hold function has no effect if the start signal is switched off.</td> </tr> <tr> <td>1</td> <td>Post-magnetization</td> <td>1 = Post-magnetization. See section <i>Post-magnetization</i> on page 72. Note: Post-magnetization is only available when ramping is the selected stop mode (see parameter <i>21.03 Stop mode</i>).</td> </tr> <tr> <td>2</td> <td>DC brake</td> <td>1 = Enable DC brake.</td> </tr> <tr> <td>3...15</td> <td>Reserved</td> <td></td> </tr> </tbody> </table>				Bit	Name	Value	0	DC hold	1 = DC hold. See section <i>DC hold</i> on page 71. Note: The DC hold function has no effect if the start signal is switched off.	1	Post-magnetization	1 = Post-magnetization. See section <i>Post-magnetization</i> on page 72. Note: Post-magnetization is only available when ramping is the selected stop mode (see parameter <i>21.03 Stop mode</i>).	2	DC brake	1 = Enable DC brake.	3...15	Reserved	
Bit	Name	Value																
0	DC hold	1 = DC hold. See section <i>DC hold</i> on page 71. Note: The DC hold function has no effect if the start signal is switched off.																
1	Post-magnetization	1 = Post-magnetization. See section <i>Post-magnetization</i> on page 72. Note: Post-magnetization is only available when ramping is the selected stop mode (see parameter <i>21.03 Stop mode</i>).																
2	DC brake	1 = Enable DC brake.																
3...15	Reserved																	
	0b0000...0b1111	DC magnetization selection.	1 = 1															
21.09	<i>DC hold speed</i>	Defines the DC hold speed in speed control mode. See parameter <i>21.08 DC current control</i> , and section <i>DC hold</i> on page 71.	5.00 rpm															
	0.00...1000.00 rpm	DC hold speed.	See par. 46.01															
21.10	<i>DC current reference</i>	Defines the DC hold current in percent of the motor nominal current. See parameter <i>21.08 DC current control</i> , and section <i>DC magnetization</i> on page 71. After 100 s post-magnetization time, the maximum magnetization current is limited to the magnetization current corresponding to the actual flux reference.	30.0%															
	0.0...100.0%	DC hold current.	1 = 1%															
21.11	<i>Post magnetization time</i>	Defines the length of time for which post-magnetization is active after stopping the motor. The magnetization current is defined by parameter <i>21.10 DC current reference</i> . See parameter <i>21.08 DC current control</i>	0 s															
	0...3000 s	Post-magnetization time.	1 = 1 s															
21.13	<i>Autophasing mode</i>	Selects the way autophasing is performed during the ID run. See section <i>Autophasing</i> on page 66.	<i>Turning</i>															
	Turning	This mode gives the most accurate autophasing result. This mode can be used, and is recommended, if the motor is allowed to rotate during the ID run and the start-up is not time-critical.	0															
	Turning 2	It is like Turning autophasing mode with the difference that at the end of turning autophasing routine, rotor turns by 180 electrical degrees.	5															

No.	Name/Value	Description	Default FbEq 16
21.14	<i>Pre-heating input source</i>	Selects the source for triggering pre-heating for the motor. The status of the pre-heating is shown as bit 2 of <i>06.21 Drive status word 3</i> . Notes: <ul style="list-style-type: none"> The heating function requires that STO is not triggered. The heating function requires that the drive is not faulted. Pre-heating uses DC hold to produce current. 	<i>Off</i>
	Off	0. Pre-heating is always deactivated.	0
	On	1. Pre-heating is always activated when the drive is stopped.	1
	DI1	Digital input DI1 (<i>10.02 DI delayed status</i> , bit 0).	2
	DI2	Digital input DI2 (<i>10.02 DI delayed status</i> , bit 1).	3
	DI3	Digital input DI3 (<i>10.02 DI delayed status</i> , bit 2).	4
	DI4	Digital input DI4 (<i>10.02 DI delayed status</i> , bit 3).	5
	DI5	Digital input DI5 (<i>10.02 DI delayed status</i> , bit 4).	6
	Supervision 1	Bit 0 of <i>32.01 Supervision status</i> (see page 221).	8
	Supervision 2	Bit 1 of <i>32.01 Supervision status</i> (see page 221).	9
	Supervision 3	Bit 2 of <i>32.01 Supervision status</i> (see page 221).	10
	<i>Other [bit]</i>	Source selection (see <i>Terms and abbreviations</i>).	-
21.15	<i>Pre-heating time delay</i>	Time delay before pre-heating starts after the drive is stopped.	60 s
	10...3000 s	Pre-heating time delay.	1 = 1 s
21.16	<i>Pre-heating current</i>	Defines the DC current used to heat the motor. The value is in percent of the nominal motor current.	0.0%
	0.0...30.0%	Pre-heating current.	1 = 1%
21.19	<i>Scalar start mode</i>	Selects the motor start function for the scalar motor control mode, ie. when <i>99.04 Motor control mode</i> is set to <i>Scalar</i> . Notes: <ul style="list-style-type: none"> The start function for the vector motor control mode is selected by parameter <i>21.01 Start mode</i>. With permanent magnet motors, <i>Automatic</i> start mode must be used. This parameter cannot be changed while the drive is running. See also section <i>DC magnetization</i> on page 71.	<i>Const time</i>
	Normal	Immediate start from zero speed.	0

No.	Name/Value	Description	Default FbEq 16
	Const time	<p>The drive pre-magnetizes the motor before start. The pre-magnetizing time is defined by parameter <i>21.02 Magnetization time</i>. This mode should be selected if constant pre-magnetizing time is required (e.g. if the motor start must be synchronized with the release of a mechanical brake). This setting also guarantees the highest possible break-away torque when the pre-magnetizing time is set long enough.</p> <p>Note: This mode cannot be used to start into a rotating motor.</p> <p> WARNING! The drive will start after the set magnetizing time has passed even if motor magnetization is not completed. In applications where a full break-away torque is essential, ensure that the constant magnetizing time is long enough to allow generation of full magnetization and torque.</p>	1
	Automatic	<p>The drive automatically selects the correct output frequency to start a rotating motor. This is useful for flying starts: if the motor is already rotating, the drive will start smoothly at the current frequency.</p> <p>Note: Cannot be used in multimotor systems.</p>	2
	Torque boost	<p>Torque boost is applied at start, ending when output frequency exceeds 40% of nominal frequency or when output frequency is equal to reference.</p>	3
	Automatic + boost	<p>If the Flystart routine does not detect rotating motor, torque boost is applied.</p>	4
	Flying start	<p>The drive automatically selects the correct output frequency to start a rotating motor. If the motor is already rotating, drive will start smoothly at the current frequency. The mode will start the motor with vector control and switch to scalar control on the fly when the motor speed has been found. Compared to the Automatic start mode, Flying start detects the motor speed faster. Flying start requires more accurate information about motor model. Therefore standstill ID run is done automatically when the drive is started for the first time after selecting Flying start. Motor plate values should be accurate. Wrong plate values may decrease the starting performance.</p> <p>Note: Flying start cannot be used in multimotor systems.</p> <p>Note: During flying start, the drive will at first run in vector control mode. This is why, when using flying start, the drive nominal current setting must be in the allowed range for vector control mode. See parameter <i>99.06</i>.</p>	5
	Flying start + boost	<p>Flying start with torque boost.</p> <p>Flying start is performed first and the motor is magnetized. If the speed is found to be zero, torque boost is applied.</p>	6

No.	Name/Value	Description	Default FbEq 16
21.21	<i>DC hold frequency</i>	Defines the DC hold frequency, which is used instead of parameter <i>21.09 DC hold speed</i> when the operating mode in use is <i>Scalar frequency mode</i> . See parameters <i>19.01 Actual operation mode</i> , <i>21.08 DC current control</i> , and section <i>DC hold</i> on page 71.	5.00 Hz
	0.00...1000.00 Hz	DC hold frequency.	1 = 1 Hz
21.22	<i>Start delay</i>	Defines the start delay. After the conditions for start have been fulfilled, the drive waits until the delay has elapsed and then starts the motor. During the delay, warning <i>AFE9 Start delay</i> is shown. Start delay can be used with all start modes.	0.00 s
	0.00...60.00 s	Start delay	1 = 1 s
21.23	<i>Smooth start</i>	Enables smooth start function. Smooth start function restricts the motor current below the limit defined by parameter <i>21.24 Smooth start current</i> when the motor speed is below <i>21.25 Smooth start speed</i> . Warning: Long run operation of smooth start at low speed with high current may heat the motor.	<i>Disabled</i>
	Disabled	Smooth start disabled	0
	Enabled always	Smooth start function is always active when speed is below limit.	1
	Start only	Smooth start function is only active after start while the speed is below limit.	2
21.24	<i>Smooth start current</i>	Current applied to motor when the smooth start is active.	50.0%
	10.0... 100.0%	Value in percent of the motor nominal current.	1=1%
21.25	<i>Smooth start speed</i>	Set the smooth start speed when the current is applied.	10.0%
	2.0... 100.0%	Value in percent of the motor nominal speed.	1=1%
21.26	<i>Torque boost current</i>	Defines the maximum supplied current to motor during 'Torque boost' –starting mode. Parameter value is in percent of the motor nominal current. Nominal value of the parameter is 100.0%. 'Torque boost' –starting mode can be used only when motor control mode is 'Scalar'. Torque boost is only applied at start, ending when output frequency exceeds 40% of nominal frequency or when output frequency is equal to reference.	100.0%
	15.0... 300.0%		0.01 = 1%
21.27	<i>Torque boost time</i>	Defines the minimum and maximum torque boost time. If torque boost time is less than 40% of frequency acceleration time (see parameters <i>28.72</i> and <i>28.74</i>), torque boost time is set at 40% of the frequency acceleration time.	20.0 s
	0.0... 60.0s	Nominal motor time.	1=1s



No.	Name/Value	Description	Default FbEq 16
21.30	<i>Speed compensated stop mode</i>	Selects the method used to stop the drive. See also section <i>Speed compensated stop</i> on page 74. Speed compensated stop is active only if <ul style="list-style-type: none"> the operation mode is not torque, and parameter 21.03 <i>Stop mode</i> is <i>Ramp</i>, or parameter 20.11 <i>Run enable stop mode</i> is <i>Ramp</i> (in case Run enable is missing). 	<i>Off</i>
	Off	Stop according parameter 21.03 <i>Stop mode</i> , no speed compensated stop.	0
	Speed comp FWD	If the direction of rotation is forward, speed compensation is used for constant distance braking. Speed difference (between used speed and maximum speed) is compensated by running the drive with current speed before the motor is stopped along a ramp. If the direction of rotation is reverse, the drive is stopped along a ramp.	1
	Speed comp REV	If the direction of rotation is reverse, speed compensation is used for constant distance braking. Speed difference (between used speed and maximum speed) is compensated by running the drive with current speed before the motor is stopped along a ramp. If the direction of rotation is forward, the drive is stopped along a ramp.	2
	Speed comp bipolar	Regardless of the direction of rotation, speed compensation is used for constant distance braking. Speed difference (between used speed and maximum speed) is compensated by running the drive with current speed before the motor is stopped along a ramp.	3
21.31	<i>Speed comp stop delay</i>	This delay adds distance to the total distance traveled during a stop from maximum speed. It is used to adjust the distance to match requirements so that the distance traveled is not solely determined by the deceleration rate.	0.00 s
	0.00...1000.00 s	Speed delay.	1 = 1 s
21.32	<i>Speed comp stop threshold</i>	This parameter sets a speed threshold below which the Speed compensated stop feature is disabled. In this speed region, the speed compensated stop is not attempted and the drive stops as it would, using the ramp option.	10%
	0...100%	Speed threshold as a percent of the motor nominal speed.	1 = 1%
<i>22 Speed reference selection</i>		Speed reference selection; motor potentiometer settings. See the control chain diagrams on pages 408...412.	
22.01	<i>Speed ref unlimited</i>	Displays the output of the speed reference selection block. See the control chain diagram on page 408. This parameter is read-only.	0.00 rpm
	-30000.00... 30000.00 rpm	Value of the selected speed reference.	See par. 46.01

No.	Name/Value	Description	Default FbEq 16
22.11	Ext1 speed ref1	<p>Selects Ext1 speed reference source 1.</p> <p>Two signal sources can be defined by this parameter and 22.12 Ext1 speed ref2. A mathematical function (22.13 Ext1 speed function) applied to the two signals creates an Ext1 reference (A in the figure below).</p> <p>A digital source selected by 19.11 Ext1/Ext2 selection can be used to switch between Ext1 reference and the corresponding Ext2 reference defined by parameters 22.18 Ext2 speed ref1, 22.19 Ext2 speed ref2 and 22.20 Ext2 speed function (B in the figure below).</p> <p>Note: The default value depends on the selected macro. See <i>Control macros</i> on page 27.</p>	All scaled
<p>The diagram illustrates the signal processing for speed references. On the left, four input blocks (22.11, 22.12, 22.18, 22.19) each receive signals from '0', 'AI', 'FB', and 'Other'. The outputs of 22.11 and 22.12 are fed into block 22.13, which contains a 'Ref1' selector and five mathematical function blocks (ADD, SUB, MUL, MIN, MAX). The outputs of 22.18 and 22.19 are fed into block 22.20, which contains a 'Ref1' selector and the same five mathematical function blocks. The outputs of 22.13 and 22.20 are labeled 'Ext1' (A) and 'Ext2' (B) respectively. A selection block 19.11, with inputs '0' and '1', chooses between 'Ext1' and 'Ext2'. The final output is block 22.86, which is an arrow pointing right.</p>			
Zero	None.	0	
AI1 scaled	12.12 AI1 scaled value.	1	
AI2 scaled	12.22 AI2 scaled value.	2	
EFB ref1	03.09 EFB reference 1.	8	
EFB ref2	03.10 EFB reference 2.	9	
Motor potentiometer	22.80 Motor potentiometer ref act (output of the motor potentiometer).	15	
PID	40.01 Process PID output actual (output of the process PID controller).	16	

No.	Name/Value	Description	Default FbEq 16
	Frequency input 1	11.38 <i>Freq in 1 actual value</i> (when DI3 or DI4 is used as a frequency input).	17
	Control panel (ref saved)	<p>Panel reference (03.01 <i>Panel reference</i>, see page 114) saved by the control system for the location where the control returns is used as the reference.</p> <p><i>Reference</i></p> <ul style="list-style-type: none"> ● Ext1 reference × Ext2 reference — Active reference · · Inactive reference 	18
	Control panel (ref copied)	<p>Panel reference (03.01 <i>Panel reference</i> for the previous control location is used as the reference when the control location changes if the references for the two locations are of the same type (eg frequency/speed/torque/PID); otherwise, the actual signal is used as the new reference.</p> <p><i>Reference</i></p> <ul style="list-style-type: none"> ● Ext1 reference × Ext2 reference — Active reference · · Inactive reference 	19
	Integrated panel (ref saved)	See above Control panel (ref saved).	20
	Integrated panel (ref copied)	See above Control panel (ref copied).	21
	Frequency input 2	11.46 <i>Freq in 2 actual value</i> (when DI3 or DI4 is used as a frequency input).	22
	<i>Other</i>	Source selection (see <i>Terms and abbreviations</i>).	-
22.12	<i>Ext1 speed ref2</i>	Selects Ext1 speed reference source 2. For the diagram of reference source selection, see parameter 22.11 <i>Ext1 speed ref1</i> .	<i>Zero</i>
	Zero	None.	0
	AI1 scaled	12.12 <i>AI1 scaled value</i> .	1
	AI2 scaled	12.22 <i>AI2 scaled value</i> .	2
	EFB ref1	03.09 <i>EFB reference 1</i> .	8
	EFB ref2	03.10 <i>EFB reference 2</i> .	9
	Motor potentiometer	22.80 <i>Motor potentiometer ref act</i> (output of the motor potentiometer).	15
	PID	40.01 <i>Process PID output actual</i> (output of the process PID controller).	16
	Frequency input 1	11.38 <i>Freq in 1 actual value</i> (when DI3 or DI4 is used as a frequency input).	17

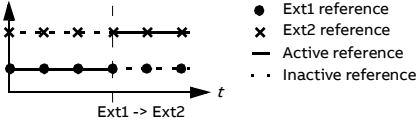
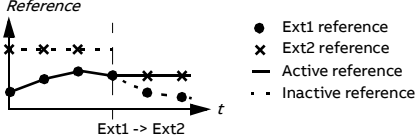
No.	Name/Value	Description	Default FbEq 16
	Control panel (ref saved)	<p>Panel reference (<i>03.01 Panel reference</i>, see page 114) saved by the control system for the location where the control returns is used as the reference.</p> <p><i>Reference</i></p> <p>● Ext1 reference x Ext2 reference — Active reference - - Inactive reference</p>	18
	Control panel (ref copied)	<p>Panel reference (<i>03.01 Panel reference</i>) for the previous control location is used as the reference when the control location changes if the references for the two locations are of the same type (eg frequency/speed/torque/PID); otherwise, the actual signal is used as the new reference.</p> <p><i>Reference</i></p> <p>● Ext1 reference x Ext2 reference — Active reference - - Inactive reference</p>	19
	Integrated panel (ref saved)	See above Control panel (ref saved).	20
	Integrated panel (ref copied)	See above Control panel (ref copied).	21
	Frequency input 2	<i>11.46 Freq in 2 actual value</i> (when DI3 or DI4 is used as a frequency input).	22
	<i>Other</i>	Source selection (see <i>Terms and abbreviations</i>).	-
<i>22.13</i>	<i>Ext1 speed function</i>	Selects a mathematical function between the reference sources selected by parameters <i>22.11 Ext1 speed ref1</i> and <i>22.12 Ext1 speed ref2</i> . See diagram at <i>22.11 Ext1 speed ref1</i> .	<i>Ref1</i>
	Ref1	Signal selected by <i>22.11 Ext1 speed ref1</i> is used as speed reference 1 as such (no function applied).	0
	Add (ref1 + ref2)	The sum of the reference sources is used as speed reference 1.	1
	Sub (ref1 - ref2)	The subtraction ($[22.11 \text{ Ext1 speed ref1}] - [22.12 \text{ Ext1 speed ref2}]$) of the reference sources is used as speed reference 1.	2
	Mul (ref1 × ref2)	The multiplication of the reference sources is used as speed reference 1.	3
	Min (ref1, ref2)	The smaller of the reference sources is used as speed reference 1.	4
	Max (ref1, ref2)	The greater of the reference sources is used as speed reference 1.	5

No.	Name/Value	Description	Default FbEq 16
22.18	Ext2 speed ref1	Selects Ext2 speed reference source 1. Two signal sources can be defined by this parameter and 22.19 Ext2 speed ref2. A mathematical function (22.20 Ext2 speed function) applied to the two signals creates an Ext2 reference. See diagram at 28.11 Ext1 frequency ref1.	Zero
	Zero	None.	0
	AI1 scaled	12.12 AI1 scaled value.	1
	AI2 scaled	12.22 AI2 scaled value.	2
	EFB ref1	03.09 EFB reference 1.	8
	EFB ref2	03.10 EFB reference 2.	9
	Motor potentiometer	22.19 Motor potentiometer ref act (output of the motor potentiometer).	15
	PID	40.01 Process PID output actual (output of the process PID controller).	16
	Frequency input 1	11.38 Freq in 1 actual value (when DI3 or DI4 is used as a frequency input).	17
	Control panel (ref saved)	Panel reference (03.01 Panel reference, see page 114) saved by the control system for the location where the control returns is used as the reference. Reference 	18
	Control panel (ref copied)	Panel reference (03.01 Panel reference, see page 114) for the previous control location is used as the reference when the control location changes if the references for the two locations are of the same type (eg frequency/speed/torque/PID); otherwise, the actual signal is used as the new reference. Reference 	19
	Integrated panel (ref saved)	See above Control panel (ref saved).	20
	Integrated panel (ref copied)	See above Control panel (ref copied).	21
	Frequency input 2	11.46 Freq in 2 actual value (when DI3 or DI4 is used as a frequency input).	22
	Other	Source selection (see Terms and abbreviations).	-
22.19	Ext2 speed ref2	Selects Ext2 speed reference source 2. For the selections, and a diagram of reference source selection, see parameter 22.18 Ext2 speed ref1.	Zero

No.	Name/Value	Description	Default FbEq 16															
22.20	<i>Ext2 speed function</i>	Selects a mathematical function between the reference sources selected by parameters 22.18 <i>Ext2 speed ref1</i> and 22.19 <i>Ext2 speed ref2</i> . See diagram at 22.18 <i>Ext2 speed ref1</i> .	<i>Ref1</i>															
	Ref1	Signal selected by <i>Ext2 speed ref1</i> is used as speed reference 1 as such (no function applied).	0															
	Add (ref1 + ref2)	The sum of the reference sources is used as speed reference 1.	1															
	Sub (ref1 - ref2)	The subtraction ([22.11 <i>Ext1 speed ref1</i>] - [22.12 <i>Ext1 speed ref2</i>]) of the reference sources is used as speed reference 1.	2															
	Mul (ref1 × ref2)	The multiplication of the reference sources is used as speed reference 1.	3															
	Min (ref1, ref2)	The smaller of the reference sources is used as speed reference 1.	4															
	Max (ref1, ref2)	The greater of the reference sources is used as speed reference 1.	5															
22.21	<i>Constant speed function</i>	Determines how constant speeds are selected, and whether the rotation direction signal is considered or not when applying a constant speed.	0b0001															
		<table border="1"> <thead> <tr> <th>Bit</th> <th>Name</th> <th>Information</th> </tr> </thead> <tbody> <tr> <td>0</td> <td>Constant speed mode</td> <td>1 = Packed: 7 constant speeds are selectable using the three sources defined by parameters 22.22, 22.23 and 22.24. 0 = Separate: Constant speeds 1, 2 and 3 are separately activated by the sources defined by parameters 22.22, 22.23 and 22.24 respectively. In case of conflict, the constant speed with the smaller number takes priority.</td> </tr> <tr> <td>1</td> <td>Direction enable</td> <td>1 = Start dir: To determine running direction for a constant speed, the sign of the constant speed setting (parameters 22.26...22.32) is multiplied by the direction signal (forward: +1, reverse: -1). This effectively allows the drive to have 14 (7 forward, 7 reverse) constant speeds if all values in 22.26...22.32 are positive.  WARNING! If the direction signal is reverse and the active constant speed is negative, the drive will run in the forward direction. 0 = According to Par: The running direction for the constant frequency is determined by the sign of the constant speed setting (parameters 28.26...28.32).</td> </tr> <tr> <td>2</td> <td>Speed step</td> <td>1 = Speed step enable; 0 = Speed step disable</td> </tr> <tr> <td>3...15</td> <td>Reserved</td> <td></td> </tr> </tbody> </table>	Bit	Name	Information	0	Constant speed mode	1 = Packed: 7 constant speeds are selectable using the three sources defined by parameters 22.22, 22.23 and 22.24. 0 = Separate: Constant speeds 1, 2 and 3 are separately activated by the sources defined by parameters 22.22, 22.23 and 22.24 respectively. In case of conflict, the constant speed with the smaller number takes priority.	1	Direction enable	1 = Start dir: To determine running direction for a constant speed, the sign of the constant speed setting (parameters 22.26...22.32) is multiplied by the direction signal (forward: +1, reverse: -1). This effectively allows the drive to have 14 (7 forward, 7 reverse) constant speeds if all values in 22.26...22.32 are positive.  WARNING! If the direction signal is reverse and the active constant speed is negative, the drive will run in the forward direction. 0 = According to Par: The running direction for the constant frequency is determined by the sign of the constant speed setting (parameters 28.26...28.32).	2	Speed step	1 = Speed step enable; 0 = Speed step disable	3...15	Reserved		
Bit	Name	Information																
0	Constant speed mode	1 = Packed: 7 constant speeds are selectable using the three sources defined by parameters 22.22, 22.23 and 22.24. 0 = Separate: Constant speeds 1, 2 and 3 are separately activated by the sources defined by parameters 22.22, 22.23 and 22.24 respectively. In case of conflict, the constant speed with the smaller number takes priority.																
1	Direction enable	1 = Start dir: To determine running direction for a constant speed, the sign of the constant speed setting (parameters 22.26...22.32) is multiplied by the direction signal (forward: +1, reverse: -1). This effectively allows the drive to have 14 (7 forward, 7 reverse) constant speeds if all values in 22.26...22.32 are positive.  WARNING! If the direction signal is reverse and the active constant speed is negative, the drive will run in the forward direction. 0 = According to Par: The running direction for the constant frequency is determined by the sign of the constant speed setting (parameters 28.26...28.32).																
2	Speed step	1 = Speed step enable; 0 = Speed step disable																
3...15	Reserved																	
	0b0000...0b1111	Constant speed configuration word.	1 = 1															

172 Parameters

No.	Name/Value	Description	Default FbEq 16																																				
22.22	<i>Constant speed sel1</i>	<p>When bit 0 of parameter <i>22.21 Constant speed function</i> is 0 (Separate), selects a source that activates constant speed 1.</p> <p>Note: The default value depends on the selected macro. See <i>Control macros</i> on page 27.</p> <p>When bit 0 of parameter <i>22.21 Constant speed function</i> is 1 (Packed), this parameter and parameters <i>22.23 Constant speed sel2</i> and <i>22.24 Constant speed sel3</i> select three sources whose states activate constant speeds as follows:</p>	<i>D13</i>																																				
<table border="1"> <thead> <tr> <th>Source defined by par. 22.22</th> <th>Source defined by par. 22.23</th> <th>Source defined by par. 22.24</th> <th>Constant speed active</th> </tr> </thead> <tbody> <tr> <td>0</td> <td>0</td> <td>0</td> <td>None</td> </tr> <tr> <td>1</td> <td>0</td> <td>0</td> <td>Constant speed 1</td> </tr> <tr> <td>0</td> <td>1</td> <td>0</td> <td>Constant speed 2</td> </tr> <tr> <td>1</td> <td>1</td> <td>0</td> <td>Constant speed 3</td> </tr> <tr> <td>0</td> <td>0</td> <td>1</td> <td>Constant speed 4</td> </tr> <tr> <td>1</td> <td>0</td> <td>1</td> <td>Constant speed 5</td> </tr> <tr> <td>0</td> <td>1</td> <td>1</td> <td>Constant speed 6</td> </tr> <tr> <td>1</td> <td>1</td> <td>1</td> <td>Constant speed 7</td> </tr> </tbody> </table>				Source defined by par. 22.22	Source defined by par. 22.23	Source defined by par. 22.24	Constant speed active	0	0	0	None	1	0	0	Constant speed 1	0	1	0	Constant speed 2	1	1	0	Constant speed 3	0	0	1	Constant speed 4	1	0	1	Constant speed 5	0	1	1	Constant speed 6	1	1	1	Constant speed 7
Source defined by par. 22.22	Source defined by par. 22.23	Source defined by par. 22.24	Constant speed active																																				
0	0	0	None																																				
1	0	0	Constant speed 1																																				
0	1	0	Constant speed 2																																				
1	1	0	Constant speed 3																																				
0	0	1	Constant speed 4																																				
1	0	1	Constant speed 5																																				
0	1	1	Constant speed 6																																				
1	1	1	Constant speed 7																																				
	Always off	0 (always off).	0																																				
	Always on	1 (always on).	1																																				
	DI1	Digital input DI1 (<i>10.02 DI delayed status</i> , bit 0).	2																																				
	DI2	Digital input DI2 (<i>10.02 DI delayed status</i> , bit 1).	3																																				
	DI3	Digital input DI3 (<i>10.02 DI delayed status</i> , bit 2).	4																																				
	DI4	Digital input DI4 (<i>10.02 DI delayed status</i> , bit 3).	5																																				
	DI5	Digital input DI5 (<i>10.02 DI delayed status</i> , bit 4).	6																																				
	Supervision 1	Bit 0 of <i>32.01 Supervision status</i> .	24																																				
	Supervision 2	Bit 1 of <i>32.01 Supervision status</i> .	25																																				
	Supervision 3	Bit 2 of <i>32.01 Supervision status</i> .	26																																				
	Supervision 4	Bit 3 of <i>32.01 Supervision status</i> .	27																																				
	Supervision 5	Bit 4 of <i>32.01 Supervision status</i> .	28																																				
	Supervision 6	Bit 5 of <i>32.01 Supervision status</i> .	29																																				
	<i>Other [bit]</i>	Source selection (see <i>Terms and abbreviations</i>).	-																																				
22.23	<i>Constant speed sel2</i>	<p>When bit 0 of parameter <i>22.21 Constant speed function</i> is 0 (Separate), selects a source that activates constant speed 2.</p> <p>When bit 0 of parameter <i>22.21 Constant speed function</i> is 1 (Packed), this parameter and parameters <i>22.22 Constant speed sel1</i> and <i>22.24 Constant speed sel3</i> select three sources that are used to activate constant speeds.</p> <p>For the selections, see parameter <i>22.22 Constant speed sel1</i>.</p> <p>Note: The default value depends on the selected macro. See <i>Control macros</i> on page 27.</p>	<i>D14</i>																																				

No.	Name/Value	Description	Default FbEq 16
22.24	<i>Constant speed sel3</i>	When bit 0 of parameter 22.21 <i>Constant speed function</i> is 0 (Separate), selects a source that activates constant speed 3. When bit 0 of parameter 22.21 <i>Constant speed function</i> is 1 (Packed), this parameter and parameters 22.22 <i>Constant speed sel1</i> and 22.23 <i>Constant speed sel2</i> select three sources that are used to activate constant speeds. See table at parameter 22.22 <i>Constant speed sel1</i> . For the selections, see parameter 22.22 <i>Constant speed sel1</i> .	<i>Always off</i>
22.26	<i>Constant speed 1</i>	Defines constant speed 1 (the speed the motor will turn when constant speed 1 is selected).	300.00 rpm
	-30000.00... 30000.00 rpm	Constant speed 1.	See par. 46.01
22.27	<i>Constant speed 2</i>	Defines constant speed 2.	600.00 rpm
	-30000.00... 30000.00 rpm	Constant speed 2.	See par. 46.01
22.28	<i>Constant speed 3</i>	Defines constant speed 3.	900.00 rpm
	-30000.00... 30000.00 rpm	Constant speed 3.	See par. 46.01
22.29	<i>Constant speed 4</i>	Defines constant speed 4.	1200.00 rpm
	-30000.00... 30000.00 rpm	Constant speed 4.	See par. 46.01
22.30	<i>Constant speed 5</i>	Defines constant speed 5.	1500.00 rpm
	-30000.00... 30000.00 rpm	Constant speed 5.	See par. 46.01
22.31	<i>Constant speed 6</i>	Defines constant speed 6.	2400.00 rpm
	-30000.00... 30000.00 rpm	Constant speed 6.	See par. 46.01
22.32	<i>Constant speed 7</i>	Defines constant speed 7.	3000.00 rpm
	-30000.00... 30000.00 rpm	Constant speed 7.	See par. 46.01
22.41	<i>Speed ref safe</i>	Defines a safe speed reference value that is used with supervision functions such as • 12.03 <i>AI supervision function</i> • 49.05 <i>Communication loss action</i>	0.00 rpm
	-30000.00... 30000.00 rpm	Safe speed reference.	See par. 46.01
22.42	<i>Jogging 1 ref</i>	Defines the speed reference for jogging function 1. For more information on jogging, see page 63.	0.00 rpm
	-30000.00... 30000.00 rpm	Speed reference for jogging function 1.	See par. 46.01
22.43	<i>Jogging 2 ref</i>	Defines the speed reference for jogging function 2. For more information on jogging, see page 63.	0.00 rpm
	-30000.00... 30000.00 rpm	Speed reference for jogging function 2.	See par. 46.01

No.	Name/Value	Description	Default FbEq 16												
22.51	<i>Critical speed function</i>	Enables/disables the critical speeds function. Also determines whether the specified ranges are effective in both rotating directions or not. See also section <i>Critical speeds/frequencies</i> on page 58.	0000h												
<table border="1"> <thead> <tr> <th>Bit</th> <th>Name</th> <th>Information</th> </tr> </thead> <tbody> <tr> <td>0</td> <td>Enable</td> <td>1 = Enable: Critical speeds enabled. 0 = Disable: Critical speeds disabled.</td> </tr> <tr> <td>1</td> <td>Sign mode</td> <td>1 = Signed: The signs of parameters 22.52... 22.57 are taken into account. 0 = Absolute: Parameters 22.52... 22.57 are handled as absolute values. Each range is effective in both directions of rotation.</td> </tr> <tr> <td>2...15</td> <td>Reserved</td> <td></td> </tr> </tbody> </table>				Bit	Name	Information	0	Enable	1 = Enable: Critical speeds enabled. 0 = Disable: Critical speeds disabled.	1	Sign mode	1 = Signed: The signs of parameters 22.52... 22.57 are taken into account. 0 = Absolute: Parameters 22.52... 22.57 are handled as absolute values. Each range is effective in both directions of rotation.	2...15	Reserved	
Bit	Name	Information													
0	Enable	1 = Enable: Critical speeds enabled. 0 = Disable: Critical speeds disabled.													
1	Sign mode	1 = Signed: The signs of parameters 22.52... 22.57 are taken into account. 0 = Absolute: Parameters 22.52... 22.57 are handled as absolute values. Each range is effective in both directions of rotation.													
2...15	Reserved														
	0000h...FFFFh	Critical speeds configuration word.	1 = 1												
22.52	<i>Critical speed 1 low</i>	Defines the low limit for critical speed range 1. Note: This value must be less than or equal to the value of 22.53 <i>Critical speed 1 high</i> .	0.00 rpm												
	-30000.00... 30000.00 rpm	Low limit for critical speed 1.	See par. 46.01												
22.53	<i>Critical speed 1 high</i>	Defines the high limit for critical speed range 1. Note: This value must be greater than or equal to the value of 22.52.	0.00 rpm												
	-30000.00... 30000.00 rpm	High limit for critical speed 1.	See par. 46.01												
22.54	<i>Critical speed 2 low</i>	Defines the low limit for critical speed range 2. Note: This value must be less than or equal to the value of parameter 22.55.	0.00 rpm												
	-30000.00... 30000.00 rpm	Low limit for critical speed 2.	See par. 46.01												
22.55	<i>Critical speed 2 high</i>	Defines the high limit for critical speed range 2. Note: This value must be greater than or equal to the value of parameter 22.54.	0.00 rpm												
	-30000.00... 30000.00 rpm	High limit for critical speed 2.	See par. 46.01												
22.56	<i>Critical speed 3 low</i>	Defines the low limit for critical speed range 3. Note: This value must be less than or equal to the value of parameter 22.57.	0.00 rpm												
	-30000.00... 30000.00 rpm	Low limit for critical speed 3.	See par. 46.01												
22.57	<i>Critical speed 3 high</i>	Defines the high limit for critical speed range 3. Note: This value must be greater than or equal to the value of parameter 22.56.	0.00 rpm												
	-30000.00... 30000.00 rpm	High limit for critical speed 3.	See par. 46.01												
22.70	<i>Motor potentiometer reference enable</i>	Determines when parameters 22.73 <i>Motor potentiometer up source</i> and 22.74 <i>Motor potentiometer down source</i> may change parameter 22.80 <i>Motor potentiometer ref act</i> .	<i>Selected</i>												

No.	Name/Value	Description	Default FbEq 16
	Not selected	Motor potentiometer Up/Down sources (22.73 and 22.74) are disabled.	0
	Selected	Motor potentiometer Up/Down sources (22.73 and 22.74) are enabled.	1
	While running	Motor potentiometer reference enable follows bit 4 (Following reference) of parameter 06.16 Drive status word 1.	2
22.71	Motor potentiometer function	Activates and selects the mode of the motor potentiometer. See section <i>Speed control performance figures</i> in chapter <i>Program features</i> .	Disabled
	Disabled	Motor potentiometer is disabled and its value set to 0.	0
	Enabled (init at stop/power-up)	When enabled, the motor potentiometer first adopts the value defined by parameter 22.72. The value can then be adjusted from the up and down sources defined by parameters 22.73 and 22.74. A power cycle will reset the motor potentiometer to the predefined initial value (22.72).	1
	Enabled (resume always)	As <i>Enabled (init at stop/power-up)</i> , but the motor potentiometer value is retained over a power cycle.	2
	Enabled (init to actual)	Whenever another reference source is selected, the value of the motor potentiometer follows that reference. After the source of reference returns to the motor potentiometer, its value can again be changed by the up and down sources (defined by 22.73 and 22.74).	3
	Enabled (resume/init to Actual)	As <i>Enabled (init to actual)</i> , but the motor potentiometer ref act value is retained over power cycle.	4
22.72	Motor potentiometer initial value	Defines an initial value (starting point) for the motor potentiometer. See the selections of parameter 22.71.	0.00
	-32768.00... 32767.00	Initial value for motor potentiometer.	1 = 1
22.73	Motor potentiometer up source	Selects the source of motor potentiometer up signal. 0 = No change 1 = Increase motor potentiometer value. (If both the up and down sources are on, the potentiometer value will not change.)	Not selected
	Not selected	0.	0
	Selected	1.	1
	DI1	Digital input DI1 (10.02 DI delayed status, bit 0).	2
	DI2	Digital input DI2 (10.02 DI delayed status, bit 1).	3
	DI3	Digital input DI3 (10.02 DI delayed status, bit 2).	4
	DI4	Digital input DI4 (10.02 DI delayed status, bit 3).	5
	DI5	Digital input DI5 (10.02 DI delayed status, bit 4).	6
	Supervision 1	Bit 0 of 32.01 Supervision status.	24
	Supervision 2	Bit 1 of 32.01 Supervision status.	25
	Supervision 3	Bit 2 of 32.01 Supervision status.	26

176 Parameters

No.	Name/Value	Description	Default FbEq 16
	Supervision 4	Bit 3 of <i>32.01 Supervision status</i> .	27
	Supervision 5	Bit 4 of <i>32.01 Supervision status</i> .	28
	Supervision 6	Bit 5 of <i>32.01 Supervision status</i> .	29
	<i>Other [bit]</i>	Source selection (see <i>Terms and abbreviations</i>).	-
22.74	<i>Motor potentiometer down source</i>	Selects the source of motor potentiometer down signal. 0 = No change 1 = Decrease motor potentiometer value. (If both the up and down sources are on, the potentiometer value will not change.) For the selections, see parameter <i>22.73</i> .	<i>Not selected</i>
22.75	<i>Motor potentiometer ramp time</i>	Defines the change rate of the motor potentiometer. This parameter specifies the time required for the motor potentiometer to change from minimum (parameter <i>22.76</i>) to maximum (parameter <i>22.77</i>). The same change rate applies in both directions.	400 s
	0.0...3600.0 s	Motor potentiometer change time.	1 = 1 s
22.76	<i>Motor potentiometer min value</i>	Defines the minimum value of the motor potentiometer. Note: If vector control mode is used, the value of this parameter must be changed.	-50.00
	-32768.00... 32767.00	Motor potentiometer minimum.	1 = 1
22.77	<i>Motor potentiometer max value</i>	Defines the maximum value of the motor potentiometer. Note: If vector control mode is used, the value of this parameter must be changed.	50.00
	-32768.00... 32767.00	Motor potentiometer maximum.	1 = 1
22.80	<i>Motor potentiometer ref act</i>	Shows the output of the motor potentiometer function. (The motor potentiometer is configured using parameters <i>22.71...22.74</i> .) This parameter is read-only.	-
	-32768.00... 32767.00	Value of motor potentiometer.	1 = 1
22.86	<i>Speed reference act 6</i>	Displays the value of the speed reference (Ext1 or Ext2) that has been selected by <i>19.11 Ext1/Ext2 selection</i> . See diagram at <i>22.11 Ext1 speed ref1</i> or the control chain diagram on page <i>408</i> . This parameter is read-only.	0.00 rpm
	-30000.00... 30000.00 rpm	Speed reference after additive 2.	See par. <i>46.01</i>

No.	Name/Value	Description	Default FbEq 16
22.87	<i>Speed reference act 7</i>	Displays the value of speed reference before application of critical speeds. See the control chain diagram on page 408. The value is received from 22.86 <i>Speed reference act 6</i> unless overridden by <ul style="list-style-type: none"> • any constant speed • a jogging reference • network control reference • control panel reference • safe speed reference. This parameter is read-only.	0.00 rpm
	-30000.00... 30000.00 rpm	Speed reference before application of critical speeds.	See par. 46.01
23 <i>Speed reference ramp</i>		Speed reference ramp settings (programming of the acceleration and deceleration rates for the drive). See the control chain diagram on page 410.	
23.01	<i>Speed ref ramp input</i>	Displays the used speed reference (in rpm) before it enters the ramping and shaping functions. See the control chain diagram on page 410. This parameter is read-only.	-
	-30000.00... 30000.00 rpm	Speed reference before ramping and shaping.	See par. 46.01
23.02	<i>Speed ref ramp output</i>	Displays the ramped and shaped speed reference in rpm. See the control chain diagram on page 410. This parameter is read-only.	-
	-30000.00... 30000.00 rpm	Speed reference after ramping and shaping.	See par. 46.01
23.11	<i>Ramp set selection</i>	Selects the source that switches between the two sets of acceleration/deceleration ramp times defined by parameters 23.12... 23.15 0 = Acceleration time 1, deceleration time 1 and shape time 1 are active. 1 = Acceleration time 2, deceleration time 2 and shape time 2 are active.	D11
	Acc/Dec time 1	0.	0
	Acc/Dec time 2	1.	1
	DI1	Digital input DI1 (10.02 <i>DI delayed status</i> , bit 0).	2
	DI2	Digital input DI2 (10.02 <i>DI delayed status</i> , bit 1).	3
	DI3	Digital input DI3 (10.02 <i>DI delayed status</i> , bit 2).	4
	DI4	Digital input DI4 (10.02 <i>DI delayed status</i> , bit 3).	5
	DI5	Digital input DI4 (10.02 <i>DI delayed status</i> , bit 4).	6
	EFB DCU CW bit 10	Only for the DCU profile. DCU control word bit 10 received through the embedded fieldbus interface.	20
	<i>Other [bit]</i>	Source selection (see <i>Terms and abbreviations</i>).	-

178 Parameters

No.	Name/Value	Description	Default FbEq 16
23.12	<i>Acceleration time 1</i>	<p>Defines acceleration time 1 as the time required for the speed to change from zero to the speed defined by parameter <i>46.01 Speed scaling</i> (not to parameter <i>30.12 Maximum speed</i>).</p> <p>If the speed reference increases faster than the set acceleration rate, the motor speed will follow the acceleration rate.</p> <p>If the speed reference increases slower than the set acceleration rate, the motor speed will follow the reference.</p> <p>If the acceleration time is set too short, the drive will automatically prolong the acceleration in order not to exceed the drive torque limits.</p>	3.000 s
	0.000 ...1800.000 s	Acceleration time 1.	10 = 1 s
23.13	<i>Deceleration time 1</i>	<p>Defines deceleration time 1 as the time required for the speed to change from the speed defined by parameter <i>46.01 Speed scaling</i> (not from parameter <i>30.12 Maximum speed</i>) to zero.</p> <p>If the speed reference decreases slower than the set deceleration rate, the motor speed will follow the reference.</p> <p>If the reference changes faster than the set deceleration rate, the motor speed will follow the deceleration rate.</p> <p>If the deceleration rate is set too short, the drive will automatically prolong the deceleration in order not to exceed drive torque limits (or not to exceed a safe DC link voltage). If there is any doubt about the deceleration time being too short, ensure that DC overvoltage control is on (parameter <i>30.30 Overvoltage control</i>).</p> <p>Note: If a short deceleration time is needed for a high inertia application, the drive should be equipped with braking equipment such as a brake chopper and brake resistor.</p>	3.000 s
	0.000 ...1800.000 s	Deceleration time 1.	10 = 1 s
23.14	<i>Acceleration time 2</i>	Defines acceleration time 2. See parameter <i>23.12 Acceleration time 1</i> .	60.000 s
	0.000 ...1800.000 s	Acceleration time 2.	10 = 1 s
23.15	<i>Deceleration time 2</i>	Defines deceleration time 2. See parameter <i>23.13 Deceleration time 1</i> .	60.000 s
	0.000 ...1800.000 s	Deceleration time 2.	10 = 1 s
23.20	<i>Acc time jogging</i>	<p>Defines the acceleration time for the jogging function ie. the time required for the speed to change from zero to the speed value defined by parameter <i>46.01 Speed scaling</i>.</p> <p>See section <i>Rush control</i> on page 63.</p>	60.000 s
	0.000 ...1800.000 s	Acceleration time for jogging.	10 = 1 s
23.21	<i>Dec time jogging</i>	<p>Defines the deceleration time for the jogging function ie. the time required for the speed to change from the speed value defined by parameter <i>46.01 Speed scaling</i> to zero.</p> <p>See section <i>Rush control</i> on page 63.</p>	60.000 s
	0.000 ...1800.000 s	Deceleration time for jogging.	10 = 1 s

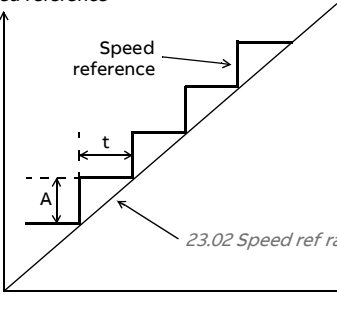
No.	Name/Value	Description	Default FbEq 16
23.23	<i>Emergency stop time</i>	<p>Defines the time inside which the drive is stopped if an emergency stop Off3 is activated (ie. the time required for the speed to change from the speed value defined by parameter <i>46.01 Speed scaling</i> or <i>46.02 Frequency scaling</i> to zero). Emergency stop mode and activation source are selected by parameters <i>21.04 Emergency stop mode</i> and <i>21.05 Emergency stop source</i> respectively. Emergency stop can also be activated through fieldbus.</p> <p>Note:</p> <ul style="list-style-type: none"> Emergency stop Off1 uses the standard deceleration ramp as defined by parameters <i>23.11...23.15</i>. The same parameter value is also used in frequency control mode (ramp parameters <i>28.71...28.75</i>). 	3.000 s
	0.000 ...1800.000 s	Emergency stop Off3 deceleration time.	10 = 1 s
23.28	<i>Variable slope enable</i>	<p>Activates the variable slope function, which controls the slope of the speed ramp during a speed reference change. This allows for a constantly variable ramp rate to be generated, instead of just the standard two ramps normally available.</p> <p>If the update interval of the signal from an external control system and the variable slope rate (<i>23.32 Variable slope rate</i>) are equal, speed reference (<i>23.02 Speed ref ramp output</i>) is a straight line.</p> <p><i>Speed reference</i></p>  <p>t = update interval of signal from external control system A = speed reference change during t</p> <p>This function is only active in remote control.</p>	<i>Off</i>
	Off	Variable slope disabled.	0
	On	Variable slope enabled (not available in local control).	1
23.29	<i>Variable slope rate</i>	<p>Defines the rate of the speed reference change when variable slope is enabled by parameter <i>23.28 Variable slope enable</i>.</p> <p>For the best result, enter the reference update interval into this parameter.</p>	50 ms
	2...30000 ms	Variable slope rate.	1 = 1 ms

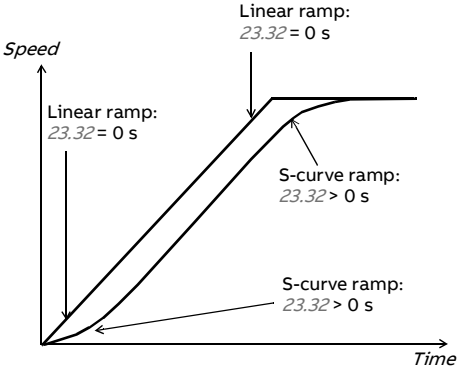
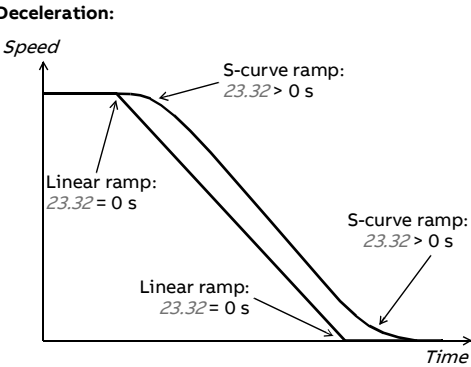
No.	Name/Value	Description	Default FbEq 16
23.32	<i>Shape time 1</i>	<p>Defines the shape of the acceleration and deceleration ramps used with the set 1.</p> <p>0.000 s: Linear ramp. Suitable for steady acceleration or deceleration and for slow ramps.</p> <p>0.001...1000.000 s: S-curve ramp. S-curve ramps are ideal for lifting applications. The S-curve consists of symmetrical curves at both ends of the ramp and a linear part in between.</p> <p>Acceleration:</p>  <p>Deceleration:</p> 	0.000 s
	0.100...1800.000 s	Ramp shape at start and end of acceleration and deceleration.	10 = 1 s
23.33	<i>Shape time 2</i>	Defines the shape of the acceleration and deceleration ramps used with the set 2. See parameter <i>23.32 Shape time 1</i> .	0.000 s
	0.100...1800.000 s	Ramp shape at start and end of acceleration and deceleration.	10 = 1 s

No.	Name/Value	Description	Default FbEq 16
	<i>24 Speed reference conditioning</i>	Speed error calculation; speed error window control configuration; speed error step. See the control chain diagram on page 408.	
<i>24.01</i>	<i>Used speed reference</i>	Displays the ramped and corrected speed reference (before speed error calculation). See the control chain diagram on page 408. This parameter is read-only.	-
	-30000.00... 30000.00 rpm	Speed reference used for speed error calculation.	See par. 46.01
<i>24.02</i>	<i>Used speed feedback</i>	Displays the speed feedback used for speed error calculation. See the control chain diagram on page 408. This parameter is read-only.	-
	-30000.00... 30000.00 rpm	Speed feedback used for speed error calculation.	See par. 46.01
<i>24.03</i>	<i>Speed error filtered</i>	Displays the filtered speed error. See the control chain diagram on page 408. This parameter is read-only.	-
	-30000.0... 30000.0 rpm	Filtered speed error.	See par. 46.01
<i>24.04</i>	<i>Speed error inverted</i>	Displays the inverted (unfiltered) speed error. See the control chain diagram on page 408. This parameter is read-only.	-
	-30000.0... 30000.0 rpm	Inverted speed error.	See par. 46.01
<i>24.11</i>	<i>Speed correction</i>	Defines a speed reference correction, ie. a value added to the existing reference between ramping and limitation. This is useful to trim the speed if necessary, for example to adjust draw between sections of a paper machine. See the control chain diagram on page 408.	0.00 rpm
	-10000.00... 10000.00 rpm	Speed reference correction.	See par. 46.01
<i>24.12</i>	<i>Speed error filter time</i>	Defines the time constant of the speed error low-pass filter. If the used speed reference changes rapidly, the possible interferences in the speed measurement can be filtered with the speed error filter. Reducing the ripple with this filter may cause speed controller tuning problems. A long filter time constant and fast acceleration time contradict one another. A very long filter time results in unstable control.	0 ms
	0...10000 ms	Speed error filtering time constant. 0 = filtering disabled.	1 = 1 ms

182 Parameters

No.	Name/Value	Description	Default FbEq 16
<i>25 Speed control</i>		Speed controller settings. See the control chain diagram on page 412.	
25.01	<i>Torque reference speed control</i>	Displays the speed controller output that is transferred to the torque controller. See the control chain diagram on page 412. This parameter is read-only.	-
	-1600.0...1600.0%	Limited speed controller output torque.	See par. 46.03
25.02	<i>Speed proportional gain</i>	Defines the proportional gain (K_p) of the speed controller. Too high a gain may cause speed oscillation. The figure below shows the speed controller output after an error step when the error remains constant. <div style="text-align: center;"> <p>Gain = $K_p = 1$ T_I = Integration time = 0 T_D = Derivation time = 0</p> </div>	5.00
	0.00 ...250.00	If gain is set to 1, a 10% change in error value (reference - actual value) causes the speed controller output to change by 10%, ie. the output value is input \times gain.	
	0.00 ...250.00	Proportional gain for speed controller.	100 = 1

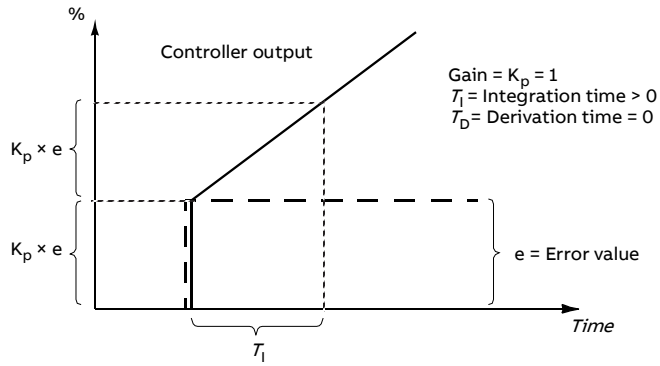
No.	Name/Value	Description	Default FbEq 16
25.03	<i>Speed integration time</i>	<p>Defines the integration time of the speed controller. The integration time defines the rate at which the controller output changes when the error value is constant and the proportional gain of the speed controller is 1. The shorter the integration time, the faster the continuous error value is corrected. This time constant must be set to the same order of magnitude as the time constant (time to respond) of the actual mechanical system being controlled, otherwise instability will result.</p> <p>Setting the integration time to zero disables the I-part of the controller. This is useful to do when tuning the proportional gain; adjust the proportional gain first, then return the integration time.</p> <p>Anti-windup (the integrator just integrates up to 100%) stops the integrator if the controller output is limited. See 06.05 Limit word1.</p> <p>The figure below shows the speed controller output after an error step when the error remains constant.</p> 	2.50 s
	0.00...1000.00 s	Integration time for speed controller.	10 = 1 s

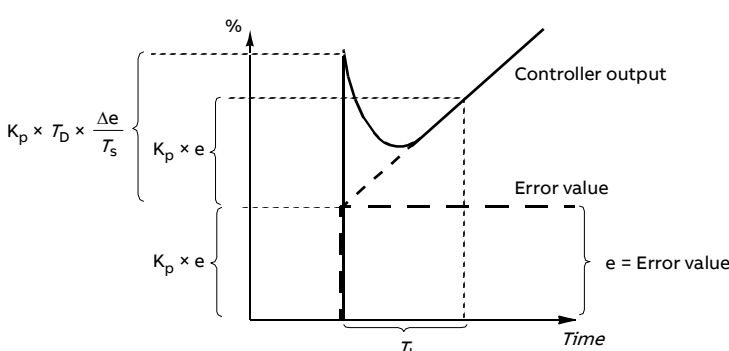
No.	Name/Value	Description	Default FbEq 16
25.04	<p><i>Speed derivation time</i></p> <p>Defines the derivation time of the speed controller. Derivative action boosts the controller output if the error value changes. The longer the derivation time, the more the speed controller output is boosted during the change. If the derivation time is set to zero, the controller works as a PI controller, otherwise as a PID controller. The derivation makes the control more responsive for disturbances. For simple applications (especially those without a pulse encoder), derivative time is not normally required and should be left at zero.</p> <p>The speed error derivative must be filtered with a low pass filter to eliminate disturbances.</p> <p>The figure below shows the speed controller output after an error step when the error remains constant.</p>  <p>Gain = $K_p = 1$ T_I = Integration time > 0 T_D = Derivation time > 0 T_s = Sample time period = 250 μs Δe = Error value change between two samples</p>	0.000 s	
	0.000...10.000 s	Derivation time for speed controller.	1000 = 1 s
25.05	<p><i>Derivation filter time</i></p> <p>Defines the derivation filter time constant. See parameter 25.04 <i>Speed derivation time</i>.</p>	8 ms	
	0...10000 ms	Derivation filter time constant.	1 = 1 ms

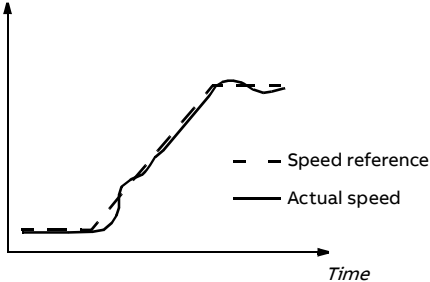
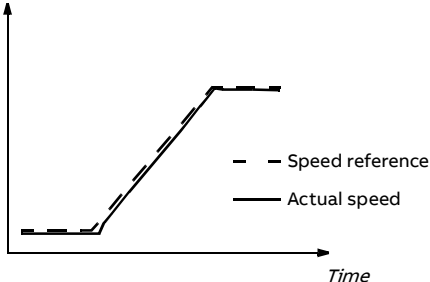
No.	Name/Value	Description	Default FbEq 16
25.06	<i>Acc comp derivation time</i>	<p>Defines the derivation time for acceleration(/deceleration) compensation. In order to compensate for a high inertia load during acceleration, a derivative of the reference is added to the output of the speed controller. The principle of a derivative action is described under parameter <i>25.04 Speed derivation time</i>.</p> <p>Note: As a general rule, set this parameter to the value between 50 and 100% of the sum of the mechanical time constants of the motor and the driven machine.</p> <p>The figure below shows the speed responses when a high inertia load is accelerated along a ramp.</p> <p>No acceleration compensation:</p>  <p>Acceleration compensation:</p> 	0.00 s
	0.00...1000.00 s	Acceleration compensation derivation time.	10 = 1 s
25.07	<i>Acc comp filter time</i>	Defines the acceleration (or deceleration) compensation filter time constant. See parameters <i>25.04 Speed derivation time</i> and <i>25.06 Acc comp derivation time</i> .	8.0 ms
	0.0...1000.0 ms	Acceleration/deceleration compensation filter time.	1 = 1 ms
25.15	<i>Proportional gain em stop</i>	Defines the proportional gain for the speed controller when an emergency stop is active. See parameter <i>25.02 Speed proportional gain</i> .	10.00
	1.00...250.00	Proportional gain upon an emergency stop.	100 = 1

186 Parameters

No.	Name/Value	Description	Default FbEq 16
25.30	<i>Flux adaptation enable</i>	Activates the flux adaption enable function.	Off
	Disable	Flux adaption disabled.	0
	Enable	Flux adaption enabled.	1
25.33	<i>Speed controller autotune</i>	Activates (or selects a source that activates) the speed controller auto tune function. See section <i>Speed controller autotune</i> (page 59). The autotune will automatically set parameters <i>25.02 Speed proportional gain</i> , <i>25.03 Speed integration time</i> and <i>25.37 Mechanical time constant</i> .	Off
	Off	Not activated.	0
	On	Activated.	1
	<i>Other [bit]</i>	Source selection (see <i>Terms and abbreviations</i>).	-
25.34	<i>Speed controller autotune mode</i>	Defines a control preset for the speed controller auto tune function. The setting affects the way the torque reference will respond to a speed reference step.	Normal
	Smooth	Slow yet robust response.	0
	Normal	Normal response.	1
	Tight	Fast response which can produce high gain value.	2
25.37	<i>Mechanical time constant</i>	Mechanical time constant of the drive and the machinery as determined by the speed controller autotune function. The value can be adjusted manually.	-
	0.00 ... 1000.00 s	Mechanical time constant.	10 = 1 s
25.38	<i>Autotune torque step</i>	Defines an added torque value used by the auto tune function. This value is scaled to the motor nominal torque. Note: The torque used by the auto tune function can also be limited by the torque limits (in parameter group <i>30 Limits</i>) and the nominal motor torque.	10.00%
	0.00 ... 20.00 %		
25.39	<i>Autotune speed step</i>	Defines a speed value added to the initial speed for the auto tune function. The initial speed (speed used when auto tune is activated) plus the value of this parameter is the calculated maximum speed used by the auto tune routine. The maximum speed can also be limited by the speed limits (in parameter group <i>30 Limits</i>) and nominal motor speed. The value is scaled to the motor nominal speed. Note: The motor will exceed the calculated maximum speed slightly at the end of each acceleration stage.	10%
	0.00 ... 20.00 %		
25.40	<i>Autotune repeat times</i>	Determines how many acceleration/deceleration cycles are performed during the auto tune routine. Increasing the value will improve the accuracy of the auto tune function, and allow the use of smaller torque or speed step values.	5
	1...10		

No.	Name/Value	Description	Default FbEq 16
25.53	<i>Torque prop reference</i>	Displays the output of the proportional (P) part of the speed controller. See the control chain diagram on page 412. This parameter is read-only.	-
	-30000.0... 30000.0%	P-part output of speed controller.	See par. 46.03
25.54	<i>Torque integral reference</i>	Displays the output of the integral (I) part of the speed controller. See the control chain diagram on page 412. This parameter is read-only.	-
	-30000.0... 30000.0%	I-part output of speed controller.	See par. 46.03
25.55	<i>Torque deriv reference</i>	Displays the output of the derivative (D) part of the speed controller. See the control chain diagram on page 412. This parameter is read-only.	-
	-30000.0... 30000.0%	D-part output of speed controller.	See par. 46.03
25.56	<i>Torque acc compensation</i>	Displays the output of the acceleration compensation function. See the control chain diagram on page 412. This parameter is read-only.	-
	-30000.0... 30000.0%	Output of acceleration compensation function.	See par. 46.03
<i>26 Torque reference chain</i>		Settings for the torque reference chain. See the control chain diagrams on pages 413 and 414.	
26.01	<i>Torque reference to TC</i>	Displays the final torque reference given to the torque controller in percent. This reference is then acted upon by various final limiters, like power, torque, load etc. See the control chain diagrams on pages 413 and 414. This parameter is read-only.	-
	-1600.0...1600.0%	Torque reference for torque control.	See par. 46.03
26.02	<i>Torque reference used</i>	Displays the final torque reference (in percent of motor nominal torque) given to the torque controller, and comes after frequency, voltage and torque limitation. See the control chain diagram on page 413. This parameter is read-only.	-
	-1600.0...1600.0%	Torque reference for torque control.	See par. 46.03
26.08	<i>Minimum torque ref</i>	Defines the minimum torque reference. Allows for local limiting of the torque reference before it is passed on to the torque ramp controller. For absolute torque limiting, refer to parameter 30.19 <i>Minimum torque 1</i> .	-300.0%
	-1000.0...0.0%	Minimum torque reference.	See par. 46.03

No.	Name/Value	Description	Default FbEq 16
26.09	Maximum torque ref	Defines the maximum torque reference. Allows for local limiting of the torque reference before it is passed on to the torque ramp controller. For absolute torque limiting, refer to parameter 30.20 Maximum torque 1.	300.0%
	0.0...1000.0%	Maximum torque reference.	See par. 46.03
26.11	Torque ref1 source	Selects torque reference source 1. Two signal sources can be defined by this parameter and 26.12 Torque ref2 source. A digital source selected by 26.14 Torque ref1/2 selection can be used to switch between the two sources, or a mathematical function (26.13 Torque ref1 function) applied to the two signals to create the reference.	Zero

Zero	None.	0
AI1 scaled	12.12 AI1 scaled value (see page 137).	1
AI2 scaled	12.22 AI2 scaled value (see page 139).	2
EFB ref1	03.09 EFB reference 1 (see page 114).	8
EFB ref2	03.10 EFB reference 2 (see page 115).	9
Motor potentiometer	22.80 Motor potentiometer ref act (output of the motor potentiometer).	15
PID	40.01 Process PID output actual (output of the process PID controller).	16
Frequency input	11.38 Freq in 1 actual value (when DI3 or DI4 is used as a frequency input).	17

No.	Name/Value	Description	Default FbEq 16
	Control panel (ref saved)	<p>Panel reference (<i>03.01 Panel reference</i>, see page 114) saved by the control system for the location where the control returns is used as the reference.</p> <p><i>Reference</i></p> <ul style="list-style-type: none"> ● Ext1 reference × Ext2 reference — Active reference - - - Inactive reference 	18
	Control panel (ref copied)	<p>Panel reference (<i>03.01 Panel reference</i>, see page 114) for the previous control location is used as the reference when the control location changes if the references for the two locations are of the same type (eg frequency/speed/torque/PID); otherwise, the actual signal is used as the new reference.</p> <p><i>Reference</i></p> <ul style="list-style-type: none"> ● Ext1 reference × Ext2 reference — Active reference - - - Inactive reference 	19
	Integrated panel (ref saved)	See above Control panel (ref saved)	20
	Integrated panel (ref copied)	See above Control panel (ref copied).	21
	Frequency input 2	<i>11.46 Freq in 2 actual value</i> (when DI3 or DI4 is used as a frequency input).	22
	<i>Other</i>	Source selection (see <i>Terms and abbreviations</i>).	-
26.12	<i>Torque ref2 source</i>	Selects torque reference source 2. For the selections, and a diagram of reference source selection, see parameter <i>26.11 Torque ref1 source</i> .	<i>Zero</i>
26.13	<i>Torque ref1 function</i>	Selects a mathematical function between the reference sources selected by parameters <i>26.11 Torque ref1 source</i> and <i>26.12 Torque ref2 source</i> . See diagram at <i>26.11 Torque ref1 source</i> .	<i>Ref1</i>
	Ref1	Signal selected by <i>26.11 Torque ref1 source</i> is used as torque reference 1 as such (no function applied).	0
	Add (ref1 + ref2)	The sum of the reference sources is used as torque reference 1.	1
	Sub (ref1 - ref2)	The subtraction ($[26.11 \text{ Torque ref1 source}] - [26.12 \text{ Torque ref2 source}]$) of the reference sources is used as torque reference 1.	2
	Mul (ref1 × ref2)	The multiplication of the reference sources is used as torque reference 1.	3
	Min (ref1, ref2)	The smaller of the reference sources is used as torque reference 1.	4
	Max (ref1, ref2)	The greater of the reference sources is used as torque reference 1.	5

190 Parameters

No.	Name/Value	Description	Default FbEq 16
26.14	<i>Torque ref1/2 selection</i>	Configures the selection between torque references 1 and 2. See diagram at 26.11 <i>Torque ref1 source</i> . 0 = Torque reference 1 1 = Torque reference 2	<i>Torque reference 1</i>
	Torque reference 1	0.	0
	Torque reference 2	1.	1
	Follow Ext1/Ext2 selection	Torque reference 1 is used when external control location EXT1 is active. Torque reference 2 is used when external control location EXT2 is active. See also parameter 19.11 <i>Ext1/Ext2 selection</i> .	2
	DI1	Digital input DI1 (10.02 <i>DI delayed status</i> , bit 0).	3
	DI2	Digital input DI2 (10.02 <i>DI delayed status</i> , bit 1).	4
	DI3	Digital input DI3 (10.02 <i>DI delayed status</i> , bit 2).	5
	DI4	Digital input DI4 (10.02 <i>DI delayed status</i> , bit 3).	6
	DI5	Digital input DI5 (10.02 <i>DI delayed status</i> , bit 4).	7
	<i>Other [bit]</i>	Source selection (see <i>Terms and abbreviations</i>).	-
26.17	<i>Torque ref filter time</i>	Defines a low-pass filter time constant for the torque reference.	0.000 s
	0.000...30.000 s	Filter time constant for torque reference.	1000 = 1 s
26.18	<i>Torque ramp up time</i>	Defines the torque reference ramp-up time, ie. the time for the reference to increase from zero to nominal motor torque.	0.000 s
	0.000...60.000 s	Torque reference ramp-up time.	100 = 1 s
26.19	<i>Torque ramp down time</i>	Defines the torque reference ramp-down time, ie. the time for the reference to decrease from nominal motor torque to zero.	0.000 s
	0.000...60.000 s	Torque reference ramp-down time.	100 = 1 s
26.20	<i>Torque reversal</i>	Inverts the torque reference or selects the source for the inversion signal. Torque reversal is located in the torque reference chain after torque reference act 3 signal, so the inversion is visible in torque reference act 4 signal.	<i>Always off</i>
	Always off	Torque reference is not inverted.	0
	Always on	Torque reference is inverted.	1
	DI1	Digital input DI1 (10.02 <i>DI delayed status</i> , bit 0).	2
	DI2	Digital input DI2 (10.02 <i>DI delayed status</i> , bit 1).	3
	DI3	Digital input DI3 (10.02 <i>DI delayed status</i> , bit 2).	4
	DI4	Digital input DI4 (10.02 <i>DI delayed status</i> , bit 3).	5
	DI5	Digital input DI5 (10.02 <i>DI delayed status</i> , bit 4).	6
	Supervision 1	Bit 0 of 32.01 <i>Supervision status</i> .	24
	Supervision 2	Bit 1 of 32.01 <i>Supervision status</i> .	25
	Supervision 3	Bit 2 of 32.01 <i>Supervision status</i> .	26
	Supervision 4	Bit 3 of 32.01 <i>Supervision status</i> .	27
	Supervision 5	Bit 4 of 32.01 <i>Supervision status</i> .	28
	Supervision 6	Bit 5 of 32.01 <i>Supervision status</i> .	29

No.	Name/Value	Description	Default FbEq 16
	<i>Other [bit]</i>	Source selection (see <i>Terms and abbreviations</i>).	-
26.70	<i>Torque reference act 1</i>	Displays the value of torque reference source 1 (selected by parameter <i>26.11 Torque ref1 source</i>). See the control chain diagram on page 413. This parameter is read-only.	-
	-1600.0...1600.0%	Value of torque reference source 1.	See par. 46.03
26.71	<i>Torque reference act 2</i>	Displays the value of torque reference source 2 (selected by parameter <i>26.12 Torque ref2 source</i>). See the control chain diagram on page 413. This parameter is read-only.	-
	-1600.0...1600.0%	Value of torque reference source 2.	See par. 46.03
26.72	<i>Torque reference act 3</i>	Displays the torque reference after the function applied by parameter <i>26.13 Torque ref1 function</i> (if any), and after selection (<i>26.14 Torque ref1/2 selection</i>). See the control chain diagram on page 413. This parameter is read-only.	-
	-1600.0...1600.0%	Torque reference after selection.	See par. 46.03
26.73	<i>Torque reference act 4</i>	Displays the torque reference after application of reference additive 1. See the control chain diagram on page 413. This parameter is read-only.	-
	-1600.0...1600.0%	Torque reference after application of reference additive 1.	See par. 46.03
26.74	<i>Torque ref ramp out</i>	Displays the torque reference after limiting and ramping. See the control chain diagram on page 413. This parameter is read-only.	-
	-1600.0...1600.0%	Torque reference after limiting and ramping.	See par. 46.03
26.75	<i>Torque reference act 5</i>	Displays the torque reference after control mode selection. See the control chain diagram on page 414. This parameter is read-only.	-
	-1600.0...1600.0%	Torque reference after control mode selection.	See par. 46.03
26.76	<i>Torque reference act 6</i>	Displays the torque reference after torque trim. See the control chain diagram on page 414. This parameter is read-only.	-
	-1600.0...1600.0%	Torque reference	See par. 46.03
26.81	<i>Rush control gain</i>	Rush controller gain term. See section <i>Rush control</i> (page 63).	5.0
	0.0 ...10000.0	Rush controller gain (0.0 = disabled).	1 = 1
26.82	<i>Rush control integration time</i>	Rush controller integration time term.	2.0 s
	0.0 ...10.0 s	Rush controller integration time (0.0 = disabled).	1 = 1 s

192 Parameters

No.	Name/Value	Description	Default FbEq 16
<i>28 Frequency reference chain</i>		Settings for the frequency reference chain. See the control chain diagrams on pages 416 and 414.	
<i>28.01</i>	<i>Frequency ref ramp input</i>	Displays the used frequency reference before ramping. See the control chain diagram on page 413. This parameter is read-only.	-
	-500.00...500.00 Hz	Frequency reference before ramping.	See par. 46.02
<i>28.02</i>	<i>Frequency ref ramp output</i>	Displays the final frequency reference (after selection, limitation and ramping). See the control chain diagram on page 413. This parameter is read-only.	-
	-500.00...500.00 Hz	Final frequency reference.	See par. 46.02

No.	Name/Value	Description	Default FbEq 16
28.11	Ext1 frequency ref1	<p>Selects Ext1 frequency reference source 1.</p> <p>Two signal sources can be defined by this parameter and 28.12 Ext1 frequency ref2. A mathematical function (28.13 Ext1 frequency function) applied to the two signals creates an Ext1 reference (A in the figure below).</p> <p>A digital source selected by 19.11 Ext1/Ext2 selection can be used to switch between Ext1 reference and the corresponding Ext2 reference defined by parameters 28.15 Ext2 frequency ref1, 28.16 Ext2 frequency ref2 and 28.17 Ext2 frequency function (B in the figure below).</p> <p>Note: The default value depends on the selected macro. See chapter <i>Control macros</i> on page 27.</p>	Integrated panel (ref saved)

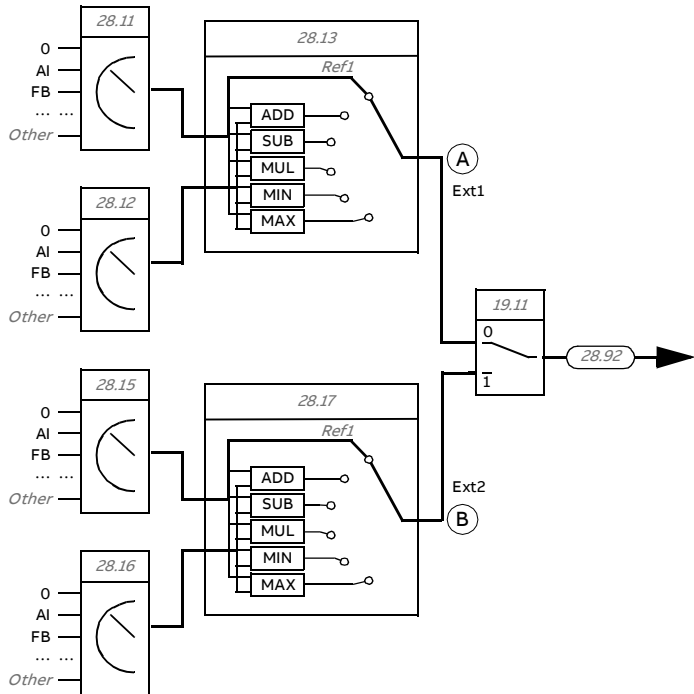

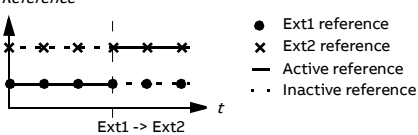
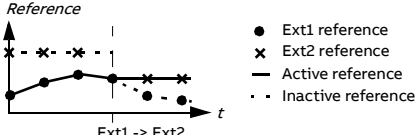

Zero	None.	0
AI1 scaled	12.12 AI1 scaled value (see page 137).	1
AI2 scaled	12.22 AI2 scaled value (see page 139).	2
EFB ref1	03.09 EFB reference 1 (see page 114).	8
EFB ref2	03.10 EFB reference 2 (see page 115).	9
Motor potentiometer	22.80 Motor potentiometer ref act (output of the motor potentiometer).	15

No.	Name/Value	Description	Default FbEq 16
	PID	40.01 Process PID output actual (output of the process PID controller).	16
	Frequency input 1	11.38 Freq in 1 actual value (when DI3 or DI4 is used as a frequency input).	17
	Control panel (ref saved)	Panel reference (03.01 Panel reference, see page 114) saved by the control system for the location where the control returns is used as the reference. Reference 	18
	Control panel (ref copied)	Panel reference (03.01 Panel reference, see page 114) for the previous control location is used as the reference when the control location changes if the references for the two locations are of the same type (eg frequency/speed/torque/PID); otherwise, the actual signal is used as the new reference. Reference 	19
	Integrated panel (ref saved)	See above Control panel (ref saved).	20
	Integrated panel (ref copied)	See above Control panel (ref copied).	21
	Frequency input 2	11.46 Freq in 2 actual value (when DI3 or DI4 is used as a frequency input).	22
	Other	Source selection (see Terms and abbreviations).	-
28.12	Ext1 frequency ref2	Selects Ext1 frequency reference source 2. For the diagram of reference source selection, see parameter 28.11 Ext1 frequency ref1.	Zero
	Zero	None.	0
	AI1 scaled	12.12 AI1 scaled value (see page 137).	1
	AI2 scaled	12.22 AI2 scaled value (see page 139).	2
	EFB ref1	03.09 EFB reference 1 (see page 114).	8
	EFB ref2	03.10 EFB reference 2 (see page 115).	9
	Motor potentiometer	22.80 Motor potentiometer ref act (output of the motor potentiometer).	15
	PID	40.01 Process PID output actual (output of the process PID controller).	16
	Frequency input 1	11.38 Freq in 1 actual value (when DI3 or DI4 is used as a frequency input).	17

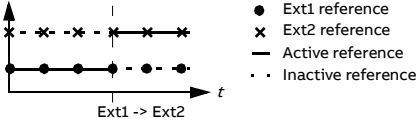
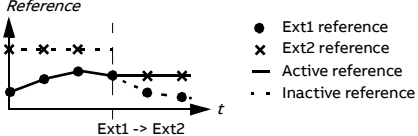
No.	Name/Value	Description	Default FbEq 16
	Control panel (ref saved)	<p>Panel reference (<i>03.01 Panel reference</i>, see page 114) saved by the control system for the location where the control returns is used as the reference.</p> <p><i>Reference</i></p> <p>● Ext1 reference x Ext2 reference — Active reference ... Inactive reference</p>	18
	Control panel (ref copied)	<p>Panel reference (<i>03.01 Panel reference</i>, see page 114) for the previous control location is used as the reference when the control location changes if the references for the two locations are of the same type (eg frequency/speed/torque/PID); otherwise, the actual signal is used as the new reference.</p> <p><i>Reference</i></p> <p>● Ext1 reference x Ext2 reference — Active reference ... Inactive reference</p>	19
	Integrated panel (ref saved)	See above Control panel (ref saved).	20
	Integrated panel (ref copied)	See above Control panel (ref copied).	21
	Frequency input 2	<i>11.46 Freq in 2 actual value</i> (when DI3 or DI4 is used as a frequency input).	22
	<i>Other</i>	Source selection (see <i>Terms and abbreviations</i>).	-
28.13	<i>Ext1 frequency function</i>	Selects a mathematical function between the reference sources selected by parameters <i>28.11 Ext1 frequency ref1</i> and <i>28.12 Ext1 frequency ref2</i> . See diagram at <i>28.11 Ext1 frequency ref1</i> .	<i>Ref1</i>
	Ref1	Signal selected by <i>28.11 Ext1 frequency ref1</i> is used as frequency reference 1 as such (no function applied).	0
	Add (ref1 + ref2)	The sum of the reference sources is used as frequency reference 1.	1
	Sub (ref1 - ref2)	The subtraction ($[28.11 \text{ Ext1 frequency ref1}] - [28.12 \text{ Ext1 frequency ref2}]$) of the reference sources is used as frequency reference 1.	2
	Mul (ref1 × ref2)	The multiplication of the reference sources is used as frequency reference 1.	3
	Min (ref1, ref2)	The smaller of the reference sources is used as frequency reference 1.	4
	Max (ref1, ref2)	The greater of the reference sources is used as frequency reference 1.	5

No.	Name/Value	Description	Default FbEq 16
28.15	Ext2 frequency ref1	Selects Ext2 frequency reference source 1. Two signal sources can be defined by this parameter and 28.16 Ext2 frequency ref2. A mathematical function (28.17 Ext2 frequency function) applied to the two signals creates an Ext2 reference. See diagram at 28.11 Ext1 frequency ref1.	Zero
	Zero	None.	0
	AI1 scaled	12.12 AI1 scaled value (see page 137).	1
	AI2 scaled	12.22 AI2 scaled value (see page 139).	2
	EFB ref1	03.09 EFB reference 1 (see page 114).	8
	EFB ref2	03.10 EFB reference 2 (see page 115).	9
	Motor potentiometer	22.80 Motor potentiometer ref act(output of the motor potentiometer).	15
	PID	40.01 Process PID output actual (output of the process PID controller).	16
	Frequency input 1	11.38 Freq in 1 actual value (when DI3 or DI4 is used as a frequency input).	17
	Control panel (ref saved)	Panel reference (03.01 Panel reference, see page 114) saved by the control system for the location where the control returns is used as the reference. Reference 	18
	Control panel (ref copied)	Panel reference (03.01 Panel reference, see page 114) for the previous control location is used as the reference when the control location changes if the references for the two locations are of the same type (eg frequency/speed/torque/PID); otherwise, the actual signal is used as the new reference. Reference 	19
	Integrated panel (ref saved)	See above Control panel (ref saved).	20
	Integrated panel (ref copied)	See above Control panel (ref copied).	21
	Frequency input 2	11.46 Freq in 2 actual value (when DI3 or DI4 is used as a frequency input).	22
	Other	Source selection (see Terms and abbreviations).	-
28.16	Ext2 frequency ref2	Selects Ext2 frequency reference source 2. For the selections, and a diagram of reference source selection, see parameter 28.15 Ext2 frequency ref1.	Zero

No.	Name/Value	Description	Default FbEq 16															
28.17	<i>Ext2 frequency function</i>	Selects a mathematical function between the reference sources selected by parameters 28.15 <i>Ext2 frequency ref1</i> and 28.16 <i>Ext2 frequency ref2</i> . See diagram at 28.15 <i>Ext2 frequency ref1</i> .	<i>Ref1</i>															
	Ref1	Signal selected by 28.15 <i>Ext2 frequency ref1</i> is used as frequency reference 1 as such (no function applied).	0															
	Add (ref1 + ref2)	The sum of the reference sources is used as frequency reference 1.	1															
	Sub (ref1 - ref2)	The subtraction ([28.15 <i>Ext2 frequency ref1</i>] - [28.16 <i>Ext2 frequency ref2</i>]) of the reference sources is used as frequency reference 1.	2															
	Mul (ref1 × ref2)	The multiplication of the reference sources is used as frequency reference 1.	3															
	Min (ref1, ref2)	The smaller of the reference sources is used as frequency reference 1.	4															
	Max (ref1, ref2)	The greater of the reference sources is used as frequency reference 1.	5															
28.21	<i>Constant frequency function</i>	Determines how constant frequencies are selected, and whether the rotation direction signal is considered or not when applying a constant frequency.	0b00001															
<table border="1"> <thead> <tr> <th>Bit</th> <th>Name</th> <th>Information</th> </tr> </thead> <tbody> <tr> <td>0</td> <td>Const freq mode</td> <td>1 = Packed: 7 constant frequencies are selectable using the three sources defined by parameters 28.22, 28.23 and 28.24. 0 = Separate: Constant frequencies 1, 2 and 3 are separately activated by the sources defined by parameters 28.22, 28.23 and 28.24 respectively. In case of conflict, the constant frequency with the smaller number takes priority.</td> </tr> <tr> <td>1</td> <td>Direction enable</td> <td>1 = Start dir: To determine running direction for a constant frequency, the sign of the constant frequency setting (parameters 28.26...28.32) is multiplied by the direction signal (forward: +1, reverse: -1). This effectively allows the drive to have 14 (7 forward, 7 reverse) constant frequencies if all values in 28.26...28.32 are positive.  WARNING! If the direction signal is reverse and the active constant frequency is negative, the drive will run in the forward direction. 0 = According to Par: The running direction for the constant frequency is determined by the sign of the constant speed setting (parameters 28.26...28.32).</td> </tr> <tr> <td>2</td> <td>Frequency step</td> <td>Frequency step: 1 = Freq step enable; 0 = Freq step disable</td> </tr> <tr> <td>3...15</td> <td>Reserved</td> <td></td> </tr> </tbody> </table>				Bit	Name	Information	0	Const freq mode	1 = Packed: 7 constant frequencies are selectable using the three sources defined by parameters 28.22, 28.23 and 28.24. 0 = Separate: Constant frequencies 1, 2 and 3 are separately activated by the sources defined by parameters 28.22, 28.23 and 28.24 respectively. In case of conflict, the constant frequency with the smaller number takes priority.	1	Direction enable	1 = Start dir: To determine running direction for a constant frequency, the sign of the constant frequency setting (parameters 28.26...28.32) is multiplied by the direction signal (forward: +1, reverse: -1). This effectively allows the drive to have 14 (7 forward, 7 reverse) constant frequencies if all values in 28.26...28.32 are positive.  WARNING! If the direction signal is reverse and the active constant frequency is negative, the drive will run in the forward direction. 0 = According to Par: The running direction for the constant frequency is determined by the sign of the constant speed setting (parameters 28.26...28.32).	2	Frequency step	Frequency step: 1 = Freq step enable; 0 = Freq step disable	3...15	Reserved	
Bit	Name	Information																
0	Const freq mode	1 = Packed: 7 constant frequencies are selectable using the three sources defined by parameters 28.22, 28.23 and 28.24. 0 = Separate: Constant frequencies 1, 2 and 3 are separately activated by the sources defined by parameters 28.22, 28.23 and 28.24 respectively. In case of conflict, the constant frequency with the smaller number takes priority.																
1	Direction enable	1 = Start dir: To determine running direction for a constant frequency, the sign of the constant frequency setting (parameters 28.26...28.32) is multiplied by the direction signal (forward: +1, reverse: -1). This effectively allows the drive to have 14 (7 forward, 7 reverse) constant frequencies if all values in 28.26...28.32 are positive.  WARNING! If the direction signal is reverse and the active constant frequency is negative, the drive will run in the forward direction. 0 = According to Par: The running direction for the constant frequency is determined by the sign of the constant speed setting (parameters 28.26...28.32).																
2	Frequency step	Frequency step: 1 = Freq step enable; 0 = Freq step disable																
3...15	Reserved																	
0b0000...0b1111		Constant frequency configuration word.	1 = 1															

No.	Name/Value	Description	Default FbEq 16																																				
28.22	<i>Constant frequency sel1</i>	<p>When bit 0 of parameter <i>28.21 Constant frequency function</i> is 0 (Separate), selects a source that activates constant frequency 1.</p> <p>Note: The default value depends on the selected macro. See chapter <i>Control macros</i> on page 27.</p> <p>When bit 0 of parameter <i>28.21 Constant frequency function</i> is 1 (Packed), this parameter and parameters <i>28.23 Constant frequency sel2</i> and <i>28.24 Constant frequency sel3</i> select three sources whose states activate constant frequencies as follows:</p>	<i>DI2</i>																																				
<table border="1"> <thead> <tr> <th>Source defined by par. 28.22</th> <th>Source defined by par. 28.23</th> <th>Source defined by par. 28.24</th> <th>Constant frequency active</th> </tr> </thead> <tbody> <tr> <td>0</td> <td>0</td> <td>0</td> <td>None</td> </tr> <tr> <td>1</td> <td>0</td> <td>0</td> <td>Constant frequency 1</td> </tr> <tr> <td>0</td> <td>1</td> <td>0</td> <td>Constant frequency 2</td> </tr> <tr> <td>1</td> <td>1</td> <td>0</td> <td>Constant frequency 3</td> </tr> <tr> <td>0</td> <td>0</td> <td>1</td> <td>Constant frequency 4</td> </tr> <tr> <td>1</td> <td>0</td> <td>1</td> <td>Constant frequency 5</td> </tr> <tr> <td>0</td> <td>1</td> <td>1</td> <td>Constant frequency 6</td> </tr> <tr> <td>1</td> <td>1</td> <td>1</td> <td>Constant frequency 7</td> </tr> </tbody> </table>				Source defined by par. 28.22	Source defined by par. 28.23	Source defined by par. 28.24	Constant frequency active	0	0	0	None	1	0	0	Constant frequency 1	0	1	0	Constant frequency 2	1	1	0	Constant frequency 3	0	0	1	Constant frequency 4	1	0	1	Constant frequency 5	0	1	1	Constant frequency 6	1	1	1	Constant frequency 7
Source defined by par. 28.22	Source defined by par. 28.23	Source defined by par. 28.24	Constant frequency active																																				
0	0	0	None																																				
1	0	0	Constant frequency 1																																				
0	1	0	Constant frequency 2																																				
1	1	0	Constant frequency 3																																				
0	0	1	Constant frequency 4																																				
1	0	1	Constant frequency 5																																				
0	1	1	Constant frequency 6																																				
1	1	1	Constant frequency 7																																				
	Always off	0 (always off).	0																																				
	Always on	1 (always on).	1																																				
	DI1	Digital input DI1 (<i>10.02 DI delayed status</i> , bit 0).	2																																				
	DI2	Digital input DI2 (<i>10.02 DI delayed status</i> , bit 1).	3																																				
	DI3	Digital input DI3 (<i>10.02 DI delayed status</i> , bit 2).	4																																				
	DI4	Digital input DI4 (<i>10.02 DI delayed status</i> , bit 3).	5																																				
	DI5	Digital input DI5 (<i>10.02 DI delayed status</i> , bit 4).	6																																				
	Supervision 1	Bit 0 of <i>32.01 Supervision status</i> .	24																																				
	Supervision 2	Bit 1 of <i>32.01 Supervision status</i> .	25																																				
	Supervision 3	Bit 2 of <i>32.01 Supervision status</i> .	26																																				
	Supervision 4	Bit 3 of <i>32.01 Supervision status</i> .	27																																				
	Supervision 5	Bit 4 of <i>32.01 Supervision status</i> .	28																																				
	Supervision 6	Bit 5 of <i>32.01 Supervision status</i> .	29																																				
	<i>Other [bit]</i>	Source selection (see <i>Terms and abbreviations</i>).	-																																				
28.23	<i>Constant frequency sel2</i>	<p>When bit 0 of parameter <i>28.21 Constant frequency function</i> is 0 (Separate), selects a source that activates constant frequency 2.</p> <p>When bit 0 of parameter <i>28.21 Constant frequency function</i> is 1 (Packed), this parameter and parameters <i>28.22 Constant frequency sel1</i> and <i>28.24 Constant frequency sel3</i> select three sources that are used to activate constant frequencies. See table at parameter <i>28.22 Constant frequency sel1</i>.</p> <p>For the selections, see parameter <i>28.22 Constant frequency sel1</i>.</p> <p>Note: The default value depends on the selected macro. See <i>Control macros</i> on page 27.</p>	<i>Always off</i>																																				

No.	Name/Value	Description	Default FbEq 16
28.24	<i>Constant frequency sel3</i>	When bit 0 of parameter <i>28.21 Constant frequency function</i> is 0 (Separate), selects a source that activates constant frequency 3. When bit 0 of parameter <i>28.21 Constant frequency function</i> is 1 (Packed), this parameter and parameters <i>28.22 Constant frequency sel1</i> and <i>28.23 Constant frequency sel2</i> select three sources that are used to activate constant frequencies. See table at parameter <i>28.22 Constant frequency sel1</i> . For the selections, see parameter <i>28.22 Constant frequency sel1</i> .	Always off
28.26	<i>Constant frequency 1</i>	Defines constant frequency 1 (the frequency the motor will turn when constant frequency 1 is selected).	5.00 Hz
	-500.00...500.00 Hz	Constant frequency 1.	See par. 46.02
28.27	<i>Constant frequency 2</i>	Defines constant frequency 2.	10.00 Hz
	-500.00...500.00 Hz	Constant frequency 2.	See par. 46.02
28.28	<i>Constant frequency 3</i>	Defines constant frequency 3.	15.00 Hz
	-500.00...500.00 Hz	Constant frequency 3.	See par. 46.02
28.29	<i>Constant frequency 4</i>	Defines constant frequency 4.	20.00 Hz
	-500.00...500.00 Hz	Constant frequency 4.	See par. 46.02
28.30	<i>Constant frequency 5</i>	Defines constant frequency 5.	25.00 Hz
	-500.00...500.00 Hz	Constant frequency 5.	See par. 46.02
28.31	<i>Constant frequency 6</i>	Defines constant frequency 6.	40.00 Hz
	-500.00...500.00 Hz	Constant frequency 6.	See par. 46.02
28.32	<i>Constant frequency 7</i>	Defines constant frequency 7.	50.00 Hz
	-500.00...500.00 Hz	Constant frequency 7.	See par. 46.02
28.41	<i>Frequency ref safe</i>	Defines a safe frequency reference value that is used with supervision functions such as <ul style="list-style-type: none"> • <i>12.03 AI supervision function</i> • <i>49.05 Communication loss action.</i> 	0.00 Hz
	-500.00...500.00 Hz	Safe frequency reference.	See par. 46.02
28.42	<i>Jogging 1 frequency ref</i>	Defines the frequency reference for jogging function 1 in scalar control mode.	0.00Hz
	-500.00...500.00 Hz	Jogging 1 frequency reference.	See par. 46.02
28.43	<i>Jogging 2 frequency ref</i>	Defines the frequency reference for jogging function 2 in scalar control mode.	0.00Hz
	-500.00...500.00 Hz	Jogging 2 frequency reference.	See par. 46.02

No.	Name/Value	Description	Default FbEq 16									
28.51	<i>Critical frequency function</i>	Enables/disables the critical frequencies function. Also determines whether the specified ranges are effective in both rotating directions or not. See also section <i>Critical speeds/frequencies</i> on page 58.	0000h									
<table border="1"> <thead> <tr> <th>Bit</th> <th>Name</th> <th>Information</th> </tr> </thead> <tbody> <tr> <td>0</td> <td>Crit freq</td> <td>1 = Enable: Critical frequencies enabled. 0 = Disable: Critical frequencies disabled.</td> </tr> <tr> <td>1</td> <td>Sign mode</td> <td>1 = According to par: The signs of parameters 28.52...28.57 are taken into account. 0 = Absolute: Parameters 28.52...28.57 are handled as absolute values. Each range is effective in both directions of rotation.</td> </tr> </tbody> </table>				Bit	Name	Information	0	Crit freq	1 = Enable: Critical frequencies enabled. 0 = Disable: Critical frequencies disabled.	1	Sign mode	1 = According to par: The signs of parameters 28.52...28.57 are taken into account. 0 = Absolute: Parameters 28.52...28.57 are handled as absolute values. Each range is effective in both directions of rotation.
Bit	Name	Information										
0	Crit freq	1 = Enable: Critical frequencies enabled. 0 = Disable: Critical frequencies disabled.										
1	Sign mode	1 = According to par: The signs of parameters 28.52...28.57 are taken into account. 0 = Absolute: Parameters 28.52...28.57 are handled as absolute values. Each range is effective in both directions of rotation.										
0000h...FFFFh		Critical frequencies configuration word.	1 = 1									
28.52	<i>Critical frequency 1 low</i>	Defines the low limit for critical frequency 1. Note: This value must be less than or equal to the value of 28.53 <i>Critical frequency 1 high</i> .	0.00 Hz									
-500.00...500.00 Hz		Low limit for critical frequency 1.	See par. 46.02									
28.53	<i>Critical frequency 1 high</i>	Defines the high limit for critical frequency 1. Note: This value must be greater than or equal to the value of 28.52 <i>Critical frequency 1 low</i> .	0.00 Hz									
-500.00...500.00 Hz		High limit for critical frequency 1.	See par. 46.02									
28.54	<i>Critical frequency 2 low</i>	Defines the low limit for critical frequency 2. Note: This value must be less than or equal to the value of 28.55 <i>Critical frequency 2 high</i> .	0.00 Hz									
-500.00...500.00 Hz		Low limit for critical frequency 2.	See par. 46.02									
28.55	<i>Critical frequency 2 high</i>	Defines the high limit for critical frequency 2. Note: This value must be greater than or equal to the value of 28.54 <i>Critical frequency 2 low</i> .	0.00 Hz									
-500.00...500.00 Hz		High limit for critical frequency 2.	See par. 46.02									
28.56	<i>Critical frequency 3 low</i>	Defines the low limit for critical frequency 3. Note: This value must be less than or equal to the value of 28.57 <i>Critical frequency 3 high</i> .	0.00 Hz									
-500.00...500.00 Hz		Low limit for critical frequency 3.	See par. 46.02									
28.57	<i>Critical frequency 3 high</i>	Defines the high limit for critical frequency 3. Note: This value must be greater than or equal to the value of 28.56 <i>Critical frequency 3 low</i> .	0.00 Hz									
-500.00...500.00 Hz		High limit for critical frequency 3.	See par. 46.02									

No.	Name/Value	Description	Default FbEq 16
28.71	<i>Freq ramp set selection</i>	Selects a source that switches between the two sets of acceleration/deceleration times defined by parameters 28.72...28.75. 0 = Acceleration time 1 and deceleration time 1 are in force. 1 = Acceleration time 2 and deceleration time 2 are in force. Note: The default value depends on the selected macro. See chapter <i>Control macros</i> on page 27.	<i>Acc/Dec time 1</i>
	Acc/Dec time 1	0	0
	Acc/Dec time 2	1	1
	DI1	Digital input DI1 (<i>10.02 DI delayed status</i> , bit 0).	2
	DI2	Digital input DI2 (<i>10.02 DI delayed status</i> , bit 1).	3
	DI3	Digital input DI3 (<i>10.02 DI delayed status</i> , bit 2).	4
	DI4	Digital input DI4 (<i>10.02 DI delayed status</i> , bit 3).	5
	DI5	Digital input DI5 (<i>10.02 DI delayed status</i> , bit 4).	6
	EFB DCU CW bit 10	Only for the DCU profile. DCU control word bit 10 received through the embedded fieldbus interface.	20
	<i>Other [bit]</i>	Source selection (see <i>Terms and abbreviations</i>).	-
28.72	<i>Freq acceleration time 1</i>	Defines acceleration time 1 as the time required for the frequency to change from zero to the frequency defined by parameter 46.02 <i>Frequency scaling</i> . After this frequency has been reached, the acceleration continues with the same rate to the value defined by parameter 30.14 <i>Maximum frequency</i> . If the reference increases faster than the set acceleration rate, the motor will follow the acceleration rate. If the reference increases slower than the set acceleration rate, the motor frequency will follow the reference. If the acceleration time is set too short, the drive will automatically prolong the acceleration in order not to exceed the drive torque limits.	3.000 s
	0.000...1800.000 s	Acceleration time 1.	10 = 1 s
28.73	<i>Freq deceleration time 1</i>	Defines deceleration time 1 as the time required for the frequency to change from the frequency defined by parameter 46.02 <i>Frequency scaling</i> (not from parameter 30.14 <i>Maximum frequency</i>) to zero. If there is any doubt about the deceleration time being too short, ensure that DC overvoltage control (30.30 <i>Overvoltage control</i>) is on. Note: If a short deceleration time is needed for a high inertia application, the drive should be equipped with braking equipment such as a brake chopper and brake resistor.	3.000 s
	0.000...1800.000 s	Deceleration time 1.	10 = 1 s
28.74	<i>Freq acceleration time 2</i>	Defines acceleration time 2. See parameter 28.72 <i>Freq acceleration time 1</i> .	60.000 s
	0.000...1800.000 s	Acceleration time 2.	10 = 1 s

202 Parameters

No.	Name/Value	Description	Default FbEq 16
28.75	<i>Freq deceleration time 2</i>	Defines deceleration time 2. See parameter 28.73 <i>Freq deceleration time 1</i> .	60.000 s
	0.000...1800.000 s	Deceleration time 2.	10 = 1 s
28.76	<i>Freq ramp in zero source</i>	Selects a source that forces the frequency reference to zero. 0 = Force frequency reference to zero 1 = Normal operation	<i>Inactive</i>
	Active	0.	0
	Inactive	1.	1
	DI1	Digital input DI1 (<i>10.02 DI delayed status</i> , bit 0).	2
	DI2	Digital input DI2 (<i>10.02 DI delayed status</i> , bit 1).	3
	DI3	Digital input DI3 (<i>10.02 DI delayed status</i> , bit 2).	4
	DI4	Digital input DI4 (<i>10.02 DI delayed status</i> , bit 3).	5
	DI5	Digital input DI5 (<i>10.02 DI delayed status</i> , bit 4).	6
	<i>Other [bit]</i>	Source selection (see <i>Terms and abbreviations</i>).	-

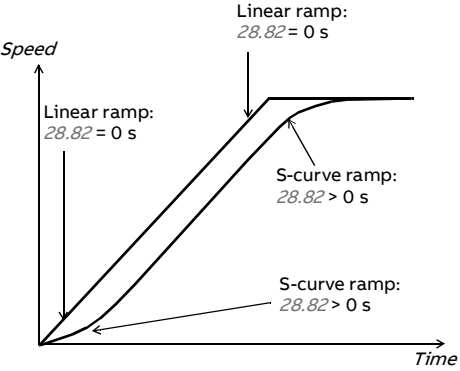
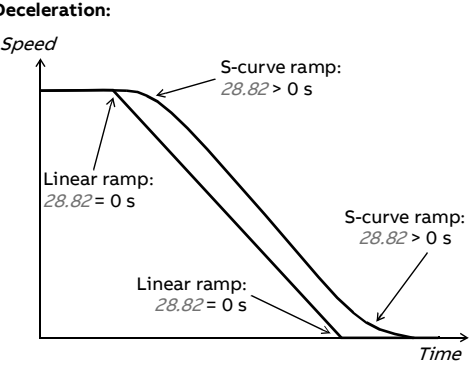



No.	Name/Value	Description	Default FbEq 16
28.82	<i>Shape time 1</i>	<p>Defines the shape of the acceleration and deceleration ramps used with the set 1.</p> <p>0.000 s: Linear ramp. Suitable for steady acceleration or deceleration and for slow ramps.</p> <p>0.001...1000.000 s: S-curve ramp. S-curve ramps are ideal for lifting applications. The S-curve consists of symmetrical curves at both ends of the ramp and a linear part in between.</p> <p>Acceleration:</p>  <p>Deceleration:</p> 	0.000 s
	0.000...1800.000 s	Ramp shape at start and end of acceleration and deceleration.	10 = 1 s
28.83	<i>Shape time 2</i>	Defines the shape of the acceleration and deceleration ramps used with the set 2. See parameter <i>28.82 Shape time 1</i> .	0.000 s
	0.000...1800.000 s	Ramp shape at start and end of acceleration and deceleration.	10 = 1 s



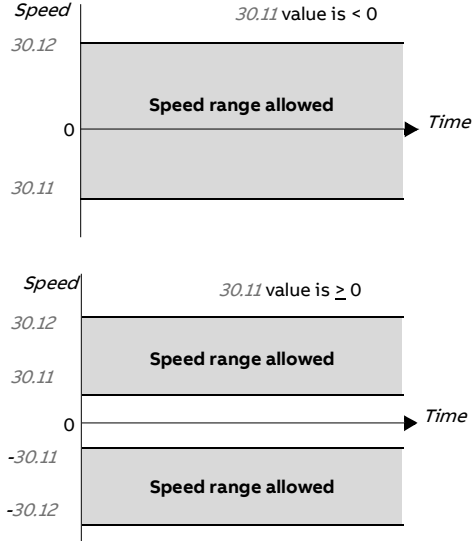

No.	Name/Value	Description	Default FbEq 16
28.92	<i>Frequency ref act 3</i>	Displays the frequency reference after the function applied by parameter <i>28.13 Ext1 frequency function</i> (if any), and after selection (<i>19.11 Ext1/Ext2 selection</i>). See the control chain diagram on page 406. This parameter is read-only.	0.00 Hz
	-500.00...500.00 Hz	Frequency reference after selection.	See par. 46.02
28.96	<i>Frequency ref act 7</i>	Displays the frequency reference after application of constant frequencies, control panel reference, etc. See the control chain diagram on page 406. This parameter is read-only.	0.00 Hz
	-500.00...500.00 Hz	Frequency reference 7.	See par. 46.02
28.97	<i>Frequency ref unlimited</i>	Displays the frequency reference after application of critical frequencies, but before ramping and limiting. See the control chain diagram on page 406. This parameter is read-only.	0.00 Hz
	-500.00...500.00 Hz	Frequency reference before ramping and limiting.	See par. 46.02

30 Limits		Drive operation limits.	
30.01	<i>Limit word 1</i>	Displays limit word 1. This parameter is read-only.	-
Bit	Name	Description	
0	Torq lim	1 = Drive torque is being limited by the motor control (undervoltage control, current control, load angle control or pull-out control), or by the torque limits defined by parameters.	
1...2	Reserved		
3	Torq ref max	1 = Torque reference is being limited by <i>26.09 Maximum torque ref</i> or <i>30.20 Maximum torque 1</i>	
4	Torq ref min	1 = Torque reference is being limited by <i>26.08 Minimum torque ref</i> or <i>30.19 Minimum torque 1</i>	
5	Tlim max speed	1 = Torque reference is being limited by the rush control because of maximum speed limit (<i>30.12 Maximum speed</i>)	
6	Tlim min speed	1 = Torque reference is being limited by the rush control because of minimum speed limit (<i>30.11 Minimum speed</i>)	
7	Max speed ref lim	1 = Speed reference is being limited by <i>30.12 Maximum speed</i>	
8	Min speed ref lim	1 = Speed reference is being limited by <i>30.11 Minimum speed</i>	
9	Max freq ref lim	1 = Frequency reference is being limited by <i>30.14 Maximum frequency</i>	
10	Min freq ref lim	1 = Frequency reference is being limited by <i>30.13 Minimum frequency</i>	
11...15	Reserved		
0000h...FFFFh		Limit word 1.	1 = 1

No.	Name/Value	Description	Default FbEq 16
30.02	<i>Torque limit status</i>	Displays the torque controller limitation status word. This parameter is read-only.	-
Bit	Name	Description	
0	Undervoltage	*1 = Intermediate DC circuit undervoltage	
1	Overvoltage	*1 = Intermediate DC circuit overvoltage	
2	Minimum torque	*1 = Torque is being limited by <i>30.19 Minimum torque 1</i> , <i>30.26 Power motoring limit</i> or <i>30.27 Power generating limit</i>	
3	Maximum torque	*1 = Torque is being limited by <i>30.20 Maximum torque 1</i> , <i>30.26 Power motoring limit</i> or <i>30.27 Power generating limit</i>	
4	Internal current	1 = An inverter current limit (identified by bits 8...11) is active	
5	Load angle	(With permanent magnet motors and reluctance motors only) 1 = Load angle limit is active, ie. the motor cannot produce any more torque	
6	Motor pullout	(With asynchronous motors only) 1 = Motor pull-out limit is active, ie. the motor cannot produce any more torque	
7	Reserved		
8	Thermal	1 = Input current is being limited by the main circuit thermal limit	
9	Max current	*1 = Maximum output current (I_{MAX}) is being limited	
10	User current	*1 = Output current is being limited by <i>30.17 Maximum current</i>	
11	Thermal IGBT	*1 = Output current is being limited by a calculated thermal current value	
12	IGBT overtemperature	*1 = Output current is being limited because of the estimated IGBT temperature	
13	IGBT overload	*1 = Output current is being limited because of the IGBT junction to case temperature	
14...15	Reserved		
*Only one out of bits 0...3, and one out of bits 9...11 can be on simultaneously. The bit typically indicates the limit that is exceeded first.			
0000h...FFFFh		Torque limitation status word.	1 = 1

206 Parameters

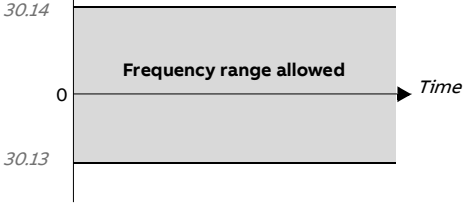
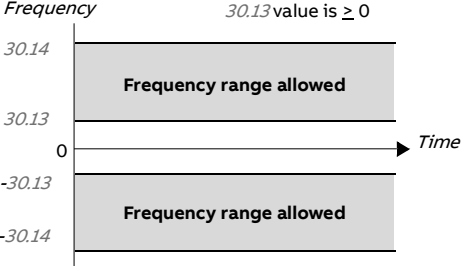
No.	Name/Value	Description	Default FbEq 16
30.11	<i>Minimum speed</i>	<p>Defines together with 30.12 <i>Maximum speed</i> allowed speed range. See the figure below.</p> <p>A positive (or zero) minimum speed value defines two ranges, one positive and one negative.</p> <p>A negative minimum speed value defines one range.</p> <p> WARNING! The absolute value of 30.11 <i>Minimum speed</i> must not be higher than the 30.12 <i>Maximum speed</i>.</p> <p> WARNING! In speed control mode only. In frequency control mode, use frequency limits (30.13 and 30.14).</p> 	-1500.00 rpm
	-30000.00...30000.0 0 rpm	Minimum allowed speed.	See par. 46.01
30.12	<i>Maximum speed</i>	<p>Defines together with 30.11 <i>Minimum speed</i> allowed speed range. See parameter 30.11 <i>Minimum speed</i>.</p> <p>Note: This parameter does not affect the speed acceleration and deceleration ramp times. See parameter 46.01 <i>Speed scaling</i>.</p> <p> WARNING! The absolute value of 30.12 <i>Maximum speed</i> must not be lower than 30.11 <i>Minimum speed</i>.</p> <p> WARNING! In speed control mode only. In frequency control mode, use frequency limits (30.13 and 30.14).</p>	1500.00 rpm
	-30000.00... 30000.00 rpm	Maximum speed.	See par. 46.01

No.	Name/Value	Description	Default FbEq 16
30.13	<i>Minimum frequency</i>	<p>Defines together with 30.14 <i>Maximum frequency</i> allowed frequency range. See the figure below.</p> <p>A positive (or zero) minimum frequency value defines two ranges, one positive and one negative.</p> <p>A negative minimum frequency value defines one range.</p> <p> WARNING! The absolute value of 30.13 <i>Minimum frequency</i> must not be higher than 30.14 <i>Maximum frequency</i>.</p> <p> WARNING! in frequency control mode only.</p> <p><i>Frequency</i> <i>30.13</i> value is < 0</p>  <p><i>Frequency</i> <i>30.13</i> value is ≥ 0</p> 	-50.00 Hz
	-500.00...500.00 Hz	Minimum frequency.	See par. 46.02
30.14	<i>Maximum frequency</i>	<p>Defines together with 30.13 <i>Minimum frequency</i> allowed frequency range. See 30.13 <i>Minimum frequency</i>.</p> <p>Note: This parameter does not affect the speed acceleration and deceleration ramp times. See parameter 46.02 <i>Frequency scaling</i>.</p> <p> WARNING! This absolute value of 30.14 <i>Maximum frequency</i> must not be lower than 30.13 <i>Minimum frequency</i>.</p> <p> WARNING! In frequency control mode only.</p>	50.00 Hz
	-500.00...500.00 Hz	Maximum frequency.	See par. 46.02

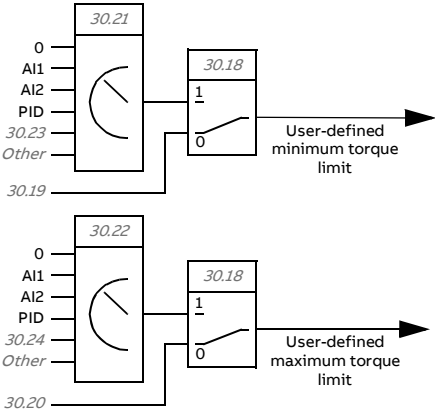
No.	Name/Value	Description	Default FbEq 16
30.17	<i>Maximum current</i>	Defines the maximum allowed motor current. The system sets the default value to 90% of the rated current. If required, you can increase the parameter value by 10%. Note: The maximum current range and default value depends on the drive type.	2.88 A
	0.00...3.20 A	Maximum motor current.	1 = 1 A
30.18	<i>Torq lim sel</i>	Selects a source that switches between two different predefined minimum torque limit sets. 0 = minimum torque limit defined by 30.19 and maximum torque limit defined by 30.20 are active 1 = minimum torque limit selected by 30.21 and maximum torque limit defined by 30.22 are active The user can define two sets of torque limits, and switch between the sets using a binary source such as a digital input. The first set of limits is defined by parameters 30.19 and 30.20. The second set has selector parameters for both the minimum (30.21) and maximum (30.22) limits that allows the use of a selectable analog source (such as an analog input).	<i>Torque limit set 1</i>
	Torque limit set 1		0
	Torque limit set 2	Note: In addition to the user-defined limits, torque may be limited for other reasons (such as power limitation). Refer to the block diagram on page 401.	1
	DI1	Digital input DI1 (10.02 DI delayed status, bit 0).	2
	DI2	Digital input DI2 (10.02 DI delayed status, bit 1).	3
	DI3	Digital input DI3 (10.02 DI delayed status, bit 2).	4
	DI4	Digital input DI4 (10.02 DI delayed status, bit 3).	5
	DI5	Digital input DI5 (10.02 DI delayed status, bit 4).	6



No.	Name/Value	Description	Default FbEq 16
	EFB	Only for the DCU profile. DCU control word bit 15 received through the embedded fieldbus interface.	11
	<i>Other [bit]</i>	Source selection (see <i>Terms and abbreviations</i>).	-
30.19	<i>Minimum torque 1</i>	Defines a minimum torque limit for the drive (in percent of nominal motor torque). See diagram at parameter <i>30.18 Torq lim sel</i> . The limit is effective when <ul style="list-style-type: none"> the source selected by <i>30.18 Torq lim sel</i> is 0, or <i>30.18</i> is set to <i>Torque limit set 1</i>.  WARNING! Do not use minimum torque to stop reverse rotation of the motor. Usage of minimum torque limits disables the drive to reach zero speed and fails to stop the motor.	-300.0%
	-1600.0...0.0%	Minimum torque limit 1.	See par. 46.03
30.20	<i>Maximum torque 1</i>	Defines a maximum torque limit for the drive (in percent of nominal motor torque). See diagram at parameter <i>30.18 Torq lim sel</i> . The limit is effective when <ul style="list-style-type: none"> the source selected by <i>30.18 Torq lim sel</i> is 0, or <i>30.18</i> is set to <i>Torque limit set 1</i>. 	300.0%
	0.0...1600.0%	Maximum torque 1.	See par. 46.03
30.21	<i>Min torque 2 source</i>	Defines the source of the minimum torque limit for the drive (in percent of nominal motor torque) when <ul style="list-style-type: none"> the source selected by parameter <i>30.18 Torq lim sel</i> is 1, or <i>30.18</i> is set to <i>Torque limit set 2</i>. See diagram at <i>30.18 Torq lim sel</i> . Note: Any positive values received from the selected source are inverted.	<i>Minimum torque 2</i>
	Zero	None.	0
	AI1 scaled	<i>12.12 AI1 scaled value</i> (see page 137).	1
	AI2 scaled	<i>12.22 AI2 scaled value</i> (see page 139).	2
	PID	<i>40.01 Process PID output actual</i> (output of the process PID controller).	15
	Minimum torque 2	<i>30.23 Minimum torque 2</i> .	16
	<i>Other</i>	Source selection (see <i>Terms and abbreviations</i>).	-
30.22	<i>Max torque 2 source</i>	Defines the source of the maximum torque limit for the drive (in percent of nominal motor torque) when <ul style="list-style-type: none"> the source selected by parameter <i>30.18 Torq lim sel</i> is 1, or <i>30.18</i> is set to <i>Torque limit set 2</i>. See diagram at <i>30.18 Torq lim sel</i> . Note: Any negative values received from the selected source are inverted.	<i>Maximum torque 2</i>
	Zero	None.	0
	AI1 scaled	<i>12.12 AI1 scaled value</i> (see page 137).	1
	AI2 scaled	<i>12.22 AI2 scaled value</i> (see page 139).	2
	PID	<i>40.01 Process PID output actual</i> (output of the process PID controller).	15

210 Parameters

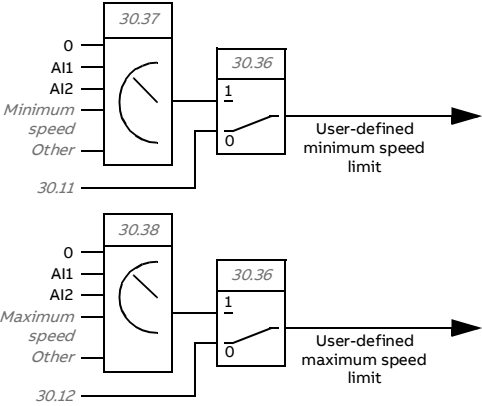
No.	Name/Value	Description	Default FbEq 16
	Maximum torque 2	<i>30.24 Maximum torque 2.</i>	16
	<i>Other</i>	Source selection (see <i>Terms and abbreviations</i>).	-
30.23	<i>Minimum torque 2</i>	Defines the minimum torque limit for the drive (in percent of nominal motor torque) when <ul style="list-style-type: none"> the source selected by <i>30.18 Torq lim sel</i> is 1, or <i>30.18</i> is set to <i>Torque limit set 2</i> and <i>30.21 Min torque 2 source</i> is set to <i>Minimum torque 2</i> See diagram at <i>30.18 Torq lim sel</i> .	-300.0%
	-1600.0...0.0%	Minimum torque limit 2.	See par. <i>46.03</i>
30.24	<i>Maximum torque 2</i>	Defines the maximum torque limit for the drive (in percent of nominal motor torque) when <ul style="list-style-type: none"> the source selected by <i>30.18 Torq lim sel</i> is 1, or <i>30.18</i> is set to <i>Torque limit set 2</i> and <i>30.22 Max torque 2 source</i> is set to <i>Maximum torque 2</i> See diagram at <i>30.18 Torq lim sel</i> .	300.0%
	0.0...1600.0%	Maximum torque limit 2.	See par. <i>46.03</i>
30.26	<i>Power motoring limit</i>	Defines the maximum allowed power fed by the inverter to the motor in percent of nominal motor power.	300.00%
	0.00...600.00%	Maximum motoring power.	1 = 1%
30.27	<i>Power generating limit</i>	Defines the maximum allowed power fed by the motor to the inverter in percent of nominal motor power.	-300.00%
	-600.00...0.00%	Maximum generating power.	1 = 1%
30.30	<i>Overvoltage control</i>	Enables the overvoltage control of the intermediate DC link. Fast braking of a high inertia load causes the voltage to rise to the overvoltage control limit. To prevent the DC voltage from exceeding the limit, the overvoltage controller automatically decreases the braking torque. Note: If the drive is equipped with a brake chopper and resistor, or a regenerative supply unit, the controller must be disabled.	<i>Enable</i>
	Disable	Overvoltage control disabled.	0
	Enable	Overvoltage control enabled.	1
30.31	<i>Undervoltage control</i>	Enables the undervoltage control of the intermediate DC link. If the DC voltage drops due to input power cut off, the undervoltage controller will automatically decrease the motor torque in order to keep the voltage above the lower limit. By decreasing the motor torque, the inertia of the load will cause regeneration back to the drive, keeping the DC link charged and preventing an undervoltage trip until the motor coasts to a stop. This will act as a power-loss ride-through functionality in systems with high inertia, such as a centrifuge or a fan.	<i>Enable</i>
	Disable	Undervoltage control disabled.	0

No.	Name/Value	Description	Default FbEq 16
	Enable	Undervoltage control enabled.	1
30.35	<i>Thermal current limitation</i>	Enables/disables temperature-based output current limitation. The limitation should only be disabled if required by the application.	<i>Enable</i>
	Disable	Thermal current limitation disabled.	0
	Enable	Thermal current limitation enabled.	1
30.36	<i>Speed limit selection</i>	<p>Selects a source that switches between two different predefined adjustable speed limit sets. 0 = minimum speed limit defined by 30.11 and maximum speed limit defined by 30.12 are active 1 = minimum speed limit selected by 30.37 and maximum speed limit defined by 30.38 are active. The user can define two sets of speed limits, and switch between the sets using a binary source such as a digital input.</p> <p>The first set of limits is defined by parameters 30.11 <i>Minimum speed</i> and 30.12 <i>Maximum speed</i>. The second set has selector parameters for both the minimum (30.37) and maximum (30.38) limits that allows the use of a selectable analog source (such as an analog input).</p> 	<i>Not selected</i>
	Not selected	Adjustable speed limits are disabled. (Minimum speed limit defined by 30.11 <i>Minimum speed</i> and maximum speed limit defined by 30.12 <i>Maximum speed</i> are active).	0
	Selected	Adjustable speed limits are enabled. (Minimum speed limit defined by 30.37 <i>Min speed source</i> and maximum speed limit defined by 30.38 <i>Max speed source</i> are active).	1
	Ext1 active	Adjustable speed limits are enabled if EXT1 is active.	2
	Ext2 active	Adjustable speed limits are enabled if EXT2 is active.	3

212 Parameters

No.	Name/Value	Description	Default FbEq 16
	Torque control	Adjustable speed limits are enabled if Torque control mode (vector motor control) is active.	4
	DI1	Digital input DI1 (10.02 DI delayed status, bit 0).	5
	DI2	Digital input DI2 (10.02 DI delayed status, bit 1).	6
	DI3	Digital input DI2 (10.02 DI delayed status, bit 2).	7
	DI4	Digital input DI2 (10.02 DI delayed status, bit 3).	8
	DI5	Digital input DI2 (10.02 DI delayed status, bit 4).	9
	<i>Other [bit]</i>	Source selection (see <i>Terms and abbreviations</i>).	-
30.37	<i>Min speed source</i>	Defines the source of a minimum speed limit for the drive when the source is selected by 30.36 Speed limit selection.  WARNING! In vector motor control mode only. In scalar motor control mode, use frequency limits 30.13 and 30.14.	<i>Minimum speed</i>
	Zero	None.	0
	AI1 scaled	12.12 AI1 scaled value	1
	AI2 scaled	12.22 AI2 scaled value	2
	Minimum speed	30.11 Minimum speed.	11
	<i>Other</i>	Source selection (see <i>Terms and abbreviations</i>).	-
30.38	<i>Max speed source</i>	Defines the source of a maximum speed limit for the drive when the source is selected by 30.36 Speed limit selection.  WARNING! In vector motor control mode only. In scalar motor control mode, use frequency limits 30.13 and 30.14.	<i>Maximum speed</i>
	Zero	None.	0
	AI1 scaled	12.12 AI1 scaled value	1
	AI2 scaled	12.22 AI2 scaled value	2
	Maximum speed	30.12 Maximum speed.	12
	<i>Other</i>	Source selection (see <i>Terms and abbreviations</i>).	-
31 Fault functions		Configuration of external events; selection of behavior of the drive upon fault situations.	
31.01	<i>External event 1 source</i>	Defines the source of external event 1. See also parameter 31.02 External event 1 type. 0 = Trigger event 1 = Normal operation	<i>Inactive (true)</i>
	Active (false)	0.	0
	Inactive (true)	1.	1
	DI1	Digital input DI1 (10.02 DI delayed status, bit 0).	3
	DI2	Digital input DI2 (10.02 DI delayed status, bit 1).	4
	DI3	Digital input DI3 (10.02 DI delayed status, bit 2).	5
	DI4	Digital input DI4 (10.02 DI delayed status, bit 3).	6
	DI5	Digital input DI5 (10.02 DI delayed status, bit 4).	7
	<i>Other [bit]</i>	Source selection (see <i>Terms and abbreviations</i>).	-

No.	Name/Value	Description	Default FbEq 16
31.02	<i>External event 1 type</i>	Selects the type of external event 1.	<i>Fault</i>
	Fault	The external event generates a fault.	0
	Warning	The external event generates a warning.	1
31.03	<i>External event 2 source</i>	Defines the source of external event 2. See also parameter 31.04 <i>External event 2 type</i> . For the selections, see parameter 31.01 <i>External event 1 source</i> .	<i>Inactive (true)</i>
31.04	<i>External event 2 type</i>	Selects the type of external event 2.	<i>Fault</i>
	Fault	The external event generates a fault.	0
	Warning	The external event generates a warning.	1
31.05	<i>External event 3 source</i>	Defines the source of external event 3. See also parameter 31.06 <i>External event 3 type</i> . For the selections, see parameter 31.01 <i>External event 1 source</i> .	<i>Inactive (true)</i>
31.06	<i>External event 3 type</i>	Selects the type of external event 3.	
	Fault	The external event generates a fault.	0
	Warning	The external event generates a warning.	1
31.07	<i>External event 4 source</i>	Defines the source of external event 4. See also parameter 31.08 <i>External event 4 type</i> . For the selections, see parameter 31.01 <i>External event 1 source</i> .	<i>Inactive (true)</i>
31.08	<i>External event 4 type</i>	Selects the type of external event 4.	
	Fault	The external event generates a fault.	0
	Warning	The external event generates a warning.	1
31.09	<i>External event 5 source</i>	Defines the source of external event 5. See also parameter 31.10 <i>External event 5 type</i> . For the selections, see parameter 31.01 <i>External event 1 source</i> .	<i>Inactive (true)</i>
31.10	<i>External event 5 type</i>	Selects the type of external event 5.	<i>Fault</i>
	Fault	The external event generates a fault.	0
	Warning	The external event generates a warning.	1
31.11	<i>Fault reset selection</i>	Selects the source of an external fault reset signal. The signal resets the drive after a fault trip if the cause of the fault no longer exists. 0 -> 1 = Reset Note: A fault reset via FBA A and EFB MCW bit 7 is useful when the start stop signal is through DIs (parameter 20.01 or 20.06) or from local control mode and the user wants a fault reset through the fieldbus. Whenever the remote control mode is in fieldbus (Start stop command and reference is through fieldbus), the fault can be reset from the fieldbus regardless of the selection of the parameter.	<i>Not used</i>
	Not used	Not used	0
	Not used	Not used	1
	DI1	Digital input DI1 (10.02 <i>DI delayed status</i> , bit 0).	2
	DI2	Digital input DI2 (10.02 <i>DI delayed status</i> , bit 1).	3

214 Parameters

No.	Name/Value	Description	Default FbEq 16																								
	DI3	Digital input DI3 (<i>10.02 DI delayed status</i> , bit 2).	4																								
	DI4	Digital input DI4 (<i>10.02 DI delayed status</i> , bit 3).	5																								
	DI5	Digital input DI5 (<i>10.02 DI delayed status</i> , bit 4).	6																								
	Supervision 1	Bit 0 of <i>32.01 Supervision status</i> .	24																								
	Supervision 2	Bit 1 of <i>32.01 Supervision status</i> .	25																								
	Supervision 3	Bit 2 of <i>32.01 Supervision status</i> .	26																								
	Supervision 4	Bit 3 of <i>32.01 Supervision status</i> .	27																								
	Supervision 5	Bit 4 of <i>32.01 Supervision status</i> .	28																								
	Supervision 6	Bit 5 of <i>32.01 Supervision status</i> .	29																								
	EFB MCW bit 7	Control word bit 7 received through the embedded fieldbus interface.	32																								
	<i>Other [bit]</i>	Source selection (see <i>Terms and abbreviations</i>).	-																								
31.12	<i>Autoreset selection</i>	<p>Selects faults that are automatically reset. The parameter is a 16-bit word with each bit corresponding to a fault type. Whenever a bit is set to 1, the corresponding fault is automatically reset. The number and interval of reset attempts are defined by parameters <i>31.14...31.16</i>.</p> <p> WARNING! Before you activate the function, make sure that no dangerous situations can occur. The function resets the drive automatically and continues operation after a fault.</p> <p>Notes:</p> <ul style="list-style-type: none"> The autoreset function is only available in external control; see section <i>Local and external control locations</i> (page 46). Faults related to the Safe torque off (STO) function cannot be automatically reset. <p>The bits of this binary number correspond to the following faults:</p> <table border="1" data-bbox="165 1002 972 1276"> <thead> <tr> <th>Bit</th> <th>Fault</th> </tr> </thead> <tbody> <tr> <td>0</td> <td>Overcurrent</td> </tr> <tr> <td>1</td> <td>Overvoltage</td> </tr> <tr> <td>2</td> <td>Undervoltage</td> </tr> <tr> <td>3</td> <td>AI supervision fault</td> </tr> <tr> <td>4...9</td> <td>Reserved</td> </tr> <tr> <td>10</td> <td>Selectable fault (see parameter <i>31.13 Selectable fault</i>)</td> </tr> <tr> <td>11</td> <td>External fault 1 (from source selected by parameter <i>31.01 External event 1 source</i>)</td> </tr> <tr> <td>12</td> <td>External fault 2 (from source selected by parameter <i>31.03 External event 2 source</i>)</td> </tr> <tr> <td>13</td> <td>External fault 3 (from source selected by parameter <i>31.05 External event 3 source</i>)</td> </tr> <tr> <td>14</td> <td>External fault 4 (from source selected by parameter <i>31.07 External event 4 source</i>)</td> </tr> <tr> <td>15</td> <td>External fault 5 (from source selected by parameter <i>31.09 External event 5 source</i>)</td> </tr> </tbody> </table>	Bit	Fault	0	Overcurrent	1	Overvoltage	2	Undervoltage	3	AI supervision fault	4...9	Reserved	10	Selectable fault (see parameter <i>31.13 Selectable fault</i>)	11	External fault 1 (from source selected by parameter <i>31.01 External event 1 source</i>)	12	External fault 2 (from source selected by parameter <i>31.03 External event 2 source</i>)	13	External fault 3 (from source selected by parameter <i>31.05 External event 3 source</i>)	14	External fault 4 (from source selected by parameter <i>31.07 External event 4 source</i>)	15	External fault 5 (from source selected by parameter <i>31.09 External event 5 source</i>)	0000h
Bit	Fault																										
0	Overcurrent																										
1	Overvoltage																										
2	Undervoltage																										
3	AI supervision fault																										
4...9	Reserved																										
10	Selectable fault (see parameter <i>31.13 Selectable fault</i>)																										
11	External fault 1 (from source selected by parameter <i>31.01 External event 1 source</i>)																										
12	External fault 2 (from source selected by parameter <i>31.03 External event 2 source</i>)																										
13	External fault 3 (from source selected by parameter <i>31.05 External event 3 source</i>)																										
14	External fault 4 (from source selected by parameter <i>31.07 External event 4 source</i>)																										
15	External fault 5 (from source selected by parameter <i>31.09 External event 5 source</i>)																										
	0000h...FFFFh	Automatic reset configuration word.	1 = 1																								

No.	Name/Value	Description	Default FbEq 16
31.13	Selectable fault	Defines the fault that can be automatically reset using parameter <i>31.12 Autoreset selection</i> , bit 10. Faults are listed in chapter <i>Fault tracing</i> (page 353). Note: The fault codes are in hexadecimal. The selected code must be converted to decimal for this parameter.	0
	0000h...FFFFh	Fault code.	10 = 1
31.14	Number of trials	Defines the maximum number of automatic resets that the drive is allowed to attempt within the time defined by parameter <i>31.15 Total trials time</i> . If the fault persists, subsequent reset attempts will be made at intervals defined by <i>31.16 Delay time</i> . The faults to be automatically reset are defined by <i>31.12 Autoreset selection</i> .	0
	0...5	Number of automatic resets.	10 = 1
31.15	Total trials time	Defines a time window for automatic fault resets. The maximum number of attempts made during any period of this length is defined by <i>31.14 Number of trials</i> . Note: If the fault condition remains and cannot be reset, each reset attempt will generate an event and start a new time window. In practice, if the specified number of resets (<i>31.14</i>) at specified intervals (<i>31.16</i>) take longer than the value of <i>31.15</i> , the drive will continue to attempt resetting the fault until the cause is eventually removed.	30.0 s
	1.0...600.0 s	Time for automatic resets.	10 = 1 s
31.16	Delay time	Defines the time that the drive will wait after a fault before attempting an automatic reset. See parameter <i>31.12 Autoreset selection</i> .	0.0 s
	0.0...120.0 s	Autoreset delay.	10 = 1 s
31.19	Motor phase loss	Selects how the drive reacts when a motor phase loss is detected. See section <i>Motor phase loss detection</i> (parameter <i>31.19</i>) on page 97.	Fault
	No action	No action taken.	0
	Fault	The drive trips on fault <i>3381 Output phase loss</i> .	1
31.20	Earth fault	Selects how the drive reacts when an earth (ground) fault or current unbalance is detected in the motor or the motor cable.	Fault
	No action	No action taken.	0
	Warning	The drive generates an <i>A2B3 Earth leakage</i> warning.	1
	Fault	The drive trips on fault <i>2330 Earth leakage</i> .	2
31.21	Supply phase loss	Selects how the drive reacts when a supply phase loss is detected.	Fault
	No action	No action taken. Note: When this option is selected, the drive will eventually overheat or the supply bridge may be damaged if one supply phase is lost, unless 50% derating is done when dimensioning the system.	0
	Fault	The drive trips on fault <i>3130 Input phase loss</i> .	1

No.	Name/Value	Description	Default FbEq 16																								
31.22	<i>STO indication run/stop</i>	<p>Selects which indications are given when one or both Safe torque off (STO) signals are switched off or lost. The indications also depend on whether the drive is running or stopped when this occurs. The tables at each selection below show the indications generated with that particular setting.</p> <p>Notes:</p> <ul style="list-style-type: none"> This parameter does not affect the operation of the STO function itself. The STO function will operate regardless of the setting of this parameter: a running drive will stop upon removal of one or both STO signals, and will not start until both STO signals are restored and all faults reset. The loss of only one STO signal always generates a fault as it is interpreted as a malfunction. <p>For more information on the STO, see chapter <i>The Safe torque off function</i> in the hardware manual of the drive.</p>	<i>Fault/Fault</i>																								
	Fault/Fault	<table border="1" data-bbox="370 635 841 772"> <thead> <tr> <th colspan="2">Inputs</th> <th rowspan="2">Indication (running or stopped)</th> </tr> <tr> <th>IN1</th> <th>IN2</th> </tr> </thead> <tbody> <tr> <td>0</td> <td>0</td> <td>Fault 5091 Safe torque off</td> </tr> <tr> <td>0</td> <td>1</td> <td>Fault FA81 Safe torque off 1</td> </tr> <tr> <td>1</td> <td>0</td> <td>Fault FA82 Safe torque off 2</td> </tr> <tr> <td>1</td> <td>1</td> <td>(Normal operation)</td> </tr> </tbody> </table>	Inputs		Indication (running or stopped)	IN1	IN2	0	0	Fault 5091 Safe torque off	0	1	Fault FA81 Safe torque off 1	1	0	Fault FA82 Safe torque off 2	1	1	(Normal operation)	0							
Inputs		Indication (running or stopped)																									
IN1	IN2																										
0	0	Fault 5091 Safe torque off																									
0	1	Fault FA81 Safe torque off 1																									
1	0	Fault FA82 Safe torque off 2																									
1	1	(Normal operation)																									
	Fault/Warning	<table border="1" data-bbox="370 858 841 1059"> <thead> <tr> <th colspan="2">Inputs</th> <th colspan="2">Indication</th> </tr> <tr> <th>IN1</th> <th>IN2</th> <th>Running</th> <th>Stopped</th> </tr> </thead> <tbody> <tr> <td>0</td> <td>0</td> <td>Fault 5091 Safe torque off</td> <td>Warning A5A0 Safe torque off</td> </tr> <tr> <td>0</td> <td>1</td> <td>Fault FA81 Safe torque off 1</td> <td>Fault FA81 Safe torque off 1</td> </tr> <tr> <td>1</td> <td>0</td> <td>Fault FA82 Safe torque off 2</td> <td>Fault FA82 Safe torque off 2</td> </tr> <tr> <td>1</td> <td>1</td> <td colspan="2">(Normal operation)</td> </tr> </tbody> </table>	Inputs		Indication		IN1	IN2	Running	Stopped	0	0	Fault 5091 Safe torque off	Warning A5A0 Safe torque off	0	1	Fault FA81 Safe torque off 1	Fault FA81 Safe torque off 1	1	0	Fault FA82 Safe torque off 2	Fault FA82 Safe torque off 2	1	1	(Normal operation)		1
Inputs		Indication																									
IN1	IN2	Running	Stopped																								
0	0	Fault 5091 Safe torque off	Warning A5A0 Safe torque off																								
0	1	Fault FA81 Safe torque off 1	Fault FA81 Safe torque off 1																								
1	0	Fault FA82 Safe torque off 2	Fault FA82 Safe torque off 2																								
1	1	(Normal operation)																									
	Fault/Event	<table border="1" data-bbox="370 1145 841 1347"> <thead> <tr> <th colspan="2">Inputs</th> <th colspan="2">Indication</th> </tr> <tr> <th>IN1</th> <th>IN2</th> <th>Running</th> <th>Stopped</th> </tr> </thead> <tbody> <tr> <td>0</td> <td>0</td> <td>Fault 5091 Safe torque off</td> <td>Event B5A0 Safe torque off</td> </tr> <tr> <td>0</td> <td>1</td> <td>Fault FA81 Safe torque off 1</td> <td>Fault FA81 Safe torque off 1</td> </tr> <tr> <td>1</td> <td>0</td> <td>Fault FA82 Safe torque off 2</td> <td>Fault FA82 Safe torque off 2</td> </tr> <tr> <td>1</td> <td>1</td> <td colspan="2">(Normal operation)</td> </tr> </tbody> </table>	Inputs		Indication		IN1	IN2	Running	Stopped	0	0	Fault 5091 Safe torque off	Event B5A0 Safe torque off	0	1	Fault FA81 Safe torque off 1	Fault FA81 Safe torque off 1	1	0	Fault FA82 Safe torque off 2	Fault FA82 Safe torque off 2	1	1	(Normal operation)		2
Inputs		Indication																									
IN1	IN2	Running	Stopped																								
0	0	Fault 5091 Safe torque off	Event B5A0 Safe torque off																								
0	1	Fault FA81 Safe torque off 1	Fault FA81 Safe torque off 1																								
1	0	Fault FA82 Safe torque off 2	Fault FA82 Safe torque off 2																								
1	1	(Normal operation)																									

No.	Name/Value	Description	Default FbEq 16																	
	Warning/Warning	<table border="1"> <thead> <tr> <th colspan="2">Inputs</th> <th rowspan="2">Indication (running or stopped)</th> </tr> <tr> <th>IN1</th> <th>IN2</th> </tr> </thead> <tbody> <tr> <td>0</td> <td>0</td> <td>Warning <i>A5A0 Safe torque off</i></td> </tr> <tr> <td>0</td> <td>1</td> <td>Fault <i>FA81 Safe torque off 1</i></td> </tr> <tr> <td>1</td> <td>0</td> <td>Fault <i>FA82 Safe torque off 2</i></td> </tr> <tr> <td>1</td> <td>1</td> <td>(Normal operation)</td> </tr> </tbody> </table>	Inputs		Indication (running or stopped)	IN1	IN2	0	0	Warning <i>A5A0 Safe torque off</i>	0	1	Fault <i>FA81 Safe torque off 1</i>	1	0	Fault <i>FA82 Safe torque off 2</i>	1	1	(Normal operation)	3
Inputs		Indication (running or stopped)																		
IN1	IN2																			
0	0	Warning <i>A5A0 Safe torque off</i>																		
0	1	Fault <i>FA81 Safe torque off 1</i>																		
1	0	Fault <i>FA82 Safe torque off 2</i>																		
1	1	(Normal operation)																		
	Event/Event	<table border="1"> <thead> <tr> <th colspan="2">Inputs</th> <th rowspan="2">Indication (running or stopped)</th> </tr> <tr> <th>IN1</th> <th>IN2</th> </tr> </thead> <tbody> <tr> <td>0</td> <td>0</td> <td>Event <i>B5A0 Safe torque off</i></td> </tr> <tr> <td>0</td> <td>1</td> <td>Event <i>B5A0 Safe torque off and fault FA81 Safe torque off 1</i></td> </tr> <tr> <td>1</td> <td>0</td> <td>Event <i>B5A0 Safe torque off and fault FA82 Safe torque off 2</i></td> </tr> <tr> <td>1</td> <td>1</td> <td>(Normal operation)</td> </tr> </tbody> </table>	Inputs		Indication (running or stopped)	IN1	IN2	0	0	Event <i>B5A0 Safe torque off</i>	0	1	Event <i>B5A0 Safe torque off and fault FA81 Safe torque off 1</i>	1	0	Event <i>B5A0 Safe torque off and fault FA82 Safe torque off 2</i>	1	1	(Normal operation)	4
Inputs		Indication (running or stopped)																		
IN1	IN2																			
0	0	Event <i>B5A0 Safe torque off</i>																		
0	1	Event <i>B5A0 Safe torque off and fault FA81 Safe torque off 1</i>																		
1	0	Event <i>B5A0 Safe torque off and fault FA82 Safe torque off 2</i>																		
1	1	(Normal operation)																		
	No Indication/No Indication	<table border="1"> <thead> <tr> <th colspan="2">Inputs</th> <th rowspan="2">Indication (running or stopped)</th> </tr> <tr> <th>IN1</th> <th>IN2</th> </tr> </thead> <tbody> <tr> <td>0</td> <td>0</td> <td>None</td> </tr> <tr> <td>0</td> <td>1</td> <td>Fault <i>FA81 Safe torque off 1</i></td> </tr> <tr> <td>1</td> <td>0</td> <td>Fault <i>FA82 Safe torque off 2</i></td> </tr> <tr> <td>1</td> <td>1</td> <td>(Normal operation)</td> </tr> </tbody> </table>	Inputs		Indication (running or stopped)	IN1	IN2	0	0	None	0	1	Fault <i>FA81 Safe torque off 1</i>	1	0	Fault <i>FA82 Safe torque off 2</i>	1	1	(Normal operation)	5
Inputs		Indication (running or stopped)																		
IN1	IN2																			
0	0	None																		
0	1	Fault <i>FA81 Safe torque off 1</i>																		
1	0	Fault <i>FA82 Safe torque off 2</i>																		
1	1	(Normal operation)																		
31.23	<i>Wiring or earth fault</i>	Selects how the drive reacts to incorrect input power and motor cable connection (ie. input power cable is connected to drive motor connection).	<i>Fault</i>																	
	No action	No action taken.	0																	
	Fault	The drive trips on fault <i>3181 Cross connection</i> .	1																	
31.24	<i>Stall function</i>	<p>Selects how the drive reacts to a motor stall condition.</p> <p>A stall condition is defined as follows:</p> <ul style="list-style-type: none"> • The drive exceeds the stall current limit (<i>31.25 Stall current limit</i>), and • the output frequency is below the level set by parameter <i>31.27 Stall frequency limit</i> or the motor speed is below the level set by parameter <i>31.26 Stall speed limit</i>, and • the conditions above have been true longer than the time set by parameter <i>31.28 Stall time</i>. 	<i>No action</i>																	
	No action	None (stall supervision disabled).	0																	
	Warning	The drive generates an <i>A780 Motor stall warning</i> .	1																	
	Fault	The drive trips on fault <i>7121 Motor stall</i> .	2																	
31.25	<i>Stall current limit</i>	Stall current limit in percent of the nominal current of the motor. See parameter <i>31.24 Stall function</i> .	200.0%																	
	0.0...1600.0%	Stall current limit.	-																	

218 Parameters

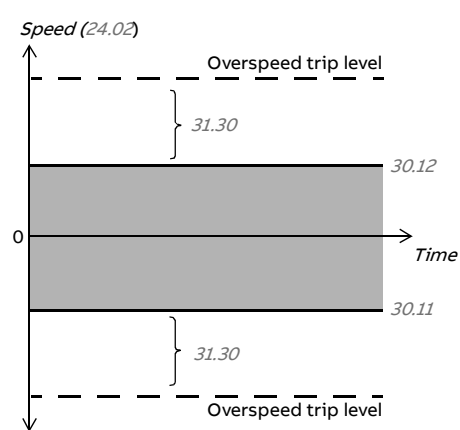
No.	Name/Value	Description	Default FbEq 16
31.26	Stall speed limit	Stall speed limit in rpm. See parameter 31.24 Stall function.	150.00 rpm
	0.00...10000.00 rpm	Stall speed limit.	See par. 46.01
31.27	Stall frequency limit	Stall frequency limit. See parameter 31.24 Stall function. Note: Setting the limit below 10 Hz is not recommended.	15.00 Hz
	0.00...1000.00 Hz	Stall frequency limit.	See par. 46.02
31.28	Stall time	Stall time. See parameter 31.24 Stall function.	20 s
	0...3600 s	Stall time.	-
31.30	Overspeed trip margin	<p>Defines, together with 30.11 Minimum speed and 30.12 Maximum speed, the maximum allowed speed of the motor (overspeed protection). If the speed (24.02 Used speed feedback) exceeds the speed limit defined by parameter 30.11 or 30.12 by more than the value of this parameter, the drive trips on the 7310 Overspeed fault.</p> <p>! WARNING! This function only supervises the speed in vector motor control mode. The function is not effective in scalar motor control mode.</p> <p>Example: If the maximum speed is 1420 rpm and speed trip margin is 300 rpm, the drive trips at 1720 rpm.</p> 	500.00 rpm
	0.00...10000.00 rpm	Overspeed trip margin.	See par. 46.01

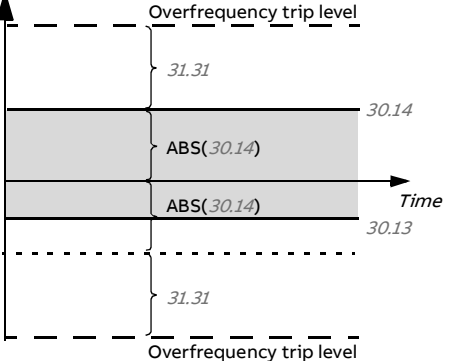
No.	Name/Value	Description	Default FbEq 16
31.31	<i>Frequency trip margin</i>	<p>Defines, together with 30.13 <i>Minimum frequency</i> and 30.14 <i>Maximum frequency</i>, the maximum allowed frequency of the motor (overfrequency protection). The absolute value of this overfrequency trip level is calculated by adding the value of this parameter to the higher of the absolute values of 30.13 <i>Minimum frequency</i> and 30.14 <i>Maximum frequency</i>.</p> <p>If the output frequency (01.06 <i>Output frequency</i>) exceeds the overfrequency trip level (ie. the absolute value of the output frequency exceeds the absolute value of the overfrequency trip level), the drive trips on the 73F0 <i>Overfrequency</i> fault.</p> <p><i>Frequency</i></p>  <p>Overfrequency trip level</p> <p>31.31</p> <p>30.14</p> <p>ABS(30.14)</p> <p>ABS(30.14)</p> <p>Time</p> <p>30.13</p> <p>31.31</p> <p>Overfrequency trip level</p>	15.00 Hz
	0.00...10000.00 Hz	Overfrequency trip margin.	See par. 46.02
31.32	<i>Emergency ramp supervision</i>	<p>Parameters 31.32 <i>Emergency ramp supervision</i> and 31.33 <i>Emergency ramp supervision delay</i>, together with the derivative of 24.02 <i>Used speed feedback</i>, provide a supervision function for emergency stop modes Off1 and Off3.</p> <p>The supervision is based on either</p> <ul style="list-style-type: none"> • observing the time within which the motor stops, or • comparing the actual and expected deceleration rates. <p>If this parameter is set to 0%, the maximum stop time is directly set in parameter 31.33. Otherwise, 31.32 defines the maximum allowed deviation from the expected deceleration rate, which is calculated from parameters 23.11... 23.15 (Off1) or 23.23 <i>Emergency stop time</i> (Off3). If the actual deceleration rate (24.02) deviates too much from the expected rate, the drive trips on 73B0 <i>Emergency ramp failed</i>, sets bit 8 of 06.17 <i>Drive status word 2</i>, and coasts to a stop.</p> <p>If 31.32 is set to 0% and 31.33 is set to 0 s, the emergency stop ramp supervision is disabled. See also parameter 21.04 <i>Emergency stop mode</i>.</p>	0%
	0...300%	Maximum deviation from expected deceleration rate.	1 = 1%

220 Parameters

No.	Name/Value	Description	Default FbEq 16																					
31.33	<i>Emergency ramp supervision delay</i>	<p>If parameter <i>31.32 Emergency ramp supervision</i> is set to 0%, this parameter defines the maximum time an emergency stop (mode Off1 or Off3) is allowed to take. If the motor has not stopped when the time elapses, the drive trips on <i>73B0 Emergency ramp failed</i>, sets bit 8 of <i>06.17 Drive status word 2</i>, and coasts to a stop.</p> <p>If <i>31.32</i> is set to a value other than 0%, this parameter defines a delay between the receipt of the emergency stop command and the activation of the supervision. It is recommended to specify a short delay to allow the speed change rate to stabilize.</p>	0 s																					
	0...100 s	Maximum ramp-down time, or supervision activation delay.	1 = 1 s																					
31.40	<i>Disable warning messages</i>	Selects the warnings to be suppressed. This parameter is a 16-bit word with each bit corresponding to a warning. Whenever a bit is set to 1, the corresponding warning is not logged to event log.	0000h																					
		<table border="1"> <thead> <tr> <th>Bit</th> <th>Name</th> <th>Description</th> </tr> </thead> <tbody> <tr> <td>0</td> <td>Reserved</td> <td></td> </tr> <tr> <td>1</td> <td>DC link undervoltage</td> <td>1 = Warning <i>A3A2 DC link undervoltage</i> is suppressed.</td> </tr> <tr> <td>2...4</td> <td>Reserved</td> <td></td> </tr> <tr> <td>5</td> <td>Emergency stop off2</td> <td>1 = Warning <i>AFE1 Emergency stop (off2)</i> is suppressed.</td> </tr> <tr> <td>4</td> <td>Emergency stop off1, off3</td> <td>1 = Warning <i>AFE2 Emergency stop (off1 or off3)</i> is suppressed.</td> </tr> <tr> <td>7...15</td> <td>Reserved</td> <td>Reserved</td> </tr> </tbody> </table>	Bit	Name	Description	0	Reserved		1	DC link undervoltage	1 = Warning <i>A3A2 DC link undervoltage</i> is suppressed.	2...4	Reserved		5	Emergency stop off2	1 = Warning <i>AFE1 Emergency stop (off2)</i> is suppressed.	4	Emergency stop off1, off3	1 = Warning <i>AFE2 Emergency stop (off1 or off3)</i> is suppressed.	7...15	Reserved	Reserved	
Bit	Name	Description																						
0	Reserved																							
1	DC link undervoltage	1 = Warning <i>A3A2 DC link undervoltage</i> is suppressed.																						
2...4	Reserved																							
5	Emergency stop off2	1 = Warning <i>AFE1 Emergency stop (off2)</i> is suppressed.																						
4	Emergency stop off1, off3	1 = Warning <i>AFE2 Emergency stop (off1 or off3)</i> is suppressed.																						
7...15	Reserved	Reserved																						
	0000h...FFFFh	Word for disabling warnings.	1 = 1																					
31.54	<i>Fault action</i>	Selects the stop mode when a non-critical fault occurs.	Coast																					
	Coast	The drive coasts to stop.	0																					
	Emergency ramp	The drive follows the ramp specified for an emergency stop by parameter <i>23.23</i> .	1																					

No.	Name/Value	Description	Default FbEq 16																								
<i>32 Supervision</i>		Configuration of signal supervision functions 1...3. Three values can be chosen to be monitored; a warning or fault is generated whenever predefined limits are exceeded. See also section <i>Signal supervision</i> (page 99).																									
<i>32.01</i>	<i>Supervision status</i>	Signal supervision status word. Indicates whether the values monitored by the signal supervision functions are within or outside their respective limits. Note: This word is independent of the drive actions defined by parameters <i>32.06</i> , <i>32.16</i> , <i>32.26</i> , <i>32.36</i> , <i>32.46</i> and <i>32.56</i> .	0000h																								
		<table border="1"> <thead> <tr> <th>Bit</th> <th>Name</th> <th>Description</th> </tr> </thead> <tbody> <tr> <td>0</td> <td>Supervision 1 active</td> <td>1 = Signal selected by <i>32.07</i> is outside its limits.</td> </tr> <tr> <td>1</td> <td>Supervision 2 active</td> <td>1 = Signal selected by <i>32.17</i> is outside its limits.</td> </tr> <tr> <td>2</td> <td>Supervision 3 active</td> <td>1 = Signal selected by <i>32.27</i> is outside its limits.</td> </tr> <tr> <td>3</td> <td>Supervision 4 active</td> <td>1 = Signal selected by <i>32.37</i> is outside its limits.</td> </tr> <tr> <td>4</td> <td>Supervision 5 active</td> <td>1 = Signal selected by <i>32.47</i> is outside its limits.</td> </tr> <tr> <td>5</td> <td>Supervision 6 active</td> <td>1 = Signal selected by <i>32.57</i> is outside its limits.</td> </tr> <tr> <td>6...15</td> <td>Reserved</td> <td></td> </tr> </tbody> </table>	Bit	Name	Description	0	Supervision 1 active	1 = Signal selected by <i>32.07</i> is outside its limits.	1	Supervision 2 active	1 = Signal selected by <i>32.17</i> is outside its limits.	2	Supervision 3 active	1 = Signal selected by <i>32.27</i> is outside its limits.	3	Supervision 4 active	1 = Signal selected by <i>32.37</i> is outside its limits.	4	Supervision 5 active	1 = Signal selected by <i>32.47</i> is outside its limits.	5	Supervision 6 active	1 = Signal selected by <i>32.57</i> is outside its limits.	6...15	Reserved		
Bit	Name	Description																									
0	Supervision 1 active	1 = Signal selected by <i>32.07</i> is outside its limits.																									
1	Supervision 2 active	1 = Signal selected by <i>32.17</i> is outside its limits.																									
2	Supervision 3 active	1 = Signal selected by <i>32.27</i> is outside its limits.																									
3	Supervision 4 active	1 = Signal selected by <i>32.37</i> is outside its limits.																									
4	Supervision 5 active	1 = Signal selected by <i>32.47</i> is outside its limits.																									
5	Supervision 6 active	1 = Signal selected by <i>32.57</i> is outside its limits.																									
6...15	Reserved																										
	0000h...FFFFh	Signal supervision status word.	1 = 1																								
<i>32.05</i>	<i>Supervision 1 function</i>	Selects the mode of signal supervision function 1. Determines how the monitored signal (see parameter <i>32.07</i>) is compared to its lower and upper limits (<i>32.09</i> and <i>32.10</i> respectively). The action to be taken when the condition is fulfilled is selected by <i>32.06</i> .	<i>Disabled</i>																								
	Disabled	Signal supervision 1 not in use.	0																								
	Low	Action is taken whenever the signal is below the Supervision 1 low limit - 0.5 * hysteresis. Action is deactivated whenever the signal is above the Supervision 1 low limit + 0.5 * hysteresis.	1																								
	High	Action is taken whenever the signal is above the Supervision 1 high limit + 0.5 * hysteresis. Action is deactivated whenever the signal is below the Supervision 1 high limit - 0.5 * hysteresis.	2																								
	Abs low	Action is taken whenever the absolute value of the signal is below the absolute value of the Supervision 1 low limit - 0.5 * hysteresis. Action is deactivated whenever the absolute value of the signal is above the absolute value of the Supervision 1 low limit + 0.5 * hysteresis.	3																								

222 Parameters

No.	Name/Value	Description	Default FbEq 16
	Abs high	<p>Action is taken whenever the absolute value of the signal is above the absolute value of the Supervision 1 high limit + 0.5 * hysteresis.</p> <p>Action is deactivated whenever the absolute value of the signal is below the absolute value of the Supervision 1 high limit - 0.5 * hysteresis.</p>	4
	Both	<p>Action is taken whenever the signal is above the Supervision 1 high limit + 0.5 * hysteresis or below the Supervision 1 low limit - 0.5*hysteresis.</p> <p>Action is deactivated whenever the signal is in between the Supervision 1 high limit - 0.5 * hysteresis and the Supervision 1 low limit + 0.5 * hysteresis.</p>	5
	Abs both	<p>Action is taken whenever the absolute value of the signal is above the absolute value of the Supervision 1 high limit + 0.5 * hysteresis or below the absolute value of the Supervision 1 low limit - 0.5 * hysteresis.</p> <p>Action is deactivated whenever the absolute value of the signal is in between the absolute value of the Supervision 1 high limit - 0.5 * hysteresis and the absolute value of the Supervision 1 low limit + 0.5 * hysteresis.</p>	6
	Hysteresis	<p>Action is taken whenever the signal is above the Supervision 1 high limit + 0.5 * hysteresis.</p> <p>Action is deactivated whenever the signal is below the Supervision 1 low limit - 0.5 * hysteresis.</p> <p>The status is unchanged when the signal value is in between the Supervision 1 high limit + 0.5 * hysteresis and the Supervision 1 low limit - 0.5 * hysteresis.</p>	7
	Low falling	<p>Action is taken whenever the signal falls from a value higher than the Supervision 1 low limit + 0.5 * hysteresis to a value which is lower than the Supervision 1 low limit - 0.5 * hysteresis.</p> <p>Action is deactivated when the signal rises to higher than the Supervision 1 low limit + 0.5*hysteresis.</p> <p>Note: Supervision action is also deactivated for every motor start command.</p>	8
	High rising	<p>Action taken whenever the signal rises from a value lower than the Supervision 1 high limit - 0.5 * hysteresis to a value which is higher than the Supervision 1 high limit + 0.5 * hysteresis.</p> <p>Action is deactivated when the signal falls to lower than the Supervision 1 high limit - 0.5 * hysteresis.</p> <p>Note: Supervision action is also deactivated for every motor start command.</p>	9

No.	Name/Value	Description	Default FbEq 16
32.06	<i>Supervision 1 action</i>	Selects whether the drive generates a fault, warning or neither when the value monitored by signal supervision 1 exceeds its limits. Note: This parameter does not affect the status indicated by <i>32.01 Supervision status</i> .	<i>No action</i>
	No action	No warning or fault generated.	0
	Warning	Warning <i>A8B0 Signal supervision</i> is generated.	1
	Fault	The drive trips on fault <i>80B0 Signal supervision</i> .	2
	Fault if running	The drive trips on fault <i>80B0 Signal supervision</i> if running.	3
32.07	<i>Supervision 1 signal</i>	Selects the signal to be monitored by signal supervision function 1.	<i>Frequency</i>
	Zero	None.	0
	Speed	<i>01.01 Motor speed used</i> .	1
	Frequency	<i>01.06 Output frequency</i> .	3
	Current	<i>01.07 Motor current</i> .	4
	Torque	<i>01.10 Motor torque</i> .	6
	DC voltage	<i>01.11 DC voltage</i> .	7
	Output power	<i>01.14 Output power</i> .	8
	AI1	<i>12.11 AI1 actual value</i> .	9
	AI2	<i>12.21 AI2 actual value</i> .	10
	Speed ref ramp in	<i>23.01 Speed ref ramp input</i> .	18
	Speed ref ramp out	<i>23.02 Speed ref ramp output</i> .	19
	Speed ref used	<i>24.01 Used speed reference</i> .	20
	Torque ref used	<i>26.02 Torque reference used</i> .	21
	Freq ref used	<i>28.02 Frequency ref ramp output</i> .	22
	Inverter temperature	<i>05.11 Inverter temperature</i> .	23
	Process PID output	<i>40.01 Process PID output actual</i> .	24
	Process PID feedback	<i>40.02 Process PID feedback actual</i> .	25
	Process PID setpoint	<i>40.03 Process PID setpoint actual</i> .	26
	Process PID deviation	<i>40.04 Process PID deviation actual</i> .	27
	<i>Other</i>	Source selection (see <i>Terms and abbreviations</i>).	-
32.08	<i>Supervision 1 filter time</i>	Defines a filter time constant for the signal monitored by signal supervision 1.	0.000 s
	0.000 ... 30.000 s	Signal filter time.	1000 = 1 s
32.09	<i>Supervision 1 low</i>	Defines the lower limit for signal supervision 1.	0.00
	-21474830.00... 21474830.00	Low limit.	-
32.10	<i>Supervision 1 high</i>	Defines the upper limit for signal supervision 1.	0.00
	-21474830.00... 21474830.00	Upper limit.	-

224 Parameters

No.	Name/Value	Description	Default FbEq 16
32.11	<i>Supervision 1 hysteresis</i>	Defines the hysteresis for the signal monitored by signal supervision 1. Note: This parameter applies to all selections of parameter 32.05, not just Hysteresis.	0.00
	0.00...100000.00	Hysteresis.	-
32.15	<i>Supervision 2 function</i>	Selects the mode of signal supervision function 2. Determines how the monitored signal (see parameter 32.17) is compared to its lower and upper limits (32.19 and 32.20 respectively). The action to be taken when the condition is fulfilled is selected by 32.16.	<i>Disabled</i>
	Disabled	Signal supervision 2 not in use.	0
	Low	Action is taken whenever the signal is below the Supervision 1 low limit - 0.5 * hysteresis. Action is deactivated whenever the signal is above the Supervision 1 low limit + 0.5 * hysteresis.	1
	High	Action is taken whenever the signal is above the Supervision 1 high limit + 0.5 * hysteresis. Action is deactivated whenever the signal is below the Supervision 1 high limit - 0.5 * hysteresis.	2
	Abs low	Action is taken whenever the absolute value of the signal is below the absolute value of the Supervision 1 low limit - 0.5 * hysteresis. Action is deactivated whenever the absolute value of the signal is above the absolute value of the Supervision 1 low limit + 0.5 * hysteresis.	3
	Abs high	Action is taken whenever the absolute value of the signal is above the absolute value of the Supervision 1 high limit + 0.5 * hysteresis. Action is deactivated whenever the absolute value of the signal is below the absolute value of the Supervision 1 high limit - 0.5 * hysteresis.	4
	Both	Action is taken whenever the signal is above the Supervision 1 high limit + 0.5 * hysteresis or below the Supervision 1 low limit - 0.5 * hysteresis. Action is deactivated whenever the signal is in between the Supervision 1 high limit - 0.5 * hysteresis and the Supervision 1 low limit + 0.5 * hysteresis.	5
	Abs both	Action is taken whenever the absolute value of the signal is above the absolute value of the Supervision 1 high limit + 0.5 * hysteresis or below the absolute value of the Supervision 1 low limit - 0.5 * hysteresis. Action is deactivated whenever the absolute value of the signal is in between the absolute value of the Supervision 1 high limit - 0.5 * hysteresis and the absolute value of the Supervision 1 low limit + 0.5 * hysteresis.	6

No.	Name/Value	Description	Default FbEq 16
	Hysteresis	Action is taken whenever the signal is above the Supervision 1 high limit + 0.5 * hysteresis. Action is deactivated whenever the signal is below the Supervision 1 low limit - 0.5 * hysteresis. The status is unchanged when the signal value is in between the Supervision 1 high limit + 0.5 * hysteresis and the Supervision 1 low limit - 0.5 * hysteresis.	7
	Low falling	Action is taken whenever the signal falls from a value higher than the Supervision 1 low limit + 0.5 * hysteresis to a value which is lower than the Supervision 1 low limit - 0.5 * hysteresis. Action is deactivated when the signal rises to higher than the Supervision 1 low limit + 0.5*hysteresis. Note: Supervision action is also deactivated for every motor start command.	8
	High rising	Action taken whenever the signal rises from a value lower than the Supervision 1 high limit - 0.5 * hysteresis to a value which is higher than the Supervision 1 high limit + 0.5 * hysteresis. Action is deactivated when the signal falls to lower than the Supervision 1 high limit - 0.5 * hysteresis. Note: Supervision action is also deactivated for every motor start command.	9
32.16	<i>Supervision 2 action</i>	Selects whether the drive generates a fault, warning or neither when the value monitored by signal supervision 2 exceeds its limits. Note: This parameter does not affect the status indicated by <i>32.01 Supervision status</i> .	<i>No action</i>
	No action	No warning or fault generated.	0
	Warning	Warning <i>A8B0 Signal supervision</i> is generated.	1
	Fault	The drive trips on fault <i>80B0 Signal supervision</i> .	2
	Fault if running	The drive trips on fault <i>80B0 Signal supervision</i> if running.	3
32.17	<i>Supervision 2 signal</i>	Selects the signal to be monitored by signal supervision function 2. For the available selections, see parameter <i>32.07 Supervision 1 signal</i> .	<i>Current</i>
32.18	<i>Supervision 2 filter time</i>	Defines a filter time constant for the signal monitored by signal supervision 2.	0.000 s
	0.000 ... 30.000 s	Signal filter time.	1000 = 1 s
32.19	<i>Supervision 2 low</i>	Defines the lower limit for signal supervision 2.	0.00
	-21474830.00... 21474830.00	Low limit.	-
32.20	<i>Supervision 2 high</i>	Defines the upper limit for signal supervision 2.	0.00
	-21474830.00... 21474830.00	Upper limit.	-

226 Parameters

No.	Name/Value	Description	Default FbEq 16
32.21	<i>Supervision 2 hysteresis</i>	Defines the hysteresis for the signal monitored by signal supervision 2. Note: This parameter applies to all selections of parameter <i>32.15</i> , not just Hysteresis.	0.00
	0.00...100000.00	Hysteresis.	-
32.25	<i>Supervision 3 function</i>	Selects the mode of signal supervision function 3. Determines how the monitored signal (see parameter <i>32.27</i>) is compared to its lower and upper limits (<i>32.29</i> and <i>32.30</i> respectively). The action to be taken when the condition is fulfilled is selected by <i>32.26</i> .	<i>Disabled</i>
	Disabled	Signal supervision 3 not in use.	0
	Low	Action is taken whenever the signal is below the Supervision 1 low limit - 0.5 * hysteresis. Action is deactivated whenever the signal is above the Supervision 1 low limit + 0.5 * hysteresis.	1
	High	Action is taken whenever the signal is above the Supervision 1 high limit + 0.5 * hysteresis. Action is deactivated whenever the signal is below the Supervision 1 high limit - 0.5 * hysteresis.	2
	Abs low	Action is taken whenever the absolute value of the signal is below the absolute value of the Supervision 1 low limit - 0.5 * hysteresis. Action is deactivated whenever the absolute value of the signal is above the absolute value of the Supervision 1 low limit + 0.5 * hysteresis.	3
	Abs high	Action is taken whenever the absolute value of the signal is above the absolute value of the Supervision 1 high limit + 0.5 * hysteresis. Action is deactivated whenever the absolute value of the signal is below the absolute value of the Supervision 1 high limit - 0.5 * hysteresis.	4
	Both	Action is taken whenever the signal is above the Supervision 1 high limit + 0.5 * hysteresis or below the Supervision 1 low limit - 0.5*hysteresis. Action is deactivated whenever the signal is in between the Supervision 1 high limit - 0.5 * hysteresis and the Supervision 1 low limit + 0.5 * hysteresis.	5
	Abs both	Action is taken whenever the absolute value of the signal is above the absolute value of the Supervision 1 high limit + 0.5 * hysteresis or below the absolute value of the Supervision 1 low limit - 0.5 * hysteresis. Action is deactivated whenever the absolute value of the signal is in between the absolute value of the Supervision 1 high limit - 0.5 * hysteresis and the absolute value of the Supervision 1 low limit + 0.5 * hysteresis.	6

No.	Name/Value	Description	Default FbEq 16
	Hysteresis	Action is taken whenever the signal is above the Supervision 1 high limit + 0.5 * hysteresis. Action is deactivated whenever the signal is below the Supervision 1 low limit - 0.5 * hysteresis. The status is unchanged when the signal value is in between the Supervision 1 high limit + 0.5 * hysteresis and the Supervision 1 low limit - 0.5 * hysteresis.	7
	Low falling	Action is taken whenever the signal falls from a value higher than the Supervision 1 low limit + 0.5 * hysteresis to a value which is lower than the Supervision 1 low limit - 0.5 * hysteresis. Action is deactivated when the signal rises to higher than the Supervision 1 low limit + 0.5*hysteresis. Note: Supervision action is also deactivated for every motor start command.	8
	High rising	Action taken whenever the signal rises from a value lower than the Supervision 1 high limit - 0.5 * hysteresis to a value which is higher than the Supervision 1 high limit + 0.5 * hysteresis. Action is deactivated when the signal falls to lower than the Supervision 1 high limit - 0.5 * hysteresis. Note: Supervision action is also deactivated for every motor start command.	9
32.26	Supervision 3 action	Selects whether the drive generates a fault, warning or neither when the value monitored by signal supervision 3 exceeds its limits. Note: This parameter does not affect the status indicated by 32.01 Supervision status.	No action
	No action	No warning or fault generated.	0
	Warning	Warning <i>A8B0 Signal supervision</i> is generated.	1
	Fault	The drive trips on fault <i>80B0 Signal supervision</i> .	2
	Fault if running	The drive trips on fault <i>80B0 Signal supervision</i> if running.	3
32.27	Supervision 3 signal	Selects the signal to be monitored by signal supervision function 3. For the available selections, see parameter 32.07 Supervision 1 signal.	Torque
32.28	Supervision 3 filter time	Defines a filter time constant for the signal monitored by signal supervision 3.	0.000 s
	0.000 ... 30.000 s	Signal filter time.	1000 = 1 s
32.29	Supervision 3 low	Defines the lower limit for signal supervision 3.	0.00
	-21474830.00... 21474830.00	Low limit.	-
32.30	Supervision 3 high	Defines the upper limit for signal supervision 3.	0.00
	-21474830.00... 21474830.00	Upper limit.	-

228 Parameters

No.	Name/Value	Description	Default FbEq 16
32.31	<i>Supervision 3 hysteresis</i>	Defines the hysteresis for the signal monitored by signal supervision 3. Note: This parameter applies to all selections of parameter 32.25, not just Hysteresis.	0.00
	0.00...100000.00	Hysteresis.	-
32.35	<i>Supervision 4 function</i>	Selects the mode of signal supervision function 4. Determines how the monitored signal (see parameter 32.37) is compared to its lower and upper limits (32.39 and 32.30 respectively). The action to be taken when the condition is fulfilled is selected by 32.36.	<i>Disabled</i>
	Disabled	Signal supervision 4 not in use.	0
	Low	Action is taken whenever the signal is below the Supervision 1 low limit - 0.5 * hysteresis. Action is deactivated whenever the signal is above the Supervision 1 low limit + 0.5 * hysteresis.	1
	High	Action is taken whenever the signal is above the Supervision 1 high limit + 0.5 * hysteresis. Action is deactivated whenever the signal is below the Supervision 1 high limit - 0.5 * hysteresis.	2
	Abs low	Action is taken whenever the absolute value of the signal is below the absolute value of the Supervision 1 low limit - 0.5 * hysteresis. Action is deactivated whenever the absolute value of the signal is above the absolute value of the Supervision 1 low limit + 0.5 * hysteresis.	3
	Abs high	Action is taken whenever the absolute value of the signal is above the absolute value of the Supervision 1 high limit + 0.5 * hysteresis. Action is deactivated whenever the absolute value of the signal is below the absolute value of the Supervision 1 high limit - 0.5 * hysteresis.	4
	Both	Action is taken whenever the signal is above the Supervision 1 high limit + 0.5 * hysteresis or below the Supervision 1 low limit - 0.5 * hysteresis. Action is deactivated whenever the signal is in between the Supervision 1 high limit - 0.5 * hysteresis and the Supervision 1 low limit + 0.5 * hysteresis.	5
	Abs both	Action is taken whenever the absolute value of the signal is above the absolute value of the Supervision 1 high limit + 0.5 * hysteresis or below the absolute value of the Supervision 1 low limit - 0.5 * hysteresis. Action is deactivated whenever the absolute value of the signal is in between the absolute value of the Supervision 1 high limit - 0.5 * hysteresis and the absolute value of the Supervision 1 low limit + 0.5 * hysteresis.	6

No.	Name/Value	Description	Default FbEq 16
	Hysteresis	Action is taken whenever the signal is above the Supervision 1 high limit + 0.5 * hysteresis. Action is deactivated whenever the signal is below the Supervision 1 low limit - 0.5 * hysteresis. The status is unchanged when the signal value is in between the Supervision 1 high limit + 0.5 * hysteresis and the Supervision 1 low limit - 0.5 * hysteresis.	7
	Low falling	Action is taken whenever the signal falls from a value higher than the Supervision 1 low limit + 0.5 * hysteresis to a value which is lower than the Supervision 1 low limit - 0.5 * hysteresis. Action is deactivated when the signal rises to higher than the Supervision 1 low limit + 0.5*hysteresis. Note: Supervision action is also deactivated for every motor start command.	8
	High rising	Action taken whenever the signal rises from a value lower than the Supervision 1 high limit - 0.5 * hysteresis to a value which is higher than the Supervision 1 high limit + 0.5 * hysteresis. Action is deactivated when the signal falls to lower than the Supervision 1 high limit - 0.5 * hysteresis. Note: Supervision action is also deactivated for every motor start command.	9
32.36	Supervision 4 action	Selects whether the drive generates a fault, warning or neither when the value monitored by signal supervision 4 exceeds its limits. Note: This parameter does not affect the status indicated by 32.01 Supervision status.	No action
	No action	No warning or fault generated.	0
	Warning	Warning <i>A8B0 Signal supervision</i> is generated.	1
	Fault	The drive trips on fault <i>80B0 Signal supervision</i> .	2
	Fault if running	The drive trips on fault <i>80B0 Signal supervision</i> if running.	3
32.37	Supervision 4 signal	Selects the signal to be monitored by signal supervision function 4. For the available selections, see parameter 32.07 Supervision 1 signal.	Zero
32.38	Supervision 4 filter time	Defines a filter time constant for the signal monitored by signal supervision 4.	0.000 s
	0.000 ... 30.000 s	Signal filter time.	1000 = 1 s
32.39	Supervision 4 low	Defines the lower limit for signal supervision 4.	0.00
	-21474830.00... 21474830.00	Low limit.	-
32.40	Supervision 4 high	Defines the upper limit for signal supervision 4.	0.00
	-21474830.00... 21474830.00	Upper limit.	-

230 Parameters

No.	Name/Value	Description	Default FbEq 16
32.41	<i>Supervision 4 hysteresis</i>	Defines the hysteresis for the signal monitored by signal supervision 4. Note: This parameter applies to all selections of parameter 32.35, not just Hysteresis.	0.00
	0.00...100000.00	Hysteresis.	-
32.45	<i>Supervision 5 function</i>	Selects the mode of signal supervision function 5. Determines how the monitored signal (see parameter 32.47) is compared to its lower and upper limits (32.49 and 32.40 respectively). The action to be taken when the condition is fulfilled is selected by 32.46.	<i>Disabled</i>
	Disabled	Signal supervision 5 not in use.	0
	Low	Action is taken whenever the signal is below the Supervision 1 low limit - 0.5 * hysteresis. Action is deactivated whenever the signal is above the Supervision 1 low limit + 0.5 * hysteresis.	1
	High	Action is taken whenever the signal is above the Supervision 1 high limit + 0.5 * hysteresis. Action is deactivated whenever the signal is below the Supervision 1 high limit - 0.5 * hysteresis.	2
	Abs low	Action is taken whenever the absolute value of the signal is below the absolute value of the Supervision 1 low limit - 0.5 * hysteresis. Action is deactivated whenever the absolute value of the signal is above the absolute value of the Supervision 1 low limit + 0.5 * hysteresis.	3
	Abs high	Action is taken whenever the absolute value of the signal is above the absolute value of the Supervision 1 high limit + 0.5 * hysteresis. Action is deactivated whenever the absolute value of the signal is below the absolute value of the Supervision 1 high limit - 0.5 * hysteresis.	4
	Both	Action is taken whenever the signal is above the Supervision 1 high limit + 0.5 * hysteresis or below the Supervision 1 low limit - 0.5*hysteresis. Action is deactivated whenever the signal is in between the Supervision 1 high limit - 0.5 * hysteresis and the Supervision 1 low limit + 0.5 * hysteresis.	5
	Abs both	Action is taken whenever the absolute value of the signal is above the absolute value of the Supervision 1 high limit + 0.5 * hysteresis or below the absolute value of the Supervision 1 low limit - 0.5 * hysteresis. Action is deactivated whenever the absolute value of the signal is in between the absolute value of the Supervision 1 high limit - 0.5 * hysteresis and the absolute value of the Supervision 1 low limit + 0.5 * hysteresis.	6

No.	Name/Value	Description	Default FbEq 16
	Hysteresis	Action is taken whenever the signal is above the Supervision 1 high limit + 0.5 * hysteresis. Action is deactivated whenever the signal is below the Supervision 1 low limit - 0.5 * hysteresis. The status is unchanged when the signal value is in between the Supervision 1 high limit + 0.5 * hysteresis and the Supervision 1 low limit - 0.5 * hysteresis.	7
	Low falling	Action is taken whenever the signal falls from a value higher than the Supervision 1 low limit + 0.5 * hysteresis to a value which is lower than the Supervision 1 low limit - 0.5 * hysteresis. Action is deactivated when the signal rises to higher than the Supervision 1 low limit + 0.5*hysteresis. Note: Supervision action is also deactivated for every motor start command.	8
	High rising	Action taken whenever the signal rises from a value lower than the Supervision 1 high limit - 0.5 * hysteresis to a value which is higher than the Supervision 1 high limit + 0.5 * hysteresis. Action is deactivated when the signal falls to lower than the Supervision 1 high limit - 0.5 * hysteresis. Note: Supervision action is also deactivated for every motor start command.	9
32.46	<i>Supervision 5 action</i>	Selects whether the drive generates a fault, warning or neither when the value monitored by signal supervision 5 exceeds its limits. Note: This parameter does not affect the status indicated by <i>32.01 Supervision status</i> .	<i>No action</i>
	No action	No warning or fault generated.	0
	Warning	Warning <i>A8B0 Signal supervision</i> is generated.	1
	Fault	The drive trips on fault <i>80B0 Signal supervision</i> .	2
	Fault if running	The drive trips on fault <i>80B0 Signal supervision</i> if running.	3
32.47	<i>Supervision 5 signal</i>	Selects the signal to be monitored by signal supervision function 5. For the available selections, see parameter <i>32.07 Supervision 1 signal</i> .	<i>Zero</i>
32.48	<i>Supervision 5 filter time</i>	Defines a filter time constant for the signal monitored by signal supervision 5.	0.000 s
	0.000 ... 30.000 s	Signal filter time.	1000 = 1 s
32.49	<i>Supervision 5 low</i>	Defines the lower limit for signal supervision 5.	0.00
	-21474830.00... 21474830.00	Low limit.	-
32.50	<i>Supervision 5 high</i>	Defines the upper limit for signal supervision 5.	0.00
	-21474830.00... 21474830.00	Upper limit.	-

232 Parameters

No.	Name/Value	Description	Default FbEq 16
32.51	<i>Supervision 5 hysteresis</i>	Defines the hysteresis for the signal monitored by signal supervision 5. Note: This parameter applies to all selections of parameter 32.45, not just Hysteresis.	0.00
	0.00...100000.00	Hysteresis.	-
32.55	<i>Supervision 6 function</i>	Selects the mode of signal supervision function 6. Determines how the monitored signal (see parameter 32.57) is compared to its lower and upper limits (32.59 and 32.50 respectively). The action to be taken when the condition is fulfilled is selected by 32.56.	<i>Disabled</i>
	Disabled	Signal supervision 6 not in use.	0
	Low	Action is taken whenever the signal is below the Supervision 1 low limit - 0.5 * hysteresis. Action is deactivated whenever the signal is above the Supervision 1 low limit + 0.5 * hysteresis.	1
	High	Action is taken whenever the signal is above the Supervision 1 high limit + 0.5 * hysteresis. Action is deactivated whenever the signal is below the Supervision 1 high limit - 0.5 * hysteresis.	2
	Abs low	Action is taken whenever the absolute value of the signal is below the absolute value of the Supervision 1 low limit - 0.5 * hysteresis. Action is deactivated whenever the absolute value of the signal is above the absolute value of the Supervision 1 low limit + 0.5 * hysteresis.	3
	Abs high	Action is taken whenever the absolute value of the signal is above the absolute value of the Supervision 1 high limit + 0.5 * hysteresis. Action is deactivated whenever the absolute value of the signal is below the absolute value of the Supervision 1 high limit - 0.5 * hysteresis.	4
	Both	Action is taken whenever the signal is above the Supervision 1 high limit + 0.5 * hysteresis or below the Supervision 1 low limit - 0.5*hysteresis. Action is deactivated whenever the signal is in between the Supervision 1 high limit - 0.5 * hysteresis and the Supervision 1 low limit + 0.5 * hysteresis.	5
	Abs both	Action is taken whenever the absolute value of the signal is above the absolute value of the Supervision 1 high limit + 0.5 * hysteresis or below the absolute value of the Supervision 1 low limit - 0.5 * hysteresis. Action is deactivated whenever the absolute value of the signal is in between the absolute value of the Supervision 1 high limit - 0.5 * hysteresis and the absolute value of the Supervision 1 low limit + 0.5 * hysteresis.	6

No.	Name/Value	Description	Default FbEq 16
	Hysteresis	Action is taken whenever the signal is above the Supervision 1 high limit + 0.5 * hysteresis. Action is deactivated whenever the signal is below the Supervision 1 low limit - 0.5 * hysteresis. The status is unchanged when the signal value is in between the Supervision 1 high limit + 0.5 * hysteresis and the Supervision 1 low limit - 0.5 * hysteresis.	7
	Low falling	Action is taken whenever the signal falls from a value higher than the Supervision 1 low limit + 0.5 * hysteresis to a value which is lower than the Supervision 1 low limit - 0.5 * hysteresis. Action is deactivated when the signal rises to higher than the Supervision 1 low limit + 0.5*hysteresis. Note: Supervision action is also deactivated for every motor start command.	8
	High rising	Action taken whenever the signal rises from a value lower than the Supervision 1 high limit - 0.5 * hysteresis to a value which is higher than the Supervision 1 high limit + 0.5 * hysteresis. Action is deactivated when the signal falls to lower than the Supervision 1 high limit - 0.5 * hysteresis. Note: Supervision action is also deactivated for every motor start command.	9
32.56	<i>Supervision 6 action</i>	Selects whether the drive generates a fault, warning or neither when the value monitored by signal supervision 6 exceeds its limits. Note: This parameter does not affect the status indicated by <i>32.01 Supervision status</i> .	<i>No action</i>
	No action	No warning or fault generated.	0
	Warning	Warning <i>A8B0 Signal supervision</i> is generated.	1
	Fault	The drive trips on fault <i>80B0 Signal supervision</i> .	2
	Fault if running	The drive trips on fault <i>80B0 Signal supervision</i> if running.	3
32.57	<i>Supervision 6 signal</i>	Selects the signal to be monitored by signal supervision function 6. For the available selections, see parameter <i>32.07 Supervision 1 signal</i> .	<i>Zero</i>
32.58	<i>Supervision 6 filter time</i>	Defines a filter time constant for the signal monitored by signal supervision 6.	0.000 s
	0.000 ... 30.000 s	Signal filter time.	1000 = 1 s
32.59	<i>Supervision 6 low</i>	Defines the lower limit for signal supervision 6.	0.00
	-21474830.00... 21474830.00	Low limit.	-
32.60	<i>Supervision 6 high</i>	Defines the upper limit for signal supervision 6.	0.00
	-21474830.00... 21474830.00	Upper limit.	-

234 Parameters

No.	Name/Value	Description	Default FbEq 16
32.61	<i>Supervision 6 hysteresis</i>	Defines the hysteresis for the signal monitored by signal supervision 6. Note: This parameter applies to all selections of parameter 32.55, not just Hysteresis.	0.00
	0.00...100000.00	Hysteresis.	-
<i>35 Motor thermal protection</i>		Motor thermal protection settings such as temperature measurement configuration, load curve definition and motor fan control configuration. See also section <i>Motor thermal protection</i> (page 93).	
35.01	<i>Motor estimated temperature</i>	Displays the motor temperature as estimated by the internal motor thermal protection model (see parameters 35.50...35.55). The unit is selected by parameter 96.16 <i>Unit selection</i> . This parameter is read-only.	-
	-60...1000 °C	Estimated motor temperature.	1 = 1°
35.02	<i>Measured temperature 1</i>	Displays the temperature received through the source defined by parameter 35.11 <i>Temperature 1 source</i> . The unit is selected by parameter 96.16 <i>Unit selection</i> . This parameter is read-only.	-
	-60...5000 °C, or -76...9032 °F, or 0...5000 ohm	Measured temperature 1. Note: With a PTC sensor, the unit is ohms. If the measured temperature source selection (35.11) is PTC analog I/O or PTC AI/DI Voltage divider tree, the motor thermal protection function converts the analog input signal (35.14) to PTC resistance value (ohms), and shows it in this parameter. This is the case even the parameter name and unit refer to motor temperature (°C or °F). You cannot change the unit to ohm for the time being (96.16).	1 = 1 unit
35.05	<i>Motor overload level</i>	Shows the motor overload level as a percentage of the motor overload fault limit. See section	0.0
	0.0...300.0%	Motor overload level. 0.0% No motor overloading. 88.0% Motor overloaded to warning level. 100.0% Motor overloaded to fault level.	10 = 1%
35.11	<i>Temperature 1 source</i>	Selects the source from which measured temperature 1 is read. Usually this source is from a sensor connected to the motor controlled by the drive, but it could be used to measure and monitor a temperature from other parts of the process as long as a suitable sensor is used as per the selection list.	<i>Estimated temperature</i>
	Disabled	None. Temperature monitoring function 1 is disabled.	0
	Estimated temperature	Estimated motor temperature (see parameter 35.01 <i>Motor estimated temperature</i>). The temperature is estimated from an internal drive calculation. It is important to set up the ambient temperature of the motor in 35.50 <i>Motor ambient temperature</i> .	1

No.	Name/Value	Description	Default FbEq 16
	KTY84 analog I/O	<p>KTY84 sensor connected to the analog input selected by parameter <i>35.14 Temperature 1 AI source</i> and an analog output.</p> <p>The following settings are required:</p> <ul style="list-style-type: none"> • Set the appropriate analog input unit selection parameter in group <i>12 Standard AI to V (volt)</i>. • In parameter group <i>13 Standard AO</i>, set the source selection parameter of the analog output to <i>Temp sensor 1 excitation</i>. <p>The analog output feeds a constant current through the sensor. As the resistance of the sensor increases along with its temperature, the voltage over the sensor increases. The voltage is read by the analog input and converted into degrees.</p>	2
	1 x Pt100 analog I/O	<p>Pt100 sensor connected to a standard analog input selected by parameter <i>35.14 Temperature 1 AI source</i> and an analog output.</p> <p>The following settings are required:</p> <ul style="list-style-type: none"> • Set the hardware jumper or switch related to the analog input to <i>U (voltage)</i>. Any change must be validated by a control unit reboot. • Set the appropriate analog input unit selection parameter in group <i>12 Standard AI to V (volt)</i>. • In parameter group <i>13 Standard AO</i>, set the source selection parameter of the analog output to <i>Temp sensor 1 excitation</i>. <p>The analog output feeds a constant current through the sensor. As the resistance of the sensor increases along with its temperature, the voltage over the sensor increases. The voltage is read by the analog input and converted into degrees.</p>	5
	2 x Pt100 analog I/O	<p>As selection <i>1 x Pt100 analog I/O</i>, but with two sensors connected in series. Using multiple sensors improves measurement accuracy significantly.</p>	6
	3 x Pt100 analog I/O	<p>As selection <i>1 x Pt100 analog I/O</i>, but with three sensors connected in series. Using multiple sensors improves measurement accuracy significantly.</p>	7
	Direct temperature	<p>The temperature is taken from the source selected by parameter <i>35.14</i>. The value of the source is assumed to be in the unit of temperature specified by parameter 96.16.</p>	11

No.	Name/Value	Description	Default FbEq 16
	KTY83 analog I/O	<p>KTY83 sensor connected to the analog input selected by parameter <i>35.14 Temperature 1 AI source</i> and an analog output.</p> <p>The following settings are required:</p> <ul style="list-style-type: none"> • Set the hardware jumper or switch related to the analog input to U (voltage). Any change must be validated by a control unit reboot. • Set the appropriate analog input unit selection parameter in group <i>12 Standard AI</i> to <i>V</i> (volt). • In parameter group <i>13 Standard AO</i>, set the source selection parameter of the analog output to <i>Temp sensor 1 excitation</i>. <p>The analog output feeds a constant current through the sensor. As the resistance of the sensor increases along with its temperature, the voltage over the sensor increases. The voltage is read by the analog input and converted into degrees.</p>	12
	1 × Pt1000 analog I/O	<p>Pt1000 sensor connected to a standard analog input selected by parameter <i>35.14 Temperature 1 AI source</i> and an analog output.</p> <p>The following settings are required:</p> <ul style="list-style-type: none"> • Set the hardware jumper or switch related to the analog input to U (voltage). Any change must be validated by a control unit reboot. • Set the appropriate analog input unit selection parameter in group <i>12 Standard AI</i> to <i>V</i> (volt). • In parameter group <i>13 Standard AO</i>, set the source selection parameter of the analog output to <i>Temp sensor 1 excitation</i>. <p>The analog output feeds a constant current through the sensor. As the resistance of the sensor increases along with its temperature, the voltage over the sensor increases. The voltage is read by the analog input and converted into degrees.</p>	13
	2 × Pt1000 analog I/O	<p>As selection <i>1 × Pt1000 analog I/O</i>, but with two sensors connected in series. Using multiple sensors improves measurement accuracy significantly.</p>	14
	3 × Pt1000 analog I/O	<p>As selection <i>1 × Pt1000 analog I/O</i>, but with three sensors connected in series. Using multiple sensors improves measurement accuracy significantly.</p>	15
	Ni1000	<p>Ni1000 sensor connected to the analog input selected by parameter <i>35.14 Temperature 1 AI source</i> and an analog output.</p> <p>The following settings are required:</p> <ul style="list-style-type: none"> • Set the hardware jumper or switch related to the analog input to U (voltage). Any change must be validated by a control unit reboot. • Set the appropriate analog input unit selection parameter in group <i>12 Standard AI</i> to <i>V</i> (volt). • In parameter group <i>13 Standard AO</i>, set the source selection parameter of the analog output to <i>Temp sensor 1 excitation</i>. <p>The analog output feeds a constant current through the sensor. As the resistance of the sensor increases along with its temperature, the voltage over the sensor increases. The voltage is read by the analog input and converted into degrees.</p>	16

No.	Name/Value	Description	Default FbEq 16
	PTC analog I/O	PTC sensor connected to analog input selected by parameter <i>35.14 Temperature 1 AI source</i> and an analog output. The required settings are the same as with selection <i>KTY84 analog I/O</i> . Note: With this selection, the control program converts the analog signal to PTC resistance value in ohms and shows it in parameter <i>35.02</i> . The parameter name and unit still refer to temperature.	20
<i>35.12</i>	<i>Temperature 1 fault limit</i>	Defines the fault limit for temperature supervision function 1. The unit is selected by parameter <i>96.16 Unit selection</i> . Note: With a PTC sensor, the unit is ohms.	130 °C, or 266 °F or 4500 ohm
	-60...5000 °C, or -76...9032 °F, or 0...5000 ohm	Fault limit for temperature monitoring function 1.	1 = 1 unit
<i>35.13</i>	<i>Temperature 1 warning limit</i>	Defines the warning limit for temperature supervision function 1. The unit is selected by parameter <i>96.16 Unit selection</i> . Note: With a PTC sensor, the unit is ohms.	110 °C, or 230 °F or 4000 ohm
	-60...5000 °C, or -76...9032 °F, or 0...5000 ohm	Warning limit for temperature monitoring function 1.	1 = 1 unit
<i>35.14</i>	<i>Temperature 1 AI source</i>	Selects the input for parameter <i>35.11 Temperature 1 source selections 1 x Pt100 analog I/O, 2 x Pt100 analog I/O, 3 x Pt100 analog I/O, and Direct temperature</i> .	<i>Not selected</i>
	Not selected	None.	0
	AI1 actual value	Analog input AI1.	1
	AI2 actual value	Analog input AI2.	2
	<i>Other</i>	Source selection (see <i>Terms and abbreviations</i>).	-
<i>35.50</i>	<i>Motor ambient temperature</i>	Defines the ambient temperature of the motor for the motor thermal protection model. The unit is selected by parameter <i>96.16 Unit selection</i> . The motor thermal protection model estimates the motor temperature on the basis of parameters <i>35.50 ... 35.55</i> . The motor temperature increases if it operates in the region above the load curve, and decreases if it operates in the region below the load curve.  WARNING! The model cannot protect the motor if the motor does not cool properly because of dust, dirt, etc.	20 °C or 68 °F
	-60...100 °C or -75 ... 212 °F	Ambient temperature.	1 = 1°

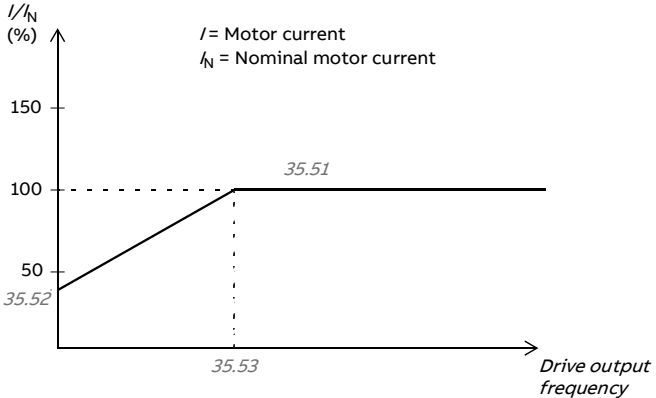
No.	Name/Value	Description	Default FbEq 16
35.51	<i>Motor load curve</i>	<p>Defines the motor load curve together with parameters <i>35.52 Zero speed load</i> and <i>35.53 Break point</i>. The load curve is used by the motor thermal protection model to estimate the motor temperature. When the parameter is set to 100%, the maximum load is taken as the value of parameter <i>99.06 Motor nominal current</i> (higher loads heat up the motor). The load curve level should be adjusted if the ambient temperature differs from the nominal value set in <i>35.50 Motor ambient temperature</i>.</p>  <p>I = Motor current I_N = Nominal motor current</p>	110%
	50...150%	Maximum load for the motor load curve.	1 = 1%
35.52	<i>Zero speed load</i>	<p>Defines the motor load curve together with parameters <i>35.51 Motor load curve</i> and <i>35.53 Break point</i>. Defines the maximum motor load at zero speed of the load curve. A higher value can be used if the motor has an external motor fan to boost the cooling. See the motor manufacturer's recommendations. See parameter <i>35.51 Motor load curve</i>.</p>	70%
	25...150%	Zero speed load for the motor load curve.	1 = 1%
35.53	<i>Break point</i>	<p>Defines the motor load curve together with parameters <i>35.51 Motor load curve</i> and <i>35.52 Zero speed load</i>. Defines the break point frequency of the load curve ie. the point at which the motor load curve begins to decrease from the value of parameter <i>35.51 Motor load curve</i> towards the value of parameter <i>35.52 Zero speed load</i>. See parameter <i>35.51 Motor load curve</i>.</p>	45.00 Hz
	1.00...500.00 Hz	Break point for the motor load curve.	See par. <i>46.02</i>

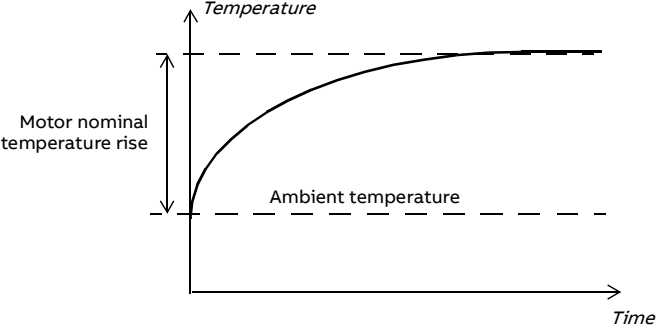
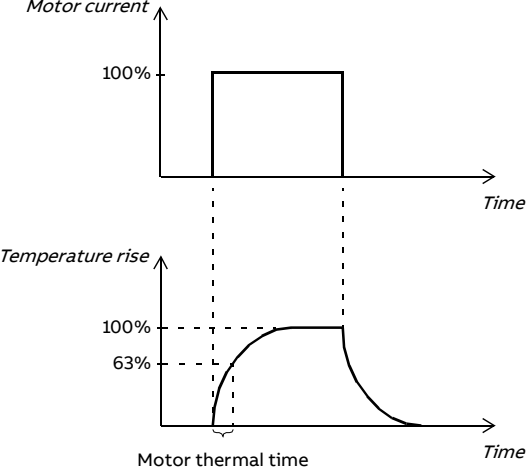
No.	Name/Value	Description	Default FbEq 16
35.54	<i>Motor nominal temperature rise</i>	Defines the temperature rise of the motor above ambient when the motor is loaded with nominal current. See the motor manufacturer's recommendations. The unit is selected by parameter <i>96.16 Unit selection</i> .	80 °C or 176 °F
			
0...300 °C or 32...572 °F		Temperature rise.	1 = 1°
35.55	<i>Motor thermal time constant</i>	Defines the thermal time constant for use with the motor thermal protection model, defined as the time to reach 63% of the nominal motor temperature. See the motor manufacturer's recommendations.	256 s
			
100...10000 s		Motor thermal time constant.	1 = 1 s
35.56	<i>Motor overload action</i>	Defines what action the drive should take when the motor overload specified by parameter <i>35.57</i> occurs.	<i>Warning and fault</i>

240 Parameters

No.	Name/Value	Description	Default FbEq 16
	No action	No action taken.	0
	Warning only	Drive generates warning <i>A783 Motor overload</i> when the motor is overloaded to the warning level, that is, parameter <i>35.05</i> reaches value 88.0%.	1
	Warning and fault	Drive generates warning <i>A783 Motor overload</i> when the motor is overloaded to the warning level, that is, parameter <i>35.05</i> reaches value 88.0%. Drive trips on fault <i>7122 Motor overload</i> when the motor is overloaded to the fault level, that is, parameter <i>35.05</i> reaches value 100.0%.	2
<i>35.57</i>	<i>Motor overload class</i>	Defines the motor overload class to be used. The class of protection is specified by the user as the time for tripping at 6 times the tripping level current. The function shares the following parameters with the Motor thermal model: <ul style="list-style-type: none"> • <i>35.51</i> • <i>35.52</i> • <i>35.53</i> Together, these three parameters set the tripping level as a function of motor frequency.	<i>Class 20</i>
	Class 5	Motor overload class 5.	0
	Class 10	Motor overload class 10.	1
	Class 20	Motor overload class 20.	2
	Class 30	Motor overload class 30.	3
	Class 40	Motor overload class 40.	4
<i>36 Load analyzer</i>		Peak value and amplitude logger settings. See also section <i>Load analyzer</i> (page 100).	
<i>36.01</i>	<i>PVL signal source</i>	Selects the signal to be monitored by the peak value logger. The signal is filtered using the filtering time specified by parameter <i>36.02 PVL filter time</i> . The peak value is stored, along with other pre-selected signals at the time, into parameters <i>36.10 ... 36.15</i> . The peak value logger can be reset using parameter <i>36.09 Reset loggers</i> . The date and time of the last reset are stored into parameters <i>36.16</i> and <i>36.17</i> respectively.	<i>Output power</i>
	Not selected	None (peak value logger disabled).	0
	Motor speed used	<i>01.01 Motor speed used</i> .	1
	Output frequency	<i>01.06 Output frequency</i> .	3
	Motor current	<i>01.07 Motor current</i> .	4
	Motor torque	<i>01.10 Motor torque</i> .	6
	DC voltage	<i>01.11 DC voltage</i> .	7
	Output power	<i>01.14 Output power</i> .	8
	Speed ref ramp in	<i>23.01 Speed ref ramp input</i> .	10

No.	Name/Value	Description	Default FbEq 16
	Speed ref ramp out	23.02 Speed ref ramp output.	11
	Speed ref used	24.01 Used speed reference.	12
	Torque ref used	26.02 Torque reference used.	13
	Freq ref used	28.02 Frequency ref ramp output.	14
	Process PID out	40.01 Process PID output actual.	16
	Other	Source selection (see <i>Terms and abbreviations</i>).	-
36.02	PVL filter time	Peak value logger filtering time. See parameter 36.01 PVL signal source.	2.00 s
	0.00...120.00 s	Peak value logger filtering time.	100 = 1 s
36.06	AL2 signal source	Selects the signal to be monitored by amplitude logger 2. The signal is sampled at 200 ms intervals. The results are displayed by parameters 36.40... 36.49. Each parameter represents an amplitude range, and shows what portion of the samples fall within that range. The signal value corresponding to 100% is defined by parameter 36.07 AL2 signal scaling. Amplitude logger 2 can be reset using parameter 36.09 Reset loggers. The date and time of the last reset are stored into parameters 36.50 and 36.51 respectively. For the selections, see parameter 36.01 PVL signal source.	Motor torque
		See parameter 36.01 for the selections.	
36.07	AL2 signal scaling	Defines the monitored signal value for the amplitude logger AL2 that corresponds to 100% sample value.	100.00
	0.00...32767.00	Signal value corresponding to 100%.	1 = 1
36.09	Reset loggers	Resets the peak value logger and/or amplitude logger 2. (Amplitude logger 1 cannot be reset.)	Done
	Done	Reset completed or not requested (normal operation).	0
	All	Reset both the peak value logger and amplitude logger 2.	1
	PVL	Reset the peak value logger.	2
	AL2	Reset amplitude logger 2.	3
36.10	PVL peak value	Shows the peak value recorded by the peak value logger.	0.00
	-32768.00... 32767.00	Peak value.	1 = 1
36.11	PVL peak date	Shows the date when the peak value was recorded.	01/01/1980
	1/1/1980..6/5/2159	Peak occurrence date.	-
36.12	PVL peak time	Shows the time when the peak value was recorded.	00:00:00
	-	Peak occurrence time.	-
36.13	PVL current at peak	Shows the Motor current at the moment the peak value was recorded.	0.00 A
	-32768.00... 32767.00 A	Motor current at peak.	1 = 1 A

242 Parameters

No.	Name/Value	Description	Default FbEq 16
36.14	<i>PVL DC voltage at peak</i>	Shows the voltage in the intermediate DC circuit of the drive at the moment the peak value was recorded.	0.00 V
	0.00...2000.00 V	DC voltage at peak.	10 = 1 V
36.15	<i>PVL speed at peak</i>	Shows the Motor speed at the moment the peak value was recorded.	0.00 rpm
	-30000... 30000 rpm	Motor speed at peak.	See par. 46.01
36.16	<i>PVL reset date</i>	Shows the date on which the peak value logger was last reset.	01/01/1980
	1/1/1980...6/5/2159	Last reset date of the peak value logger.	-
36.17	<i>PVL reset time</i>	Shows the time when the peak value logger was last reset.	00:00:00
	-	Last reset time of the peak value logger.	-
36.20	<i>AL1 0 to 10%</i>	Shows the percentage of samples recorded by amplitude logger 1 that fall between 0 and 10%. 100% corresponds to the I_{max} value given in the ratings table in chapter Technical data in the hardware manual.	0.00%
	0.00...100.00%	Amplitude logger 1 samples between 0 and 10%.	1 = 1%
36.21	<i>AL1 10 to 20%</i>	Shows the percentage of samples recorded by amplitude logger 1 that fall between 10 and 20%.	0.00%
	0.00...100.00%	Amplitude logger 1 samples between 10 and 20%.	1 = 1%
36.22	<i>AL1 20 to 30%</i>	Shows the percentage of samples recorded by amplitude logger 1 that fall between 20 and 30%.	0.00%
	0.00...100.00%	Amplitude logger 1 samples between 20 and 30%.	1 = 1%
36.23	<i>AL1 30 to 40%</i>	Shows the percentage of samples recorded by amplitude logger 1 that fall between 30 and 40%.	0.00%
	0.00...100.00%	Amplitude logger 1 samples between 30 and 40%.	1 = 1%
36.24	<i>AL2 40 to 50%</i>	Shows the percentage of samples recorded by amplitude logger 1 that fall between 40 and 50%.	0.00%
	0.00...100.00%	Amplitude logger 1 samples between 40 and 50%.	1 = 1%
36.25	<i>AL1 60 to 70%</i>	Percentage of samples recorded by amplitude logger 1 that fall between 50 and 60%.	0.00%
	0.00...100.00%	Amplitude logger 1 samples between 50 and 60%.	1 = 1%
36.26	<i>AL1 60 to 70%</i>	Percentage of samples recorded by amplitude logger 1 that fall between 60 and 70%.	0.00%
	0.00...100.00%	Amplitude logger 1 samples between 60 and 70%.	1 = 1%
36.27	<i>AL1 70 to 80%</i>	Percentage of samples recorded by amplitude logger 1 that fall between 70 and 80%.	0.00%
	0.00...100.00%	Amplitude logger 1 samples between 70 and 80%.	1 = 1%
36.28	<i>AL1 80 to 90%</i>	Percentage of samples recorded by amplitude logger 1 that fall between 80 and 90%.	0.00%
	0.00...100.00%	Amplitude logger 1 samples between 80 and 90%.	1 = 1%
36.29	<i>AL1 over 90%</i>	Percentage of samples recorded by amplitude logger 1 that exceed 90%.	0.00%
	0.00...100.00%	Amplitude logger 1 samples over 90%.	1 = 1%

No.	Name/Value	Description	Default FbEq 16
36.40	<i>AL2 0 to 10%</i>	Percentage of samples recorded by amplitude logger 2 that fall between 0 and 10%.	0.00%
	0.00...100.00%	Amplitude logger 2 samples between 0 and 10%.	1 = 1%
36.41	<i>AL2 10 to 20%</i>	Percentage of samples recorded by amplitude logger 2 that fall between 10 and 20%.	0.00%
	0.00...100.00%	Amplitude logger 2 samples between 10 and 20%.	1 = 1%
36.42	<i>AL2 20 to 30%</i>	Percentage of samples recorded by amplitude logger 2 that fall between 20 and 30%.	0.00%
	0.00...100.00%	Amplitude logger 2 samples between 20 and 30%.	1 = 1%
36.43	<i>AL2 30 to 40%</i>	Percentage of samples recorded by amplitude logger 2 that fall between 30 and 40%.	0.00%
	0.00...100.00%	Amplitude logger 2 samples between 30 and 40%.	1 = 1%
36.44	<i>AL2 40 to 50%</i>	Percentage of samples recorded by amplitude logger 2 that fall between 40 and 50%.	0.00%
	0.00...100.00%	Amplitude logger 2 samples between 40 and 50%.	1 = 1%
36.45	<i>AL2 50 to 60%</i>	Percentage of samples recorded by amplitude logger 2 that fall between 50 and 60%.	0.00%
	0.00...100.00%	Amplitude logger 2 samples between 50 and 60%.	1 = 1%
36.46	<i>AL2 60 to 70%</i>	Percentage of samples recorded by amplitude logger 2 that fall between 60 and 70%.	0.00%
	0.00...100.00%	Amplitude logger 2 samples between 60 and 70%.	1 = 1%
36.47	<i>AL2 70 to 80%</i>	Percentage of samples recorded by amplitude logger 2 that fall between 70 and 80%.	0.00%
	0.00...100.00%	Amplitude logger 2 samples between 70 and 80%.	1 = 1%
36.48	<i>AL2 80 to 90%</i>	Percentage of samples recorded by amplitude logger 2 that fall between 80 and 90%.	0.00%
	0.00...100.00%	Amplitude logger 2 samples between 80 and 90%.	1 = 1%
36.49	<i>AL2 over 90%</i>	Percentage of samples recorded by amplitude logger 2 that exceed 90%.	0.00%
	0.00...100.00%	Amplitude logger 2 samples over 90%.	1 = 1%
36.50	<i>AL2 reset date</i>	The date on which amplitude logger 2 was last reset.	01/01/1980
	1/1/1980..6/5/2159	Last reset date of amplitude logger 2.	-
36.51	<i>AL2 reset time</i>	The time at which amplitude logger 2 was last reset.	00:00:00
	-	Last reset time of amplitude logger 2.	-

No.	Name/Value	Description	Default FbEq 16																		
<i>37 User load curve</i>		Settings for user load curve. See also section <i>User load curve</i> (page 68).																			
37.01	<i>ULC output status word</i>	Displays the status of the monitored signal (37.02). The status is shown only while the drive is running. (The status word is independent of the actions and delays selected by parameters 37.03, 37.04, 37.41 and 37.42.) This parameter is read-only.	0000h																		
<table border="1"> <thead> <tr> <th>Bit</th> <th>Name</th> <th>Description</th> </tr> </thead> <tbody> <tr> <td>0</td> <td>Under load limit</td> <td>1 = Signal lower than the underload curve.</td> </tr> <tr> <td>1</td> <td>Within load range</td> <td>1 = Signal between the underload and overload curve.</td> </tr> <tr> <td>2</td> <td>Overload limit</td> <td>1 = Signal higher than the overload curve.</td> </tr> <tr> <td>3</td> <td>Outside load limit</td> <td>1 = Signal lower than the underload curve or higher than the overload curve.</td> </tr> <tr> <td>4...15</td> <td>Reserved</td> <td></td> </tr> </tbody> </table>				Bit	Name	Description	0	Under load limit	1 = Signal lower than the underload curve.	1	Within load range	1 = Signal between the underload and overload curve.	2	Overload limit	1 = Signal higher than the overload curve.	3	Outside load limit	1 = Signal lower than the underload curve or higher than the overload curve.	4...15	Reserved	
Bit	Name	Description																			
0	Under load limit	1 = Signal lower than the underload curve.																			
1	Within load range	1 = Signal between the underload and overload curve.																			
2	Overload limit	1 = Signal higher than the overload curve.																			
3	Outside load limit	1 = Signal lower than the underload curve or higher than the overload curve.																			
4...15	Reserved																				
0000h...FFFFh		Status of the monitored signal.	1 = 1																		
37.02	<i>ULC supervision signal</i>	Selects the signal to be monitored. The function compares the absolute value of the signal against the load curve.	<i>Motor torque %</i>																		
Not selected		No signal selected. Monitoring disabled.	0																		
Motor speed %		<i>01.03 Motor speed %.</i>	1																		
Motor current %		<i>01.08 Motor current % of motor nom.</i>	2																		
Motor torque %		<i>01.10 Motor torque.</i>	3																		
Output power % of motor nom		<i>01.15 Output power % of motor nom.</i>	4																		
<i>Other</i>		Source selection (see <i>Terms and abbreviations</i>).	-																		
37.03	<i>ULC overload actions</i>	Selects how the drive reacts if the absolute value of the monitored signal stays continuously above the overload curve for longer than the value of 37.41 <i>ULC overload timer</i> .	<i>Disabled</i>																		
Disabled		No warnings or fault generated.	0																		
Warning		The drive generates an <i>A8C1 ULC overload warning</i> if the signal has been continuously over the overload curve for a time defined by parameter 37.41 <i>ULC overload timer</i> .	1																		
Fault		The drive trips on <i>8002 ULC overload fault</i> if the signal has been continuously over the overload curve for a time defined by parameter 37.41 <i>ULC overload timer</i> .	2																		
Warning/Fault		The drive generates an <i>A8C1 ULC overload warning</i> if the signal has been continuously over the overload curve for half of the time defined by parameter 37.41 <i>ULC overload timer</i> . The drive trips on <i>8002 ULC overload fault</i> if the signal has been continuously over the overload curve for a time defined by parameter 37.41 <i>ULC overload timer</i> .	3																		

No.	Name/Value	Description	Default FbEq 16
37.04	<i>ULC underload actions</i>	Selects an action taken if the signal (37.02) stays under the underload curve for a defined time.	<i>Disabled</i>
	Disabled	No warnings or fault generated.	0
	Warning	The drive generates an <i>A8C4 ULC underload warning</i> if the signal has been continuously under the underload curve for a time defined by parameter <i>37.42 ULC underload timer</i> .	1
	Fault	The drive trips on <i>8001 ULC underload fault</i> if the signal has been continuously under the underload curve for a time defined by parameter <i>37.42 ULC underload timer</i> .	2
	Warning/Fault	The drive generates an <i>A8C4 ULC underload warning</i> if the signal has been continuously under the underload curve for half of the time defined by parameter <i>37.42 ULC underload timer</i> . The drive trips on <i>8001 ULC underload fault</i> if the signal has been continuously under the underload curve for a time defined by parameter <i>37.42 ULC underload timer</i> .	3
37.11	<i>ULC speed table point 1</i>	Defines the first of the five speed points on the X-axis of the user load curve. The values of the parameters must satisfy: - 30000.0 rpm \leq <i>37.11 ULC speed table point 1</i> < <i>37.12 ULC speed table point 2</i> < <i>37.13 ULC speed table point 3</i> < <i>37.14 ULC speed table point 4</i> < <i>37.15 ULC speed table point 5</i> \leq 30000.0 rpm. Speed points are used if parameter <i>99.04 Motor control mode</i> is set to <i>Vector</i> or if <i>99.04 Motor control mode</i> is set to <i>Scalar</i> and the reference unit is rpm. The five points must be in order from lowest to highest. The points are defined as positive values, but the range is symmetrically effective also in the negative direction. The monitoring is not active outside these two areas.	150.0 rpm
	-30000.0...30000.0 rpm	Speed.	1 = 1 rpm
37.12	<i>ULC speed table point 2</i>	Defines the second speed point. See parameter <i>37.11 ULC speed table point 1</i> .	750.0 rpm
	-30000.0...30000.0 rpm	Speed.	1 = 1 rpm
37.13	<i>ULC speed table point 3</i>	Defines the third speed point. See parameter <i>37.11 ULC speed table point 1</i> .	1290.0 rpm
	-30000.0...30000.0 rpm	Speed.	1 = 1 rpm
37.14	<i>ULC speed table point 4</i>	Defines the fourth speed point. See parameter <i>37.11 ULC speed table point 1</i> .	1500.0 rpm
	-30000.0...30000.0 rpm	Speed.	1 = 1 rpm

246 Parameters

No.	Name/Value	Description	Default FbEq 16
37.15	<i>ULC speed table point 5</i>	Defines the fifth speed point. See parameter <i>37.11 ULC speed table point 1</i> .	1800.0 rpm
	-30000.0...30000.0 rpm	Speed.	1 = 1 rpm
37.16	<i>ULC frequency table point 1</i>	Defines the first of the five frequency points on the X-axis of the user load curve. The values of the parameters must satisfy: $-500.0 \text{ Hz} \leq 37.16 \text{ ULC frequency table point 1} < 37.17 \text{ ULC frequency table point 2} < 37.18 \text{ ULC frequency table point 3} < 37.19 \text{ ULC frequency table point 4} < 37.20 \text{ ULC frequency table point 5} \leq 500.0 \text{ Hz}$. Frequency points are used if parameter <i>99.04 Motor control mode</i> is set to <i>Scalar</i> and the reference unit is Hz. The five points must be in order from lowest to highest. The points are defined as positive values, but the range is symmetrically effective also in the negative direction. The monitoring is not active outside these two areas.	5.0 Hz
	-500.0...500.0 Hz	Frequency.	1 = 1 Hz
37.17	<i>ULC frequency table point 2</i>	Defines the second frequency point. See parameter <i>37.16 ULC frequency table point 1</i> .	25.0 Hz
	-500.0...500.0 Hz	Frequency.	1 = 1 Hz
37.18	<i>ULC frequency table point 3</i>	Defines the third frequency point. See parameter <i>37.16 ULC frequency table point 1</i> .	43.0 Hz
	-500.0...500.0 Hz	Frequency.	1 = 1 Hz
37.19	<i>ULC frequency table point 4</i>	Defines the fourth frequency point. See parameter <i>37.16 ULC frequency table point 1</i> .	50.0 Hz
	-500.0...500.0 Hz	Frequency.	1 = 1 Hz
37.20	<i>ULC frequency table point 5</i>	Defines the fifth frequency point. See parameter <i>37.16 ULC frequency table point 1</i> .	60.0 Hz
	-500.0...500.0 Hz	Frequency.	1 = 1 Hz
37.21	<i>ULC underload point 1</i>	Defines the first of the five points on the Y-axis that together with the corresponding point on the X-axis (<i>37.11 ULC speed table point 1... 37.15 ULC speed table point 5</i> or <i>37.15 ULC speed table point 5...37.15 ULC frequency table point 5</i>) define the underload (lower) curve. The following conditions must be fulfilled: <ul style="list-style-type: none"> • <i>37.21 ULC underload point 1</i> <= <i>37.31 ULC overload point 1</i> • <i>37.22 ULC underload point 2</i> <= <i>37.32 ULC overload point 2</i> • <i>37.23 ULC underload point 3</i> <= <i>37.33 ULC overload point 3</i> • <i>37.24 ULC underload point 4</i> <= <i>37.34 ULC overload point 4</i> • <i>37.25 ULC underload point 5</i> <= <i>37.35 ULC overload point 5</i> 	10.0%
	-1600.0...1600.0%	Underload point.	1 = 1%

No.	Name/Value	Description	Default FbEq 16
37.22	<i>ULC underload point 2</i>	Defines the second underload point. See parameter <i>37.21 ULC underload point 1</i> .	15.0%
	-1600.0...1600.0%	Underload point.	1 = 1%
37.23	<i>ULC underload point 3</i>	Defines the third underload point. See parameter <i>37.21 ULC underload point 1</i> .	25.0%
	-1600.0...1600.0%	Underload point.	1 = 1%
37.24	<i>ULC underload point 4</i>	Defines the fourth underload point. See parameter <i>37.21 ULC underload point 1</i> .	30.0%
	-1600.0...1600.0%	Underload point.	1 = 1%
37.25	<i>ULC underload point 5</i>	Defines the fifth underload point. See parameter <i>37.21 ULC underload point 1</i> .	30.0%
	-1600.0...1600.0%	Underload point.	1 = 1%
37.31	<i>ULC overload point 1</i>	Defines the first of the five points on the Y-axis that together with the corresponding point on the X-axis (<i>37.11 ULC speed table point 1...37.15 ULC frequency table point 5</i> or <i>37.15 ULC frequency table point 5...37.20 ULC frequency table point 5</i>) define the overload (higher) curve. At each of the five points the value of the underload curve point must be equal to or smaller than the value of the overload curve point. See parameter <i>37.21 ULC underload point 1</i> .	300.0%
	-1600.0...1600.0%	Overload point.	1 = 1%
37.32	<i>ULC overload point 2</i>	Defines the second overload point. See parameter <i>37.31 ULC overload point 1</i> .	300.0%
	-1600.0...1600.0%	Overload point.	1 = 1%
37.33	<i>ULC overload point 3</i>	Defines the third overload point. See parameter <i>37.31 ULC overload point 1</i> .	300.0%
	-1600.0...1600.0%	Overload point.	1 = 1%
37.34	<i>ULC overload point 4</i>	Defines the fourth overload point. See parameter <i>37.31 ULC overload point 1</i> .	300.0%
	-1600.0...1600.0%	Overload point.	1 = 1%
37.35	<i>ULC overload point 5</i>	Defines the fifth overload point. See parameter <i>37.31 ULC overload point 1</i> .	300.0%
	-1600.0...1600.0%	Overload point.	1 = 1%
37.41	<i>ULC overload timer</i>	Defines the time for which the monitored signal must continuously stay above the overload curve before the drive takes the action selected by <i>37.03 ULC overload actions</i> .	20.0 s
	0.0...10000.0 s	Time.	1 = 1 s
37.42	<i>ULC underload timer</i>	Defines the time for which the monitored signal must continuously stay below the underload curve before the drive takes the action selected by <i>37.04 ULC underload actions</i> .	20.0 s
	0.0...10000.0 s	Time.	1 = 1 s

248 Parameters

No.	Name/Value	Description	Default FbEq 16
<i>40 Process PID set 1</i>		Parameter values for process PID control. The drive output can be controlled by the process PID. When the process PID control is enabled, the drive controls the process feedback to the reference value. Two different parameter sets can be defined for the process PID. One parameter set is in use at a time. The first set is made up of parameters <i>40.07...40.50</i> , the second set is defined by the parameters in group <i>41 Process PID set 2</i> . The binary source that defines which set is used is selected by parameter <i>40.57 PID set1/set2 selection</i> . See also the PID control chain diagrams in chapter <i>Control chain diagrams</i> .	
<i>40.01</i>	<i>Process PID output actual</i>	Displays the output of the process PID controller. See the control chain diagram on page <i>417</i> . This parameter is read-only.	0.00
	-200000.00... 200000.00%	Process PID controller output.	1 = 1%
<i>40.02</i>	<i>Process PID feedback actual</i>	Displays the value of process feedback after source selection, mathematical function (parameter <i>40.10 Set 1 feedback function</i>), and filtering. See the control chain diagram on page <i>417</i> . This parameter is read-only.	0.00
	-200000.00... 200000.00 PID customer units	Process feedback.	1 = 1 PID customer unit
<i>40.03</i>	<i>Process PID setpoint actual</i>	Displays the value of process PID setpoint after source selection, mathematical function (<i>40.18 Set 1 setpoint function</i>), limitation and ramping. See the control chain diagram on page <i>417</i> . This parameter is read-only.	0.00
	-200000.00... 200000.00 PID customer units	Setpoint for process PID controller.	1 = 1 PID customer unit
<i>40.04</i>	<i>Process PID deviation actual</i>	Displays the process PID deviation. By default, this value equals setpoint - feedback, but deviation can be inverted by parameter <i>40.31 Set 1 deviation inversion</i> . See the control chain diagram on page <i>405</i> . This parameter is read-only.	0.00
	-200000.00... 200000.00 PID customer units	PID deviation.	1 = 1 PID customer unit
<i>40.05</i>	<i>Process PID trim output act</i>	Displays the process PID trimmed reference output. See control chain diagram on page <i>405</i> . This parameter is read-only.	-
	32768.0...32767.0	Process PID trimmed reference.	1 = 1

No.	Name/Value	Description	Default FbEq 16																																													
40.06	<i>Process PID status word</i>	Displays status information on process PID control. This parameter is read-only.	0000h																																													
		<table border="1"> <thead> <tr> <th>Bit</th> <th>Name</th> <th>Value</th> </tr> </thead> <tbody> <tr> <td>0</td> <td>PID active</td> <td>1 = Process PID control active.</td> </tr> <tr> <td>1</td> <td>Setpoint frozen</td> <td>1 = Process PID setpoint frozen.</td> </tr> <tr> <td>2</td> <td>Output frozen</td> <td>1 = Process PID controller output frozen.</td> </tr> <tr> <td>3</td> <td>PID sleep mode</td> <td>1 = Sleep mode active.</td> </tr> <tr> <td>4</td> <td>Sleep boost</td> <td>1 = Sleep boost active.</td> </tr> <tr> <td>5</td> <td>Trim mode</td> <td>1 = Trim function active.</td> </tr> <tr> <td>6</td> <td>Tracking mode</td> <td>1 = Tracking function active.</td> </tr> <tr> <td>7</td> <td>Output limit high</td> <td>1 = PID output is being limited by parameter 40.37.</td> </tr> <tr> <td>8</td> <td>Output limit low</td> <td>1 = PID output is being limited by parameters 40.36</td> </tr> <tr> <td>9</td> <td>Deadband active</td> <td>1 = Deadband active (see parameter 40.39)</td> </tr> <tr> <td>10</td> <td>PID set</td> <td>0 = Parameter set 1 in use. 1 = Parameter set 2 in use.</td> </tr> <tr> <td>11</td> <td>Reserved</td> <td></td> </tr> <tr> <td>12</td> <td>Internal setpoint active</td> <td>1 = Internal setpoint active (see parameters 40.16...40.23)</td> </tr> <tr> <td>13...15</td> <td>Reserved</td> <td></td> </tr> </tbody> </table>	Bit	Name	Value	0	PID active	1 = Process PID control active.	1	Setpoint frozen	1 = Process PID setpoint frozen.	2	Output frozen	1 = Process PID controller output frozen.	3	PID sleep mode	1 = Sleep mode active.	4	Sleep boost	1 = Sleep boost active.	5	Trim mode	1 = Trim function active.	6	Tracking mode	1 = Tracking function active.	7	Output limit high	1 = PID output is being limited by parameter 40.37.	8	Output limit low	1 = PID output is being limited by parameters 40.36	9	Deadband active	1 = Deadband active (see parameter 40.39)	10	PID set	0 = Parameter set 1 in use. 1 = Parameter set 2 in use.	11	Reserved		12	Internal setpoint active	1 = Internal setpoint active (see parameters 40.16...40.23)	13...15	Reserved		
Bit	Name	Value																																														
0	PID active	1 = Process PID control active.																																														
1	Setpoint frozen	1 = Process PID setpoint frozen.																																														
2	Output frozen	1 = Process PID controller output frozen.																																														
3	PID sleep mode	1 = Sleep mode active.																																														
4	Sleep boost	1 = Sleep boost active.																																														
5	Trim mode	1 = Trim function active.																																														
6	Tracking mode	1 = Tracking function active.																																														
7	Output limit high	1 = PID output is being limited by parameter 40.37.																																														
8	Output limit low	1 = PID output is being limited by parameters 40.36																																														
9	Deadband active	1 = Deadband active (see parameter 40.39)																																														
10	PID set	0 = Parameter set 1 in use. 1 = Parameter set 2 in use.																																														
11	Reserved																																															
12	Internal setpoint active	1 = Internal setpoint active (see parameters 40.16...40.23)																																														
13...15	Reserved																																															
	0000h...FFFFh	Process PID control status word.	1 = 1																																													
40.07	<i>Process PID operation mode</i>	Activates/deactivates process PID control. Note: Process PID control is only available in external control; see section <i>Local and external control locations</i> (page 46).	Off																																													
	Off	Process PID control inactive.	0																																													
	On	Process PID control active.	1																																													
	On when drive running	Process PID control is active when the drive is running.	2																																													
40.08	<i>Set 1 feedback 1 source</i>	Selects the primary source of process feedback. See the control chain diagram on page 416.	Not selected																																													
	Not selected	None.	0																																													
	AI1 scaled	12.12 AI1 scaled value	1																																													
	AI2 scaled	12.22 AI2 scaled value	2																																													
	Freq in scaled	11.39 Freq in 1 scaled value	3																																													
	AI1 percent	12.101 AI1 percent value	8																																													
	AI2 percent	12.102 AI2 percent value	9																																													
	Feedback storage	40.91 Feedback data storage	10																																													
	Other	Source selection (see <i>Terms and abbreviations</i>).	-																																													
40.09	<i>Set 1 feedback 2 source</i>	Selects the second source of process feedback. The second source is used only if the setpoint function requires two inputs. For the selections, see parameter 40.08 Set 1 feedback 1 source.	Not selected																																													

250 Parameters

No.	Name/Value	Description	Default FbEq 16						
40.10	Set 1 feedback function	Defines how process feedback is calculated from the two feedback sources selected by parameters 40.08 Set 1 feedback 1 source and 40.09 Set 1 feedback 2 source.	In1						
	In1	Source 1.	0						
	In1+In2	Sum of sources 1 and 2.	1						
	In1-In2	Source 2 subtracted from source 1.	2						
	In1*In2	Source 1 multiplied by source 2.	3						
	In1/In2	Source 1 divided by source 2.	4						
	MIN(In1,In2)	Smaller of the two sources.	5						
	MAX(In1,In2)	Greater of the two sources.	6						
	AVE(In1,In2)	Average of the two sources.	7						
	sqrt(In1)	Square root of source 1.	8						
	sqrt(In1-In2)	Square root of (source 1 - source 2).	9						
	sqrt(In1+In2)	Square root of (source 1 + source 2).	10						
	sqrt(In1)+sqrt(In2)	Square root of source 1 + square root of source 2.	11						
40.11	Set 1 feedback filter time	Defines the filter time constant for process feedback.	0.000 s						
	0.000...30.000 s	Feedback filter time.	1 = 1 s						
40.14	Set 1 setpoint scaling	<p>Defines, together with parameter 40.15 Set 1 output scaling, a general scaling factor for the process PID control chain.</p> <p>The scaling can be utilized when, for example, the process setpoint is input in Hz, and the output of the PID controller is used as an rpm value in speed control. In this case, this parameter might be set to 50, and parameter 40.15 to the nominal motor speed at 50 Hz.</p> <p>In effect, the output of the PID controller = [40.15] when deviation (setpoint - feedback) = [40.14] and [40.32] = 1.</p> <p>Note: The scaling is based on the ratio between 40.14 and 40.15. For example, the values 50 and 1500 would produce the same scaling as 1 and 30.</p>	0.00						
	32768.00...32767.00	Process setpoint base.	1 = 1						
40.15	Set 1 output scaling	See parameter 40.14 Set 1 setpoint scaling.	1500.00; 1800.00 (95.20 b0)						
		<table border="1"> <thead> <tr> <th>Operation mode (see par. 19.01)</th> <th>Scaling</th> </tr> </thead> <tbody> <tr> <td>Speed control</td> <td>46.01 Speed scaling</td> </tr> <tr> <td>Frequency control</td> <td>46.02 Frequency scaling</td> </tr> </tbody> </table>	Operation mode (see par. 19.01)	Scaling	Speed control	46.01 Speed scaling	Frequency control	46.02 Frequency scaling	
Operation mode (see par. 19.01)	Scaling								
Speed control	46.01 Speed scaling								
Frequency control	46.02 Frequency scaling								
	32768.00...32767.00	Process PID controller output base.	1 = 1						
40.16	Set 1 setpoint 1 source	Selects the primary source of process PID setpoint. See the control chain diagram on page 417.	Not selected						
	Not selected	None.	0						
	Internal setpoint	Internal setpoint. See parameter 40.19 Set 1 internal setpoint sel1.	2						

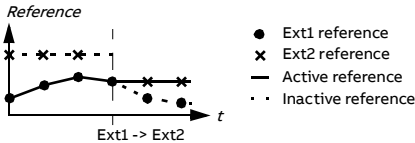
No.	Name/Value	Description	Default FbEq 16
	AI1 scaled	12.12 AI1 scaled value	3
	AI2 scaled	12.22 AI2 scaled value	4
	Motor potentiometer	22.80 Motor potentiometer ref act (output of the motor potentiometer).	8
	Freq in scaled	11.39 Freq in 1 scaled value	10
	AI1 percent	12.101 AI1 percent value	11
	AI2 percent	12.102 AI2 percent value	12
	Control panel (ref saved)	Panel reference (03.01 Panel reference, see page 114) saved by the control system for the location where the control returns is used as the reference. Reference 	13
	Control panel (ref copied)	Panel reference (03.01 Panel reference, see page 114) for the previous control location is used as the reference when the control location changes if the references for the two locations are of the same type (eg frequency/speed/torque/PID); otherwise, the actual signal is used as the new reference. Reference 	14
	EFB ref1	03.09 EFB reference 1	19
	EFB ref2	03.10 EFB reference 2	20
	Setpoint data storage	40.92 Setpoint data storage	24
	Integrated panel (ref saved)	See above Control panel (ref saved).	26
	Integrated panel (ref copied)	See above Control panel (ref copied).	27
	Other	Source selection (see Terms and abbreviations).	-
40.17	Set 1 setpoint 2 source	Selects the second source of process setpoint. The second source is used only if the setpoint function requires two inputs. For the selections, see parameter 40.16 Set 1 setpoint 1 source.	Not selected
40.18	Set 1 setpoint function	Selects a function between the setpoint sources selected by parameters 40.16 Set 1 setpoint 1 source and 40.17 Set 1 setpoint 2 source.	In1
	In1	Source 1.	0
	In1+In2	Sum of sources 1 and 2.	1
	In1-In2	Source 2 subtracted from source 1.	2

252 Parameters

No.	Name/Value	Description	Default FbEq 16															
	In1*In2	Source 1 multiplied by source 2.	3															
	In1/In2	Source 1 divided by source 2.	4															
	MIN(In1,In2)	Smaller of the two sources.	5															
	MAX(In1,In2)	Greater of the two sources.	6															
	AVE(In1,In2)	Average of the two sources.	7															
	sqrt(In1)	Square root of source 1.	8															
	sqrt(In1-In2)	Square root of (source 1 - source 2).	9															
	sqrt(In1+In2)	Square root of (source 1 + source 2).	10															
	sqrt(In1)+sqrt(In2)	Square root of source 1 + square root of source 2.	11															
40.19	Set 1 internal setpoint sel1	<p>Selects together with 40.20 Set 1 internal setpoint sel2 the internal setpoint out of the presets defined by parameters 40.21...40.23.</p> <p>Note: Parameters 40.16 Set 1 setpoint 1 source and 40.17 Set 1 setpoint 2 source must be set to Internal setpoint</p>	Not selected															
		<table border="1"> <thead> <tr> <th>Source defined by par. 40.19</th> <th>Source defined by par. 40.20</th> <th>Internal setpoint active</th> </tr> </thead> <tbody> <tr> <td>0</td> <td>0</td> <td>Setpoint source</td> </tr> <tr> <td>1</td> <td>0</td> <td>1 (par. 40.21)</td> </tr> <tr> <td>0</td> <td>1</td> <td>2 (par. 40.22)</td> </tr> <tr> <td>1</td> <td>1</td> <td>3 (par. 40.23)</td> </tr> </tbody> </table>	Source defined by par. 40.19	Source defined by par. 40.20	Internal setpoint active	0	0	Setpoint source	1	0	1 (par. 40.21)	0	1	2 (par. 40.22)	1	1	3 (par. 40.23)	
Source defined by par. 40.19	Source defined by par. 40.20	Internal setpoint active																
0	0	Setpoint source																
1	0	1 (par. 40.21)																
0	1	2 (par. 40.22)																
1	1	3 (par. 40.23)																
	Not selected	0.	0															
	Selected	1.	1															
	DI1	Digital input DI1 (10.02 DI delayed status, bit 0).	2															
	DI2	Digital input DI2 (10.02 DI delayed status, bit 1).	3															
	DI3	Digital input DI3 (10.02 DI delayed status, bit 2).	4															
	DI4	Digital input DI4 (10.02 DI delayed status, bit 3).	5															
	DI5	Digital input DI5 (10.02 DI delayed status, bit 4).	6															
	Supervision 1	Bit 0 of 32.01 Supervision status.	21															
	Supervision 2	Bit 1 of 32.01 Supervision status.	22															
	Supervision 3	Bit 2 of 32.01 Supervision status.	23															
	Other [bit]	Source selection (see Terms and abbreviations).	-															
40.20	Set 1 internal setpoint sel2	<p>Selects together with 40.19 Set 1 internal setpoint sel1 the internal setpoint used out of the three internal setpoints defined by parameters 40.21...40.23. See table at 40.19 Set 1 internal setpoint sel1.</p>	Not selected															
	Not selected	0.	0															
	Selected	1.	1															
	DI1	Digital input DI1 (10.02 DI delayed status, bit 0).	2															
	DI2	Digital input DI2 (10.02 DI delayed status, bit 1).	3															
	DI3	Digital input DI3 (10.02 DI delayed status, bit 2).	4															

No.	Name/Value	Description	Default FbEq 16
	DI4	Digital input DI4 (<i>10.02 DI delayed status</i> , bit 3).	5
	DI5	Digital input DI5 (<i>10.02 DI delayed status</i> , bit 4).	6
	Supervision 1	Bit 0 of <i>32.01 Supervision status</i>	21
	Supervision 2	Bit 1 of <i>32.01 Supervision status</i>	22
	Supervision 3	Bit 2 of <i>32.01 Supervision status</i>	23
	<i>Other [bit]</i>	Source selection (see <i>Terms and abbreviations</i>).	-
40.21	<i>Set 1 internal setpoint 1</i>	Internal process setpoint 1. See parameter 40.19 <i>Set 1 internal setpoint sel1</i> .	0.00 PID customer units
	-200000.00... 200000.00 PID customer units	Internal process setpoint 1.	1 = 1 PID customer unit
40.22	<i>Set 1 internal setpoint 2</i>	Internal process setpoint 2. See parameter 40.19 <i>Set 1 internal setpoint sel1</i> .	0.00 PID customer units
	-200000.00... 200000.00 PID customer units	Internal process setpoint 2.	1 = 1 PID customer unit
40.23	<i>Set 1 internal setpoint 3</i>	Internal process setpoint 3. See parameter 40.19 <i>Set 1 internal setpoint sel1</i> .	0.00 PID customer units
	-200000.00... 200000.00 PID customer units	Internal process setpoint 3.	1 = 1 PID customer unit
40.24	<i>Set 1 internal setpoint 0</i>	Internal process setpoint 0. See parameter 40.19 <i>Set 1 internal setpoint sel1</i> .	0.00 PID customer units
	-200000.00... 200000.00 PID customer units	Internal process setpoint 0.	1 = 1 PID customer unit
40.26	<i>Set 1 setpoint min</i>	Defines a minimum limit for the process PID controller setpoint.	0.00
	-200000.00... 200000.00	Minimum limit for process PID controller setpoint.	1 = 1
40.27	<i>Set 1 setpoint max</i>	Defines a maximum limit for the process PID controller setpoint.	200000.00
	-200000.00... 200000.00	Maximum limit for process PID controller setpoint.	1 = 1
40.28	<i>Set 1 setpoint increase time</i>	Defines the minimum time it takes for the setpoint to increase from 0% to 100%.	0.0 s
	0.0...1800.0 s	Setpoint increase time.	1 = 1
40.29	<i>Set 1 setpoint decrease time</i>	Defines the minimum time it takes for the setpoint to decrease from 100% to 0%.	0.0 s
	0.0...1800.0 s	Setpoint decrease time.	1 = 1

254 Parameters

No.	Name/Value	Description	Default FbEq 16
40.30	Set 1 setpoint freeze enable	Freezes, or defines a source that can be used to freeze, the setpoint of the process PID controller. This feature is useful when the reference is based on a process feedback connected to an analog input, and the sensor must be serviced without stopping the process. 1 = Process PID controller setpoint frozen See also parameter 40.38 Set 1 output freeze enable	Not selected
	Not selected	Process PID controller setpoint not frozen.	0
	Selected	Process PID controller setpoint frozen.	1
	DI1	Digital input DI1 (10.02 DI delayed status, bit 0).	2
	DI2	Digital input DI2 (10.02 DI delayed status, bit 1).	3
	DI3	Digital input DI3 (10.02 DI delayed status, bit 2).	4
	DI4	Digital input DI4 (10.02 DI delayed status, bit 3).	5
	DI5	Digital input DI5 (10.02 DI delayed status, bit 4).	6
	Supervision 1	Bit 0 of 32.01 Supervision status	21
	Supervision 2	Bit 1 of 32.01 Supervision status	22
	Supervision 3	Bit 2 of 32.01 Supervision status.	23
	Other [bit]	Source selection (see Terms and abbreviations).	-
40.31	Set 1 deviation inversion	Inverts the input of the process PID controller. 0 = Deviation not inverted (Deviation = Setpoint - Feedback) 1 = Deviation inverted (Deviation = Feedback - Setpoint) See also section Sleep and boost functions for process PID control (page 75).	Not inverted (Ref - Fbk)
	Not inverted (Ref - Fbk)	0.	0
	Inverted (Fbk - Ref)	1.	1
	Other [bit]	Source selection (see Terms and abbreviations).	-
40.32	Set 1 gain	Defines the gain for the process PID controller. See parameter 40.33 Set 1 integration time.	1.00
	0.01...100.00	Gain for PID controller.	100 = 1

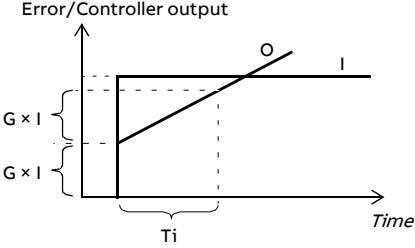
No.	Name/Value	Description	Default FbEq 16
40.33	<i>Set 1 integration time</i>	<p>Defines the integration time for the process PID controller. This time needs to be set to the same order of magnitude as the reaction time of the process being controlled, otherwise instability will result.</p>  <p>I = controller input (error) O = controller output G = gain Ti = integration time</p> <p>Note: Setting this value to 0 disables the “I” part, turning the PID controller into a PD controller.</p>	60.0 s
	0.0...9999.0 s	Integration time.	1 = 1 s
40.34	<i>Set 1 derivation time</i>	<p>Defines the derivation time of the process PID controller. The derivative component at the controller output is calculated on basis of two consecutive error values (E_{K-1} and E_K) according to the following formula: PID DERIV TIME $\times (E_K - E_{K-1}) / T_S$, in which $T_S = 2$ ms sample time $E = \text{Error} = \text{Process reference} - \text{process feedback}$.</p>	0.000 s
	0.000...10.000 s	Derivation time.	1000 = 1 s

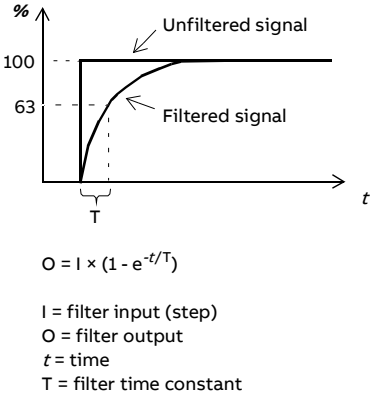
No.	Name/Value	Description	Default FbEq 16
40.35	<i>Set 1 derivation filter time</i>	<p>Defines the time constant of the 1-pole filter used to smooth the derivative component of the process PID controller.</p>  <p>$O = I \times (1 - e^{-t/T})$</p> <p>I = filter input (step) O = filter output t = time T = filter time constant</p>	0.0 s
	0.0...10.0 s	Filter time constant.	10 = 1 s
40.36	<i>Set 1 output min</i>	Defines the minimum limit for the process PID controller output. Using the minimum and maximum limits, it is possible to restrict the operation range.	0.00
	-200000.00... 200000.00	Minimum limit for process PID controller output.	1 = 1
40.37	<i>Set 1 output max</i>	Defines the maximum limit for the process PID controller output. See parameter 40.36 <i>Set 1 output min</i> .	100.00
	-200000.00... 200000.00	Maximum limit for process PID controller output.	1 = 1
40.38	<i>Set 1 output freeze enable</i>	<p>Freezes (or defines a source that can be used to freeze) the output of the process PID controller, keeping the output at the value it was before freeze was enabled. This feature can be used when, for example, a sensor providing process feedback must to be serviced without stopping the process.</p> <p>1 = Process PID controller output frozen</p> <p>See also parameter 40.30 <i>Set 1 setpoint freeze enable</i>.</p>	<i>Not selected</i>
	Not selected	Process PID controller output not frozen.	0
	Selected	Process PID controller output frozen.	1
	DI1	Digital input DI1 (10.02 <i>DI delayed status</i> , bit 0).	2
	DI2	Digital input DI2 (10.02 <i>DI delayed status</i> , bit 1).	3
	DI3	Digital input DI3 (10.02 <i>DI delayed status</i> , bit 2).	4
	DI4	Digital input DI4 (10.02 <i>DI delayed status</i> , bit 3).	5
	DI5	Digital input DI5 (10.02 <i>DI delayed status</i> , bit 4).	6
	Supervision 1	Bit 0 of 32.01 <i>Supervision status</i>	21

No.	Name/Value	Description	Default FbEq 16
	Supervision 2	Bit 1 of <i>32.01 Supervision status</i>	22
	Supervision 3	Bit 2 of <i>32.01 Supervision status</i> .	23
	<i>Other [bit]</i>	Source selection (see <i>Terms and abbreviations</i>).	-
40.39	<i>Set 1 deadband range</i>	Defines a deadband around the setpoint. Whenever process feedback enters the deadband, a delay timer starts. If the feedback remains within the deadband longer than the delay (<i>40.40 Set 1 deadband delay</i>), the PID controller output is frozen. Normal operation resumes after the feedback value leaves the deadband.	0.0
	0.....200000.0	Deadband range.	1 = 1
40.40	<i>Set 1 deadband delay</i>	Delay for the deadband. See parameter <i>40.39 Set 1 deadband range</i> .	0.0 s
	0.0 ... 3600.0 s	Delay for deadband area.	1 = 1 s
40.43	<i>Set 1 sleep level</i>	Defines the start limit for the sleep function. If the value is 0.0, set 1 sleep mode is disabled. The sleep function compares the motor speed to the value of this parameter. If the motor speed remains below this value longer than the sleep delay defined by <i>40.44 Set 1 sleep delay</i> , the drive enters the sleep mode and stops the motor.	0.0
	0.0...200000.0	Sleep start level.	1 = 1
40.44	<i>Set 1 sleep delay</i>	Defines a delay before the sleep function actually becomes enabled, to prevent nuisance sleeping. The delay timer starts when the sleep mode is enabled by parameter <i>40.43 Set 1 sleep level</i> , and resets when the sleep mode is disabled.	60.0 s
	0.0...3600.0 s	Sleep start delay.	1 = 1 s
40.45	<i>Set 1 sleep boost time</i>	Defines a boost time for the sleep boost step. See parameter <i>40.46 Set 1 sleep boost step</i> .	0.0 s
	0.0...3600.0 s	Sleep boost time.	1 = 1 s

258 Parameters

No.	Name/Value	Description	Default FbEq 16
40.46	<i>Set 1 sleep boost step</i>	When the drive is entering sleep mode, the process setpoint is increased by this value for the time defined by parameter <i>40.45 Set 1 sleep boost time</i> . If active, sleep boost is aborted when the drive wakes up.	0.0 PID customer units
	0.0...200000.0 PID customer units	Sleep boost step.	1 = 1 PID customer unit
40.47	<i>Set 1 wake-up deviation</i>	Defines the wake-up level as deviation between process setpoint and feedback. When the deviation exceeds the value of this parameter, and remains there for the duration of the wake-up delay (<i>40.48 Set 1 wake-up delay</i>), the drive wakes up. See also parameter <i>40.31 Set 1 deviation inversion</i> .	0.00 PID customer units
	- 200000.00...200000.0 PID customer units	Wake-up level (as deviation between process setpoint and feedback).	1 = 1 PID customer unit
40.48	<i>Set 1 wake-up delay</i>	Defines a wake-up delay for the sleep function to prevent nuisance wake-ups. See parameter <i>40.47 Set 1 wake-up deviation</i> . The delay timer starts when the deviation exceeds the wake-up level (<i>40.47 Set 1 wake-up deviation</i>), and resets if the deviation falls below the wake-up level.	0.50 s
	0.00...60.00 s	Wake-up delay.	1 = 1 s
40.49	<i>Set 1 tracking mode</i>	Activates (or selects a source that activates) tracking mode. In tracking mode, the value selected by parameter <i>40.50 Set 1 tracking ref selection</i> is substituted for the PID controller output. See also section <i>Tracking</i> (page 77). 1 = Tracking mode enabled	<i>Not selected</i>
	Not selected	0.	0
	Selected	1.	1
	DI1	Digital input DI1 (<i>10.02 DI delayed status</i> , bit 0).	2
	DI2	Digital input DI2 (<i>10.02 DI delayed status</i> , bit 1).	3
	DI3	Digital input DI3 (<i>10.02 DI delayed status</i> , bit 2).	4
	DI4	Digital input DI4 (<i>10.02 DI delayed status</i> , bit 3).	5
	DI5	Digital input DI5 (<i>10.02 DI delayed status</i> , bit 4).	6
	Supervision 1	Bit 0 of <i>32.01 Supervision status</i> .	21
	Supervision 2	Bit 1 of <i>32.01 Supervision status</i> .	22
	Supervision 3	Bit 2 of <i>32.01 Supervision status</i> .	23
	Supervision 4	Bit 3 of <i>32.01 Supervision status</i>	24
	Supervision 5	Bit 4 of <i>32.01 Supervision status</i>	25
	Supervision 6	Bit 5 of <i>32.01 Supervision status</i>	26
	<i>Other [bit]</i>	Source selection (see <i>Terms and abbreviations</i>).	-
40.50	<i>Set 1 tracking ref selection</i>	Selects the value source for tracking mode. See parameter <i>40.49 Set 1 tracking mode</i> .	<i>Not selected</i>
	Not selected	None.	0

No.	Name/Value	Description	Default FbEq 16
	AI1 scaled	12.12 AI1 scaled value	1
	AI2 scaled	12.22 AI2 scaled value.	2
	Other	Source selection (see <i>Terms and abbreviations</i>).	-
40.51	Set 1 trim mode	Activates the trim function and selects between direct and proportional trimming (or a combination of both). With trimming, it is possible to apply a corrective factor to the drive reference (setpoint). The output after trimming is available as parameter 40.05 Process PID trim output act. See the control chain diagram on page 405.	Off
	Off	The trim function is inactive.	0
	Direct	The trim function is active. The trimming factor is relative to the maximum speed, torque or frequency; the selection between these is made by parameter 40.52 Set 1 trim selection.	1
	Proportional	The trim function is active. The trimming factor is relative to the reference selected by parameter 40.53 Set 1 trimmed ref pointer.	2
	Combined	The trim function is active. The trimming factor is a combination of both <i>Direct</i> and <i>Proportional</i> modes; the proportions of each are defined by parameter 40.53 Set 1 trim mix.	3
40.52	Set 1 trim selection	Selects whether trimming is used for correcting the speed, torque or frequency reference.	Speed
	Torque	Torque reference trimming.	1
	Speed	Speed reference trimming.	2
	Frequency	Frequency reference trimming.	3
40.53	Set 1 trimmed ref pointer	Selects the signal source for the trim reference.	Not selected
	Not selected	None.	0
	AI1 scaled	12.12 AI1 scaled value (see page 137).	1
	AI2 scaled	12.22 AI2 scaled value (see page 139).	2
	Other	Source selection (see <i>Terms and abbreviations</i> on page 108).	-
40.54	Set 1 trim mix	When parameter 40.51 Set 1 trim mode is set to <i>Combined</i> , defines the effect of direct and proportional trim sources in the final trimming factor. 0.000 = 100% proportional 0.500 = 50% proportional, 50% direct 1.000 = 100% direct	0.000
	0.000 ... 1.000	Trim mix.	1 = 1
40.55	Set 1 trim adjust	Defines a multiplier for the trimming factor. This value is multiplied by the result of parameter 40.51 Set 1 trim mode. Consequently, the result of the multiplication is used to multiply the result of parameter 40.56 Set 1 trim source.	1.000
	-100.000 ... 100.000	Multiplier for trimming factor.	1 = 1
40.56	Set 1 trim source	Selects the reference to be trimmed.	PID output
	PID ref	PID setpoint.	1

260 Parameters

No.	Name/Value	Description	Default FbEq 16
	PID output	PID controller output.	2
40.57	<i>PID set1/set2 selection</i>	Selects the source that determines whether process PID parameter set 1 (parameters 40.07...40.50) or set 2 (group 41 Process PID set 2) is used. 0 = PID set 1 in use 1 = PID set 2 in use	<i>PID set 1</i>
	PID set 1	PID set 1.	0
	PID set 2	PID set 2.	1
	DI1	Digital input DI1 (10.02 DI delayed status, bit 0).	2
	DI2	Digital input DI2 (10.02 DI delayed status, bit 1).	3
	DI3	Digital input DI3 (10.02 DI delayed status, bit 2).	4
	DI4	Digital input DI4 (10.02 DI delayed status, bit 3).	5
	DI5	Digital input DI5 (10.02 DI delayed status, bit 4).	6
	Supervision 1	Bit 0 of 32.01 Supervision status	21
	Supervision 2	Bit 1 of 32.01 Supervision status	22
	Supervision 3	Bit 2 of 32.01 Supervision status.	23
	<i>Other [bit]</i>	Source selection (see <i>Terms and abbreviations</i>).	-
40.58	<i>Set 1 increase prevention</i>	Activates increase prevention of PID integration term for PID set 1	<i>No</i>
	No	Increase prevention not in use.	0
	Limiting	The process PID integration term is not increased. This parameter is valid for the PID set 1.	1
	<i>Other [bit]</i>	Source selection (see <i>Terms and abbreviations</i> on page 108).	-
40.59	<i>Set 1 decrease prevention</i>	Activates decrease prevention of PID integration term for PID set 1.	<i>No</i>
	No	Decrease prevention not in use.	0
	Limiting	The process PID integration term is not decreased. This parameter is valid for the PID set 1.	1
	<i>Other [bit]</i>	Source selection (see <i>Terms and abbreviations</i> on page 108).	-
40.60	<i>Set 1 PID activation source</i>	Selects the source of process PID set 1 activation.	<i>On</i>
	Off	Set 1 PID activation source is Off.	0
	On	Set 1 PID activation source is On.	1
	Follow Ext1/Ext2 selection	Selection follows the value of parameter 19.11 Ext1/Ext2 selection. By changing to Ext2 control location, Process PID set 1 is activated.	2
	DI1	Digital input DI1 (10.02 DI delayed status, bit 0).	3
	DI2	Digital input DI2 (10.02 DI delayed status, bit 1).	4
	DI3	Digital input DI3 (10.02 DI delayed status, bit 2).	5
	DI4	Digital input DI4 (10.02 DI delayed status, bit 3).	6
	DI5	Digital input DI5 (10.02 DI delayed status, bit 4).	7

No.	Name/Value	Description	Default FbEq 16
	<i>Other [bit]</i>	Source selection (see <i>Terms and abbreviations</i> on page 108).	-
40.61	<i>Setpoint scaling actual</i>	Actual setpoint scaling. See parameter 40.14 <i>Set 1 setpoint scaling</i> .	0.00
	-200000.00... 200000.00 PID customer units	Scaling.	1 = 1 PID customer unit
40.62	<i>PID internal setpoint actual</i>	Displays the value of the internal setpoint. See the control chain diagram on page 416. This parameter is read-only.	0.00 PID unit 1
	-200000.00... 200000.00 PID customer units	Process PID internal setpoint.	1 = 1 PID customer unit
40.65	<i>Trim auto connection</i>	Enables the PID trim auto connection and connects PID trim 40.05 <i>Process PID trim output act</i> to either speed, torque or frequency chains, based on the trim selection parameter 40.52 <i>Set 1 trim selection</i> . See control chain diagram on page 416.	<i>Disable</i>
	Disable	Disable PID trim auto connection.	0
	Enable	Enable PID trim auto connection.	1
40.79	<i>Set 1 units</i>	Selects the units used for Process PID setpoint, feedback and deviation.	150
	User text	User editable text. User text default is "PID unit 1".	0
	%	Percentage.	4
	bar	Bar.	74
	kPa	Kilopascal.	75
	Pa	Pascal,	77
	psi	Pound per square inch.	76
	CFM	Cubic feet per minute.	26
	inH ₂ O	Inch of water.	58
	°C	Centigrade.	150
	°F	Fahrenheit.	151
	mbar	Millibar.	44
	m ³ /h	Cubic meters per hour.	78
	dm ³ /h	Cubic decimeters per hour.	21
	l/s	Liters per second.	79
	l/min	Liters per minute.	37
	l/h	Liters per hour.	38
	m ³ /s	Cubic meter per second.	88
	m ³ /min	Cubic meter per minute.	40
	km ³ /h	Cubic kilometers per hour.	131
	gal/s	Gallons per second.	47
	ft ³ /s	Cubic feet per second.	50
	ft ³ /min	Cubic feet per minute.	51

262 Parameters

No.	Name/Value	Description	Default FbEq 16
	ft ³ /h	Cubic feet per hour.	52
	ppm	Parts per million.	34
	inHg	Inch of mercury.	29
	kCFM	Thousands of cubic feet per hour.	126
	inWC	Inch water column.	65
	gpm	Gallons per minute.	80
	gal/min	Gallons per minute.	48
	in wg	Inch of water.	59
	MPa	Megapascal.	94
	ftWC	Foot water column.	125
40.80	<i>Set 1 PID output min source</i>	Selects the source for set 1 PID output minimum.	<i>Set1 output min</i>
	None	None.	0
	Set1 output min	40.36 <i>Set 1 output min.</i>	1
	<i>Other</i>	Source selection (see <i>Terms and abbreviations</i> on page 108).	-
40.81	<i>Set 1 PID output max source</i>	Selects the source for set 1 PID output maximum.	<i>Set1 output max</i>
	None	None.	0
	Set1 output max	40.37 <i>Set 1 output max</i>	1
	<i>Other</i>	Source selection (see <i>Terms and abbreviations</i> on page 108).	-
40.89	<i>Set 1 setpoint multiplier</i>	Defines the multiplier with which the result of the function specified by parameter 40.18 <i>Set 1 setpoint function</i> is multiplied.	1.00
	-200000.00... 200000.00	Multiplier.	1 = 1
40.90	<i>Set 1 feedback multiplier</i>	Defines the multiplier with which the result of the function specified by parameter 40.10 <i>Set 1 feedback function</i> is multiplied.	1.00
	-200000.00... 200000.00	Multiplier.	1 = 1
40.91	<i>Feedback data storage</i>	Storage parameter for receiving a process feedback value eg. through the embedded fieldbus interface. The value can be sent to the drive as Modbus I/O data. Set the target selection parameter of that particular data (58.101...58.114) to <i>Feedback data storage</i> . In 40.08 <i>Set 1 feedback 1 source</i> (or 40.09 <i>Set 1 feedback 2 source</i>), select <i>Feedback storage</i> .	0.00
	-327.68 ... 327.67	Storage parameter for process feedback.	100 = 1

No.	Name/Value	Description	Default FbEq 16
40.92	<i>Setpoint data storage</i>	Storage parameter for receiving a process setpoint value eg. through the embedded fieldbus interface. The value can be sent to the drive as Modbus I/O data. Set the target selection parameter of that particular data (58.101...58.114) to <i>Setpoint data storage</i> . In 40.16 <i>Set 1 setpoint 1 source</i> (or 40.17 <i>Set 1 setpoint 2 source</i>), select <i>Setpoint data storage</i> .	0.00
	-327.68 ... 327.67	Storage parameter for process setpoint.	100 = 1
40.96	<i>Process PID output %</i>	Percentage scaled signal of parameter 40.01 <i>Process PID feedback actual</i> .	0.00%
	-100.00...100.00%	Percentage.	100 = 1%
40.97	<i>Process PID feedback %</i>	Percentage scaled signal of parameter 40.02 <i>Process PID feedback actual</i> .	0.00%
	-100.00...100.00%	Percentage.	100 = 1%
40.98	<i>Process PID setpoint %</i>	Percentage scaled signal of parameter 40.03 <i>Process PID setpoint actual</i> .	0.00%
	-100.00...100.00%	Percentage.	100 = 1%
40.99	<i>Process PID deviation %</i>	Percentage scaled signal of parameter 40.04 <i>Process PID deviation actual</i> .	0.00%
	-100.00...100.00%	Percentage.	100 = 1%
41 <i>Process PID set 2</i>		A second set of parameter values for process PID control. The selection between this set and first set (parameter group 40 <i>Process PID set 1</i>) is made by parameter 40.57 <i>PID set1/set2 selection</i> . See also parameters 40.01...40.06, and the control chain diagrams on pages 416 and 417.	
41.08	<i>Set 2 feedback 1 source</i>	See parameter 40.08 <i>Set 1 feedback 1 source</i> .	<i>Not selected</i>
41.09	<i>Set 2 feedback 2 source</i>	See parameter 40.09 <i>Set 1 feedback 2 source</i> .	<i>Not selected</i>
41.10	<i>Set 2 feedback function</i>	See parameter 40.10 <i>Set 1 feedback function</i> .	<i>In1</i>
41.11	<i>Set 2 feedback filter time</i>	See parameter 40.11 <i>Set 1 feedback filter time</i> .	0.000 s
41.14	<i>Set 2 setpoint scaling</i>	See parameter 40.14 <i>Set 1 setpoint scaling</i> .	0.00
41.15	<i>Set 2 output scaling</i>	See parameter 40.15 <i>Set 1 output scaling</i> .	1500.00; 1800.00 (95.20 b0)
41.16	<i>Set 2 setpoint 1 source</i>	See parameter 40.16 <i>Set 1 setpoint 1 source</i> .	<i>Not selected</i>
41.17	<i>Set 2 setpoint 2 source</i>	See parameter 40.17 <i>Set 1 setpoint 2 source</i> .	<i>Not selected</i>
41.18	<i>Set 2 setpoint function</i>	See parameter 40.18 <i>Set 1 setpoint function</i> .	<i>In1</i>
41.19	<i>Set 2 internal setpoint sel1</i>	See parameter 40.19 <i>Set 1 internal setpoint sel1</i> .	<i>Not selected</i>

264 Parameters

No.	Name/Value	Description	Default FbEq 16
41.20	Set 2 internal setpoint sel2	See parameter 40.20 Set 1 internal setpoint sel2.	Not selected
41.21	Set 2 internal setpoint 1	See parameter 40.21 Set 1 internal setpoint 1.	0.00 PID customer units
41.22	Set 2 internal setpoint 2	See parameter 40.22 Set 1 internal setpoint 2.	0.00 PID customer units
41.23	Set 2 internal setpoint 3	See parameter 40.23 Set 1 internal setpoint 3.	0.00 PID customer units
41.24	Set 2 internal setpoint 0	40.24 Set 1 internal setpoint 0.	0.00 PID customer units
41.26	Set 2 setpoint min	See parameter 40.26 Set 1 setpoint min.	0.00
41.27	Set 2 setpoint max	See parameter 40.27 Set 1 setpoint max.	200000.00
41.28	Set 2 setpoint increase time	See parameter 40.28 Set 1 setpoint increase time.	0.0 s
41.29	Set 2 setpoint decrease time	See parameter 40.29 Set 1 setpoint decrease time.	0.0 s
41.30	Set 2 setpoint freeze enable	See parameter 40.30 Set 1 setpoint freeze enable.	Not selected
41.31	Set 2 deviation inversion	See parameter 40.31 Set 1 deviation inversion.	Not inverted (Ref - Fbk)
41.32	Set 2 gain	See parameter 40.32 Set 1 gain.	1.00
41.33	Set 2 integration time	See parameter 40.33 Set 1 integration time.	60.0 s
41.34	Set 2 derivation time	See parameter 40.34 Set 1 derivation time.	0.000 s
41.35	Set 2 derivation filter time	See parameter 40.35 Set 1 derivation filter time.	0.0 s
41.36	Set 2 output min	See parameter 40.36 Set 1 output min.	0.00
41.37	Set 2 output max	See parameter 40.37 Set 1 output max.	100.00
41.38	Set 2 output freeze enable	See parameter 40.38 Set 1 output freeze enable.	Not selected
41.39	Set 2 deadband range	See parameter 40.39 Set 1 deadband range.	0.0
41.40	Set 2 deadband delay	See parameter 40.40 Set 1 deadband delay.	0.0 s
41.43	Set 2 sleep level	See parameter 40.43 Set 1 sleep level.	0.0
41.44	Set 2 sleep delay	See parameter 40.44 Set 1 sleep delay.	60.0 s
41.45	Set 2 sleep boost time	See parameter 40.45 Set 1 sleep boost time.	0.0 s
41.46	Set 2 sleep boost step	See parameter 40.46 Set 1 sleep boost step.	0.0 PID customer units
41.47	Set 2 wake-up deviation	See parameter 40.47 Set 1 wake-up deviation.	0.00 PID customer units
41.48	Set 2 wake-up delay	See parameter 40.48 Set 1 wake-up delay.	0.50 s

No.	Name/Value	Description	Default FbEq 16
41.49	Set 2 tracking mode	See parameter 40.49 Set 1 tracking mode.	Not selected
41.50	Set 2 tracking ref selection	See parameter 40.50 Set 1 tracking ref selection.	Not selected
41.51	Set 2 trim mode	See parameter 40.51 Set 1 trim mode.	Off
41.52	Set 2 trim selection	See parameter 40.52 Set 1 trim selection.	Speed
41.53	Set 2 trimmed ref pointer	See parameter 40.53 Set 1 trimmed ref pointer.	Not selected
41.54	Set 2 trim mix	See parameter 40.54 Set 1 trim mix.	0.000
41.55	Set 2 trim adjust	See parameter 40.55 Set 1 trim adjust.	1.000
41.56	Set 2 trim source	See parameter 40.56 Set 1 trim source.	PID output
41.56	Set 2 increase prevention	See parameter 40.58 Set 1 increase prevention.	No
41.59	Set 2 decrease prevention	See parameter 40.59 Set 1 decrease prevention.	No
41.60	Set 2 PID activation source	See parameter 40.60 Set 1 PID activation source.	On
41.79	Set 2 units	See parameter 40.79 Set 1 units.	150
41.80	Set 2 PID output min source	Selects the source for set 2 PID output minimum.	Set2 output min
	None	None.	0
	Set2 output min	41.36 Set 2 output min.	1
41.81	Set 2 PID output max source	Selects the source for set 2 PID output maximum.	Set2 output max
	None	None.	0
	Set2 output max	40.47 Set 2 output max	1
41.89	Set 2 setpoint multiplier	See parameter 40.89 Set 1 setpoint multiplier.	1.00
41.90	Set 2 feedback multiplier	Defines the multiplier k used in formulas of parameter 41.10 Set 2 feedback function. See parameter 40.90 Set 1 feedback multiplier.	1.00
43 Brake chopper		Settings for the internal brake chopper.	
43.01	Braking resistor temperature	Displays the estimated temperature of the brake resistor, or how close the brake resistor is to being too hot. The value is given in percent where 100% is the eventual temperature the resistor would reach when loaded long enough with its rated maximum load capacity (43.09 Brake resistor Pmax cont). The temperature calculation is based on the values of parameters 43.08, 43.09 and 43.10, and on the assumption that the resistor is installed as instructed by the manufacturer (ie, it cools down as expected).	-
	0.0...120.0%	Estimated brake resistor temperature.	1 = 1%

No.	Name/Value	Description	Default FbEq 16
43.06	<i>Brake chopper enable</i>	Enables brake chopper control and selects the brake resistor overload protection method (calculation or measurement). Note: Before enabling brake chopper control, ensure that <ul style="list-style-type: none"> a brake resistor is connected overvoltage control is switched off (parameter 30.30 <i>Overvoltage control</i>) the supply voltage range (parameter 95.01 <i>Supply voltage</i>) has been selected correctly. 	<i>Disabled</i>
	Disabled	Brake chopper control disabled.	0
	Enabled with thermal model	Brake chopper control enabled with the brake resistor protection based on the thermal model. If you select this, you must also specify the values needed by the model, ie. parameters 43.08, and 43.09, 43.10, 43.11 and 43.12. See the resistor manufacturer data sheet.	1
	Enabled without thermal model	Brake chopper control enabled without resistor overload protection based on the thermal model if the resistor is equipped with a thermal switch that is wired to open the main contactor of the drive if the resistor overheats. For more information, see chapter <i>Resistor braking</i> in the hardware manual.	2
	Overvoltage peak protection	Brake chopper control enabled in an overvoltage condition. This setting is intended for situations where <ul style="list-style-type: none"> the braking chopper is not needed for runtime operation, ie. to dissipate the inertial energy of the motor, the motor is able to store a considerable amount magnetic energy in its windings, and the motor might, deliberately or inadvertently, be stopped by coasting. In such a situation, the motor would potentially discharge enough magnetic energy towards the drive to cause damage. To protect the drive, the brake chopper can be used with a small resistor dimensioned merely to handle the magnetic energy (not the inertial energy) of the motor. With this setting, the brake chopper is activated only whenever the DC voltage exceeds the overvoltage limit. During normal use, the brake chopper is not operating.	3
43.07	<i>Brake chopper runtime enable</i>	Selects the source for quick brake chopper on/off control. 0 = Brake chopper IGBT pulses are cut off 1 = Normal brake chopper IGBT modulation allowed. This parameter can be used to enable the chopper operation only when the supply is missing from a drive with a regenerative supply unit.	<i>On</i>
	Off	0	0
	On	1	1
	<i>Other [bit]</i>	Source selection (see <i>Terms and abbreviations</i>).	-

No.	Name/Value	Description	Default FbEq 16
43.08	<i>Brake resistor thermal tc</i>	Defines the thermal time constant of the brake resistor thermal model.	0 s
	0...10000 s	Brake resistor thermal time constant, ie, the rated time to achieve 63% temperature.	1 = 1 s
43.09	<i>Brake resistor Pmax cont</i>	Defines the maximum continuous load of the brake resistor which will eventually raise the resistor temperature to the maximum allowed value (= continuous heat dissipation capacity of the resistor in kW) but not above it. The value is used in the resistor overload protection based on the thermal model. See parameter <i>43.06 Brake chopper enable</i> . See the data sheet of the brake resistor used.	0.00 kW
	0.00... 10000.00 kW	Maximum continuous load of the brake resistor.	1 = 1 kW
43.10	<i>Brake resistance</i>	Defines the resistance value of the brake resistor. The value is used for the brake resistor protection based on the thermal model. See parameter <i>43.06 Brake chopper enable</i> .	0.0 ohm
	0.0...1000.0 ohm	Brake resistor resistance value.	1 = 1 ohm
43.11	<i>Brake resistor fault limit</i>	Selects the fault limit for the brake resistor protection based on the thermal model. See parameter <i>43.06 Brake chopper enable</i> . When the limit is exceeded, the drive trips on fault <i>7183 BR excess temperature</i> . The value is given in percent of the temperature the resistor reaches when loaded with the power defined by parameter <i>43.09 Brake resistor Pmax cont</i> .	105%
	0...150%	Brake resistor temperature fault limit.	1 = 1%
43.12	<i>Brake resistor warning limit</i>	Selects the warning limit for the brake resistor protection based on the thermal model. See parameter <i>43.06 Brake chopper enable</i> . When the limit is exceeded, the drive generates a <i>A793 BR excess temperature</i> warning. The value is given in percent of the temperature the resistor reaches when loaded with the power defined by parameter <i>43.09 Brake resistor Pmax cont</i> .	95%
	0...150%	Brake resistor temperature warning limit.	1 = 1%

No.	Name/Value	Description	Default FbEq 16
<i>44 Mechanical brake control</i>		Configuration of mechanical brake control.	
44.01	<i>Brake control status</i>	Displays the mechanical brake control status word. This parameter is read-only.	0000h
Bit	Name	Information	
0	Open command	Close/open command to brake actuator (0 = close, 1 = open). Connect this bit to desired output.	
1	Opening torque request	1 = Opening torque requested from drive logic	
2	Hold stopped request	1 = Hold requested from drive logic	
3	Ramp to stopped	1 = Ramping down to zero speed requested from drive logic	
4	Enabled	1 = Brake control is enabled	
5	Closed	1 = Brake control logic in <i>BRAKE CLOSED</i> state	
6	Opening	1 = Brake control logic in <i>BRAKE OPENING</i> state	
7	Open	1 = Brake control logic in <i>BRAKE OPEN</i> state	
8	Closing	1 = Brake control logic in <i>BRAKE CLOSING</i> state	
9...15	Reserved		
0000h...FFFFh		Mechanical brake control status word.	1 = 1
44.06	<i>Brake control enable</i>	Activates/deactivates (or selects a source that activates/deactivates) the mechanical brake control logic. 0 = Brake control inactive 1 = Brake control active	<i>Not selected</i>
Not selected		The brake control function is disabled.	0
Selected		The brake control function is enabled.	1
DI1		Digital input DI1 (<i>10.02 DI delayed status</i> , bit 0).	2
DI2		Digital input DI2 (<i>10.02 DI delayed status</i> , bit 1).	3
DI3		Digital input DI3 (<i>10.02 DI delayed status</i> , bit 2).	4
DI4		Digital input DI4 (<i>10.02 DI delayed status</i> , bit 3).	5
DI5		Digital input DI5 (<i>10.02 DI delayed status</i> , bit 4).	6
Supervision 1		Bit 0 of <i>32.01 Supervision status</i>	24
Supervision 2		Bit 1 of <i>32.01 Supervision status</i>	25
Supervision 3		Bit 2 of <i>32.01 Supervision status</i> .	26
Supervision 4		Bit 3 of <i>32.01 Supervision status</i> .	27
Supervision 5		Bit 4 of <i>32.01 Supervision status</i> .	28
Supervision 6		Bit 5 of <i>32.01 Supervision status.x</i>	29
<i>Other [bit]</i>		Source selection (see <i>Terms and abbreviations</i>).	-

No.	Name/Value	Description	Default FbEq 16
44.08	<i>Brake open delay</i>	Defines the brake open delay, ie. the delay between the internal open brake command and the release of motor speed control. The delay timer starts when the drive has magnetized the motor. Simultaneously with the timer start, the brake control logic energizes the brake control output and the brake starts to open. Set this parameter to the value of mechanical opening delay specified by the brake manufacturer.	0.00 s
	0.00...5.00 s	Brake open delay.	100 = 1 s
44.13	<i>Brake close delay</i>	Specifies a delay between a close command (that is, when the brake control output is de-energized) and when the drive stops modulating. This is to keep the motor live and under control until the brake actually closes. Set this parameter equal to the value specified by the brake manufacturer as the mechanical make-up time of the brake.	0.00 s
	0.00...60.00 s	Brake close delay.	100 = 1 s
44.14	<i>Brake close level</i>	Defines the brake close speed as an absolute value. After motor speed has decelerated to this level, a close command is given.	10.00 rpm
	0.00...1000.00 rpm	Brake close speed.	See par. 46.01
<i>45 Energy efficiency</i>		Settings for the energy saving calculators. See also section <i>Energy saving calculators</i> (page 99).	
45.01	<i>Saved GW hours</i>	Energy saved in GWh compared to direct-on-line motor connection. This parameter is incremented when <i>45.02 Saved MW hours</i> rolls over. This parameter is read-only (see parameter <i>45.21 Energy calculations reset</i>).	-
	0...65535 GWh	Energy savings in GWh.	1 = 1 GWh
45.02	<i>Saved MW hours</i>	Energy saved in MWh compared to direct-on-line motor connection. This parameter is incremented when <i>45.03 Saved kW hours</i> rolls over. When this parameter rolls over, parameter <i>45.01 Saved GW hours</i> is incremented. This parameter is read-only (see parameter <i>45.21 Energy calculations reset</i>).	-
	0...999 MWh	Energy savings in MWh.	1 = 1 MWh
45.03	<i>Saved kW hours</i>	Energy saved in kWh compared to direct-on-line motor connection. If the internal brake chopper of the drive is enabled, all energy fed by the motor to the drive is assumed to be converted into heat, but the calculation still records savings made by controlling the speed. If the chopper is disabled, then regenerated energy from the motor is also recorded here. When this parameter rolls over, parameter <i>45.02 Saved MW hours</i> is incremented. This parameter is read-only (see parameter <i>45.21 Energy calculations reset</i>).	-
	0.0...999.9 kWh	Energy savings in kWh.	10 = 1 kWh

270 Parameters

No.	Name/Value	Description	Default FbEq 16
45.04	<i>Saved energy</i>	Energy saved in kWh compared to direct-on-line motor connection. This parameter is read-only (see parameter 45.21 <i>Energy calculations reset</i>).	-
	0.0...214748364.7 kWh	Energy savings in kWh.	1 = 1 kWh
45.05	<i>Saved money x1000</i>	Displays the monetary savings in thousands compared to direct-on-line motor connection. This parameter is incremented when parameter 45.06 <i>Saved money</i> rolls over. This parameter is read-only (see parameter 45.21 <i>Energy calculations reset</i>).	-
	0...4294967295 thousands	Monetary savings in thousands of units.	1 = 1 unit
45.06	<i>Saved money</i>	Monetary savings compared to direct-on-line motor connection. This value is calculated by multiplying the saved energy in kWh by the currently active energy tariff (45.14 <i>Tariff selection</i>). When this parameter rolls over, parameter 45.05 <i>Saved money x1000</i> is incremented. This parameter is read-only (see parameter 45.21 <i>Energy calculations reset</i>).	-
	0.00...999.99 units	Monetary savings.	1 = 1 unit
45.07	<i>Saved amount</i>	Monetary savings compared to direct-on-line motor connection. This value is calculated by multiplying the saved energy in kWh by the currently active energy tariff (45.14 <i>Tariff selection</i>). This parameter is read-only (see parameter 45.21 <i>Energy calculations reset</i>).	-
	0.00... 21474836.47 units	Monetary savings.	1 = 1 unit
45.08	<i>CO2 reduction in kilotons</i>	Reduction in CO ₂ emissions in metric kilotons compared to direct-on-line motor connection. This value is incremented when parameter 45.09 <i>CO2 reduction in tons</i> rolls over. This parameter is read-only (see parameter 45.21 <i>Energy calculations reset</i>).	-
	0...65535 metric kilotons	Reduction in CO ₂ emissions in metric kilotons.	1 = 1 metric kiloton
45.09	<i>CO2 reduction in tons</i>	Reduction in CO ₂ emissions in metric tons compared to direct-on-line motor connection. This value is calculated by multiplying the saved energy in MWh by the value of parameter 45.18 <i>CO2 conversion factor</i> (by default, 0.5 metric tons/MWh). When this parameter rolls over, parameter 45.08 <i>CO2 reduction in kilotons</i> is incremented. This parameter is read-only (see parameter 45.21 <i>Energy calculations reset</i>).	-
	0.0...999.9 metric tons	Reduction in CO ₂ emissions in metric tons.	1 = 1 metric ton

No.	Name/Value	Description	Default FbEq 16
45.10	<i>Total saved CO₂</i>	Reduction in CO ₂ emissions in metric tons compared to direct-on-line motor connection. This value is calculated by multiplying the saved energy in MWh by the value of parameter <i>45.18 CO₂ conversion factor</i> (by default, 0.5 metric tons/MWh). This parameter is read-only (see parameter <i>45.21 Energy calculations reset</i>).	-
	0.0...214748364.7 metric tons	Reduction in CO ₂ emissions in metric tons.	1 = 1 metric ton
45.11	<i>Energy optimizer</i>	Enables/disables the energy optimization function. The function optimizes the motor flux so that total energy consumption and motor noise level are reduced when the drive operates below the nominal load. The total efficiency (motor and drive) can be improved by 1...20% depending on load torque and speed. Note: With a permanent magnet motor or a synchronous reluctance motor, energy optimization is always enabled regardless of this parameter.	<i>Disable</i>
	Disable	Energy optimization disabled.	0
	Enable	Energy optimization enabled.	1
45.12	<i>Energy tariff 1</i>	Defines energy tariff 1 (price of energy per kWh). Depending on the setting of parameter <i>45.14 Tariff selection</i> , either this value or <i>45.13 Energy tariff 2</i> is used for reference when monetary savings are calculated. Note: Tariffs are read only at the instant of selection, and are not applied retroactively.	1.000 units
	0.000... 4294967.295 units	Energy tariff 1.	-
45.13	<i>Energy tariff 2</i>	Defines energy tariff 2 (price of energy per kWh). See parameter <i>45.12 Energy tariff 1</i> .	2.000 units
	0.000... 4294967.295 units	Energy tariff 2.	-
45.14	<i>Tariff selection</i>	Selects (or defines a source that selects) which pre-defined energy tariff is used. 0 = <i>45.12 Energy tariff 1</i> 1 = <i>45.13 Energy tariff 2</i>	<i>Energy tariff 1</i>
	Energy tariff 1	0.	0
	Energy tariff 2	1.	1
	DI1	Digital input DI1 (<i>10.02 DI delayed status</i> , bit 0).	2
	DI2	Digital input DI2 (<i>10.02 DI delayed status</i> , bit 1).	3
	DI3	Digital input DI3 (<i>10.02 DI delayed status</i> , bit 2).	4
	DI4	Digital input DI4 (<i>10.02 DI delayed status</i> , bit 3).	5
	<i>Other [bit]</i>	Source selection (see <i>Terms and abbreviations</i>).	-

272 Parameters

No.	Name/Value	Description	Default FbEq 16
45.18	<i>CO2 conversion factor</i>	Defines a factor for conversion of saved energy into CO ₂ emissions (kg/kWh or tn/MWh). For example, <i>45.10 Total saved CO2 = 45.02 Saved kW hours × 45.18 CO2 conversion factor (tn/MWh)</i> .	0.500 tn/MWh
	0.000...65.535 tn/MWh	Factor for conversion of saved energy into CO ₂ emissions.	1 = 1 tn/MWh
45.19	<i>Comparison power</i>	Actual power that the motor absorbs when connected direct-on-line and operating the application. The value is used for reference when energy savings are calculated. Note: The accuracy of the energy savings calculation is directly dependent on the accuracy of this value. If nothing is entered here, then the nominal motor power is used by the calculation, but that may inflate the energy savings reported as many motors do not absorb nameplate power.	0.00 kW
	0.00...100000.00 kW	Motor power.	1 = 1 kW
45.21	<i>Energy calculations reset</i>	Resets the savings counter parameters <i>45.01...45.10</i> .	<i>Done</i>
	Done	Reset not requested (normal operation), or reset complete.	0
	Reset	Reset the savings counter parameters. The value reverts automatically to <i>Done</i> .	1
45.24	<i>Hourly peak power value</i>	Value of the peak power during the last hour, that is, the most recent 60 minutes after the drive has been powered up. The parameter is updated once every 10 minutes unless the hourly peak is found in the most recent 10 minutes. In that case, the values is shown immediately.	0.00 kW
	-3000.00 ... 3000.00 kW	Peak power value.	10 = 1 kW
45.25	<i>Hourly peak power time</i>	Time of the peak power value during the last hour.	00:00:00
		Time.	N/A
45.26	<i>Hourly total energy (resettable)</i>	Total energy consumption during the last hour, that is, the most recent 60 minutes. You can reset the value by setting it to zero.	0.00 kWh
	-3000.00 ... 3000.00 kWh	Total energy.	10 = 1 kWh
45.27	<i>Daily peak power value (resettable)</i>	Value of the peak power since midnight of the present day. You can reset the value by setting it to zero.	0.00 kW
	-3000.00 ... 3000.00 kW	Peak power value.	10 = 1 kW
45.28	<i>Daily peak power time</i>	Time of the peak power since midnight of the present day.	00:00:00
		Time.	N/A

No.	Name/Value	Description	Default FbEq 16
45.29	<i>Daily total energy (resettable)</i>	Total energy consumption since midnight of the present day. You can reset the value by setting it to zero.	0.00 kWh
	-30000.00 ... 30000.00 kWh	Total energy.	1 = 1 kWh
45.30	<i>Last day total energy</i>	Total energy consumption during the previous day, that is, between midnight of the previous day and midnight of the present day	0.00 kWh
	-30000.00 ... 30000.00 kWh	Total energy.	1 = 1 kWh
45.31	<i>Monthly peak power value (resettable)</i>	Value of the peak power during the present month, that is, since midnight of the first day of the present month. You can reset the value by setting it to zero.	0.00 kW
	-3000.00 ... 3000.00 kW	Peak power value.	10 = 1 kW
45.32	<i>Monthly peak power date</i>	Date of the peak power during the present month.	1/1/1980
	1/1/1980..6/5/2159	Date.	N/A
45.33	<i>Monthly peak power time</i>	Time of the peak power during the present month.	00:00:00
		Time.	N/A
45.34	<i>Monthly total energy (resettable)</i>	Total energy consumption from the beginning of the present month. You can reset the value by setting it to zero.	0.00 kWh
	-1000000.00 ... 1000000.00 kWh	Total energy.	0.01 = 1 kWh
45.35	<i>Last month total energy</i>	Total energy consumption during the previous month, that is, between midnight of the first day or the previous month and midnight of the first day of the present month.	0.00 kWh
	-1000000.00 ... 1000000.00 kWh		0.01 = 1 kWh
45.36	<i>Lifetime peak power value</i>	Value of the peak power over the drive lifetime.	0.00 kW
	-3000.00 ... 3000.00 kW	Peak power value.	10 = 1 kW
45.37	<i>Lifetime peak power date</i>	Date of the peak power over the drive lifetime.	1/1/1980
		Date.	N/A
45.38	<i>Lifetime peak power time</i>	Time of the peak power over the drive lifetime.	00:00:00
		Time.	N/A

274 Parameters

No.	Name/Value	Description	Default FbEq 16
<i>46 Monitoring/scaling settings</i>		Speed supervision settings; actual signal filtering; general scaling settings.	
<i>46.01</i>	<i>Speed scaling</i>	Defines the maximum speed value used to define the acceleration ramp rate and the initial speed value used to define the deceleration ramp rate (see parameter group <i>23 Speed reference ramp</i>). The speed acceleration and deceleration ramp times are therefore related to this value (not to parameter <i>30.12 Maximum speed</i>). Also defines the 16-bit scaling of speed-related parameters. The value of this parameter corresponds to 20000 in eg. fieldbus communication.	1500.00 rpm
	0.10...30000.00 rpm	Acceleration/deceleration terminal/initial speed.	1 = 1 rpm
<i>46.02</i>	<i>Frequency scaling</i>	Defines the maximum frequency value used to define the acceleration ramp rate and the initial frequency value used to define deceleration ramp rate (see parameter group <i>28 Frequency reference chain</i>). The frequency acceleration and deceleration ramp times are therefore related to this value (not to parameter <i>30.14 Maximum frequency</i>). Also defines the 16-bit scaling of frequency-related parameters. The value of this parameter corresponds to 20000 in eg. fieldbus communication.	50.00 Hz
	0.10...1000.00 Hz	Acceleration/deceleration terminal/initial frequency.	10 = 1 Hz
<i>46.03</i>	<i>Torque scaling</i>	Defines the 16-bit scaling of torque parameters. The value of this parameter (in percent of nominal motor torque) corresponds to 10000 in eg. fieldbus communication.	100.0%
	0.1...1000.0%	Torque corresponding to 10000 on fieldbus.	10 = 1%
<i>46.04</i>	<i>Power scaling</i>	Defines the 16-bit scaling of power parameters. The value of this parameter corresponds to 10000 in the fieldbus communication. The unit is selected by parameter <i>96.16 Unit selection</i> . (For 32-bit scaling see <i>46.43 Power decimals</i>)	1000.00
	0.10...30000.00	Power corresponding to 10000 on fieldbus.	1 = 1 unit
<i>46.05</i>	<i>Current scaling</i>	Defines the 16-bit scaling of current parameters. The value of this parameter corresponds to 10000 in fieldbus, master/follower, etc. communication. (For 32-bit scaling see <i>46.44 Current decimals</i>)	10000 A
	0...30000 A	Current corresponding to 10000 on fieldbus.	1 = 1 A
<i>46.06</i>	<i>Speed ref zero scaling</i>	Defines a speed corresponding to a zero reference received from fieldbus (either the embedded fieldbus interface, or interface FBA A). For example, with a setting of 500, the fieldbus reference range of 0...20000 would correspond to a speed of 500...[<i>46.01</i>] rpm. Note: This parameter is effective only with the ABB Drives communication profile.	0.00 rpm
	0.00 ... 30000.00 rpm	Speed corresponding to minimum fieldbus reference.	1 = 1 rpm

No.	Name/Value	Description	Default FbEq 16
46.07	<i>Frequency ref zero scaling</i>	Defines a frequency corresponding to a zero reference received from fieldbus (either the embedded fieldbus interface, or interface FBA A or FBA B). For example, with a setting of 30, the fieldbus reference range of 0...20000 would correspond to a speed of 30...[46.07] Hz. Note: This parameter is effective only with the ABB Drives communication profile.	0.00 Hz
	0.00 ... 1000.00 Hz	Speed corresponding to minimum fieldbus reference.	10 = 1 Hz
46.11	<i>Filter time motor speed</i>	Defines a filter time for signals <i>01.01 Motor speed used</i> .	500 ms
	2...20000 ms	Motor speed signal filter time.	1 = 1 ms
46.12	<i>Filter time output frequency</i>	Defines a filter time for signal <i>01.06 Output frequency</i> .	500 ms
	2...20000 ms	Output frequency signal filter time.	1 = 1 ms
46.13	<i>Filter time motor torque</i>	Defines a filter time for signal <i>01.10 Motor torque</i> .	100 ms
	2...20000 ms	Motor torque signal filter time.	1 = 1 ms
46.14	<i>Filter time power</i>	Defines a filter time for signal <i>01.14 Output power</i> .	100 ms
	2...20000 ms	Output power signal filter time.	1 = 1 ms
46.21	<i>At speed hysteresis</i>	Defines the "at setpoint" limits for speed control of the drive. When the difference between reference (<i>22.87 Speed reference act 7</i>) and the speed (<i>24.02 Used speed feedback</i>) is smaller than <i>46.21 At speed hysteresis</i> , the drive is considered to be "at setpoint". This is indicated by bit 8 of <i>06.11 Main status word</i> .	50.00 rpm
	0.00...30000.00 rpm	Limit for "at setpoint" indication in speed control.	See par. 46.01

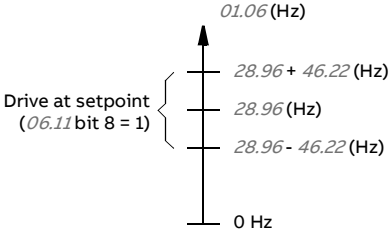
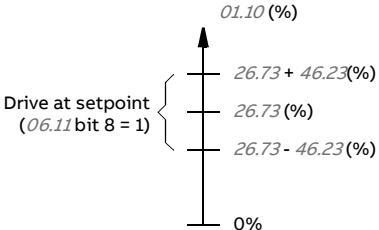

276 Parameters

No.	Name/Value	Description	Default FbEq 16
46.22	<i>At frequency hysteresis</i>	<p>Defines the “at setpoint” limits for frequency control of the drive. When the absolute difference between reference (<i>28.96 Frequency ref ramp input</i>) and actual frequency (<i>01.06 Output frequency</i>) is smaller than <i>46.22 At frequency hysteresis</i>, the drive is considered to be “at setpoint”. This is indicated by bit 8 of <i>06.11 Main status word</i>.</p> 	2.00 Hz
	0.00...1000.00 Hz	Limit for “at setpoint” indication in frequency control.	See par. <i>46.02</i>
46.23	<i>At torque hysteresis</i>	<p>Defines the “at setpoint” limits for torque control of the drive. When the absolute difference between reference (<i>26.73 Torque reference act 4</i>) and actual torque (<i>01.10 Motor torque</i>) is smaller than <i>46.23 At torque hysteresis</i>, the drive is considered to be “at setpoint”. This is indicated by bit 8 of <i>06.11 Main status word</i></p> 	5.0%
	0.0...300.0%	Limit for “at setpoint” indication in torque control.	See par. <i>46.03</i>
46.31	<i>Above speed limit</i>	Defines the trigger level for “above limit” indication in speed control. This is indicated by bit 10 of parameter <i>06.11</i> and parameter <i>06.17</i> . When actual speed exceeds the limit, bit 10 of <i>06.17 Drive status word 2</i> is set.	1500.00 rpm
	0.00...30000.00 rpm	“Above limit” indication trigger level for speed control.	See par. <i>46.01</i>

No.	Name/Value	Description	Default FbEq 16
46.32	<i>Above frequency limit</i>	Defines the trigger level for “above limit” indication in frequency control. This is indicated by bit 10 of parameter 06.11 and parameter 06.17. When actual frequency exceeds the limit, bit 10 of 06.17 Drive status word 2 is set.	50.00 Hz
	0.00...1000.00 Hz	“Above limit” indication trigger level for frequency control.	See par. 46.02
46.33	<i>Above torque limit</i>	Defines the trigger level for “above limit” indication in torque control. This is indicated by bit 10 of parameter 06.11 and parameter 06.17. When actual torque exceeds the limit, bit 10 of 06.17 Drive status word 2 is set.	300.0%
	0.0...1600.0%	“Above limit” indication trigger level for torque control.	See par. 46.03
46.41	<i>kWh pulse scaling</i>	Defines the trigger level for the “kWh pulse” on for 50 ms. The output of the pulse is bit 9 of 05.22 Diagnostic word 3.	1.000 kWh
	0.001... 1000.000 kWh	“kWh pulse” on trigger level.	1 = 1 kWh
46.43	<i>Power decimals</i>	Defines the number of display decimals places and 32-bit scaling of power-related parameters. The value of this parameter corresponds to the number of decimals assumed in the 32-bit integer fieldbus communication (for 16-bit scaling see 46.04 Power scaling).	2
	0...3	Number of decimals.	1 = 1
46.44	<i>Current decimals</i>	Defines the number of display decimals places and 32-bit scaling of current-related parameters. The value of this parameter corresponds to the number of decimals assumed in the 32-bit integer fieldbus communication (for 16-bit scaling see 46.05 Current scaling).	1
	0...3	Number of decimals.	1 = 1
47 Data storage		Data storage parameters that can be written to and read from using other parameters' source and target settings. Note that there are different storage parameters for different data types. See also section <i>Data storage parameters</i> (page 103).	
47.01	<i>Data storage 1 real32</i>	Data storage parameter 1. Parameters 47.01...47.04 are real 32-bit numbers that can be used as source values of other parameters.	0.000
	-2147483.008... 2147483.008	32-bit real (floating point) number.	-
47.02	<i>Data storage 2 real32</i>	Data storage parameter 2. See also parameter 47.01.	0.000
	-2147483.008... 2147483.008	32-bit real (floating point) number.	-

278 Parameters

No.	Name/Value	Description	Default FbEq 16
47.03	<i>Data storage 3 real32</i>	Data storage parameter 3. See also parameter 47.01.	0.000
	-2147483.008... 2147483.008	32-bit real (floating point) number.	-
47.04	<i>Data storage 4 real32</i>	Data storage parameter 4. See also parameter 47.01.	0.000
	-2147483.008... 2147483.008	32-bit real (floating point) number.	-
47.11	<i>Data storage 1 int32</i>	Data storage parameter 9.	0
	-2147483648... 2147483647	32-bit integer.	-
47.12	<i>Data storage 2 int32</i>	Data storage parameter 10.	0
	-2147483648... 2147483647	32-bit integer.	-
47.13	<i>Data storage 3 int32</i>	Data storage parameter 11.	0
	-2147483648... 2147483647	32-bit integer.	-
47.14	<i>Data storage 4 int32</i>	Data storage parameter 12.	0
	-2147483648... 2147483647	32-bit integer.	-
47.21	<i>Data storage 1 int16</i>	Data storage parameter 17.	0
	-32768...32767	16-bit data.	1 = 1
47.22	<i>Data storage 2 int16</i>	Data storage parameter 18.	0
	-32768...32767	16-bit data.	1 = 1
47.23	<i>Data storage 3 int16</i>	Data storage parameter 19.	0
	-32768...32767	16-bit data.	1 = 1
47.24	<i>Data storage 4 int16</i>	Data storage parameter 20.	0
	-32768...32767	16-bit data.	1 = 1
<i>49 Panel port communication</i>		Communication settings for the control panel port on the drive.	
49.01	<i>Node ID number</i>	Defines the node ID of the drive. All devices connected to the network must have a unique node ID. Note: For networked drives, it is advisable to reserve ID 1 for spare/replacement drives. Note: Changes to this parameter take effect after the control unit is rebooted or the new settings validated by parameter 49.06 <i>Refresh settings</i> .	1
	1...32	Node ID.	1 = 1
49.03	<i>Baud rate</i>	Defines the transfer rate of the link. Note: Changes to this parameter take effect after the control unit is rebooted or the new settings validated by parameter 49.06 <i>Refresh settings</i> .	115.2 kbps
	38.4 kbps	38.4 kbit/s.	1
	57.6 kbps	57.6 kbit/s.	2
	86.4 kbps	86.4 kbit/s.	3

No.	Name/Value	Description	Default FbEq 16
	115.2 kbps	115.2 kbit/s.	4
	230.4 kbps	230.4 kbit/s.	5
49.04	<i>Communication loss time</i>	Sets a timeout for control panel (or PC tool) communication. If a communication break lasts longer than the timeout, the action specified by parameter 49.05 <i>Communication loss action</i> is taken. Note: Changes to this parameter take effect after the control unit is rebooted or the new settings validated by parameter 49.06 <i>Refresh settings</i> .	10.0 s
	0.3...3000.0 s	Panel/PC tool communication timeout.	10 = 1 s
49.05	<i>Communication loss action</i>	Selects how the drive reacts to a control panel (or PC tool) communication break. Note: Changes to this parameter take effect after the control unit is rebooted or the new settings validated by parameter 49.06 <i>Refresh settings</i> .	<i>Fault</i>
	No action	No action taken.	0
	Fault	Drive trips on 7081 <i>Control panel loss</i> .	1
	Last speed	Drive generates an A7EE <i>Panel loss</i> warning and freezes the speed to the level the drive was operating at. The speed is determined on the basis of actual speed using 850 ms low-pass filtering.  WARNING! Make sure that it is safe to continue operation in case of a communication break.	2
	Speed ref safe	Drive generates an A7EE <i>Panel loss</i> warning and sets the speed to the speed defined by parameter 22.41 <i>Speed ref safe</i> (or 28.41 <i>Frequency ref safe</i> when frequency reference is being used).  WARNING! Make sure that it is safe to continue operation in case of a communication break.	3
49.06	<i>Refresh settings</i>	Applies the settings of parameters 49.01...49.05. Note: Refreshing may cause a communication break, so reconnecting the drive may be required.	<i>Done</i>
	Done	Refresh done or not requested.	0
	Configure	Refresh parameters 49.01...49.05. The value reverts automatically to <i>Done</i> .	1
49.19	<i>Basic panel home view 1</i>	Selects the parameters that are shown in <i>Home view 1</i> of the integrated or Basic panel (ACS-BP-S).	<i>Auto</i>
	Auto	Shows the factory default parameters.	0
	Motor speed used	01.01 <i>Motor speed used</i>	1
	Output frequency	01.06 <i>Output frequency</i>	3
	Motor current	01.07 <i>Motor current</i>	4
	Motor current % of motor nominal	01.08 <i>Motor current % of motor nom</i>	5
	Motor torque	01.10 <i>Motor torque</i>	6
	DC voltage	01.11 <i>DC voltage</i>	7
	Output power	01.14 <i>Output power</i>	8
	Speed ref ramp in	23.01 <i>Speed ref ramp input</i>	10
	Speed ref ramp out	23.02 <i>Speed ref ramp output</i>	11

280 Parameters

No.	Name/Value	Description	Default FbEq 16																
	Speed ref used	24.01 Used speed reference	12																
	Freq ref used	28.02 Frequency ref ramp output	14																
	Process PID out	40.01 Process PID output actual	16																
	Temp sensor 1 excitation	The output is used to feed an excitation current to the temperature sensor 1, see parameter 35.11 Temperature 1 source. See also section <i>Motor thermal protection</i> (page 93).	20																
	Abs motor speed used	01.61 Abs motor speed used	26																
	Abs motor speed %	01.62 Abs motor speed %	27																
	Abs output frequency	01.63 Abs output frequency	28																
	Abs motor torque	01.64 Abs motor torque	30																
	Abs output power	01.66 Abs output power	31																
	Abs motor shaft power	01.68 Abs motor shaft power	32																
	External PID1 out	71.01 External PID act value	33																
	AO1 data storage	13.91 AO1 data storage.	37																
	<i>Other</i>																		
49.20	<i>Basic panel home view 2</i>	Selects the parameters that are shown in <i>Home view 2</i> of the integrated or Basic panel (ACS-BP-S). See parameter 49.19 for the selection.	<i>Auto</i>																
49.21	<i>Basic panel home view 3</i>	Selects the parameters that are shown in <i>Home view 3</i> of the integrated or Basic panel (ACS-BP-S). See parameter 49.19 for the selection.	<i>Auto</i>																
49.30	<i>Basic panel menu hiding</i>	Parameter to hide main level menus in the integrated or Basic panel (ACS-BP-S). Values are: 0 = Menu visible 1 = Menu hidden	0000h																
<table border="1"> <thead> <tr> <th>Bit</th> <th>Value</th> </tr> </thead> <tbody> <tr> <td>0</td> <td>Motor data</td> </tr> <tr> <td>1</td> <td>Motor control</td> </tr> <tr> <td>2</td> <td>Control macros</td> </tr> <tr> <td>3</td> <td>Diagnostics</td> </tr> <tr> <td>4</td> <td>Reserved</td> </tr> <tr> <td>5</td> <td>Parameters</td> </tr> <tr> <td>6...15</td> <td>Reserved</td> </tr> </tbody> </table>		Bit	Value	0	Motor data	1	Motor control	2	Control macros	3	Diagnostics	4	Reserved	5	Parameters	6...15	Reserved		
Bit	Value																		
0	Motor data																		
1	Motor control																		
2	Control macros																		
3	Diagnostics																		
4	Reserved																		
5	Parameters																		
6...15	Reserved																		
0000h...FFFFh			1=1																



No.	Name/Value	Description	Default FbEq 16
49.219	<i>Basic panel home view 4</i>	Selects the parameters that are shown in <i>Home view 4</i> of the integrated or Basic panel (ACS-BP-S). For the selections, see parameter 49.19.	<i>Auto</i>
49.220	<i>Basic panel home view 5</i>	Selects the parameters that are shown in <i>Home view 5</i> of the integrated or Basic panel (ACS-BP-S). For the selections, see parameter 49.19.	<i>Auto</i>
49.221	<i>Basic panel home view 6</i>	Selects the parameters that are shown in <i>Home view 6</i> of the integrated or Basic panel (ACS-BP-S). For the selections, see parameter 49.19.	<i>Auto</i>
<i>58 Embedded fieldbus</i>		Configuration of the embedded fieldbus (EFB) interface. See chapter <i>Fieldbus control through the embedded fieldbus interface (EFB)</i> .	
58.01	<i>Protocol enable</i>	Enables/disables the embedded fieldbus interface and selects the protocol to use.	<i>None</i>
	None	None (communication disabled).	0
	Modbus RTU	Embedded fieldbus interface is enabled and uses the Modbus RTU protocol.	1
58.02	<i>Protocol ID</i>	Displays the protocol ID and revision. This parameter is read-only.	-
		Protocol ID and revision.	1 = 1
58.03	<i>Node address</i>	Defines the node address of the drive on the fieldbus link. Values 1...247 are allowable. Two devices with the same address are not allowed on-line. Changes to this parameter take effect after the control unit is rebooted or the new settings validated by parameter 58.06 <i>Communication control(Refresh settings)</i> .	1
	0...255	Node address (values 1...127 are allowed).	1=1
58.04	<i>Baud rate</i>	Selects the transfer rate of the fieldbus link. When using selection <i>Autodetect</i> , the parity setting of the bus must be known and configured in parameter 58.05 <i>Parity</i> . When parameter 58.04 <i>Baud rate</i> is set to <i>Autodetect</i> , the EFB settings must be refreshed with parameter 58.06. The bus is monitored for a period of time and the detected baud rate is set as the value of this parameter. Changes to this parameter take effect after the control unit is rebooted or the new settings validated by parameter 58.06 <i>Communication control(Refresh settings)</i> .	<i>19.2 kbps</i>
	Autodetect	Baud rate detected automatically.	0
	4.8 kbps	4.8 kbit/s.	1
	9.6 kbps	9.6 kbit/s.	2
	19.2 kbps	19.2 kbit/s.	3
	38.4 kbps	38.4 kbit/s.	4
	57.6 kbps	57.6 kbit/s.	5
	76.8 kbps	76.8 kbit/s.	6

282 Parameters

No.	Name/Value	Description	Default FbEq 16
	115.2 kbps	115.2 kbit/s.	7
58.05	<i>Parity</i>	Selects the type of parity bit and number of stop bits. Changes to this parameter take effect after the control unit is rebooted or the new settings validated by parameter 58.06 <i>Communication control (Refresh settings)</i> .	8 <i>EVEN 1</i>
	8 NONE 1	Eight data bits, no parity bit, one stop bit.	0
	8 NONE 2	Eight data bits, no parity bit, two stop bits.	1
	8 EVEN 1	Eight data bits, even parity bit, one stop bit.	2
	8 ODD 1	Eight data bits, odd parity bit, one stop bit.	3
58.06	<i>Communication control</i>	Takes changed EFB settings in use, or activates silent mode.	<i>Enabled</i>
	Enabled	Normal operation.	0
	Refresh settings	Refreshes settings (Modbus parameters 58.01...58.05, 58.14...58.17, 58.25, 58.28...58.34) and takes changed EFB configuration settings in use. Reverts automatically to <i>Enabled</i> .	1
	Silent mode	Activates silent mode (no messages are transmitted). Silent mode can be terminated by activating the <i>Refresh settings</i> selection of this parameter.	2

No.	Name/Value	Description	Default FbEq 16																																																			
58.07	<i>Communication diagnostics</i>	Displays the status of the EFB communication. This parameter is read-only. Note that the name is only visible when the error is present (bit value is 1).	-																																																			
		<table border="1"> <thead> <tr> <th>Bit</th> <th>Name</th> <th>Description</th> </tr> </thead> <tbody> <tr> <td>0</td> <td>Init failed</td> <td>1 = EFB initialization failed</td> </tr> <tr> <td>1</td> <td>Addr config err</td> <td>1 = Node address not allowed by protocol</td> </tr> <tr> <td>2</td> <td>Silent mode</td> <td>1 = Drive not allowed to transmit 0 = Drive allowed to transmit</td> </tr> <tr> <td>3</td> <td>Autobauding</td> <td></td> </tr> <tr> <td>4</td> <td>Wiring error</td> <td>1 = Errors detected (A/B wires possibly swapped)</td> </tr> <tr> <td>5</td> <td>Parity error</td> <td>1 = Error detected: check parameters 58.04 and 58.05</td> </tr> <tr> <td>6</td> <td>Baud rate error</td> <td>1 = Error detected: check parameters 58.05 and 58.04</td> </tr> <tr> <td>7</td> <td>No bus activity</td> <td>1 = 0 bytes received during last 5 seconds</td> </tr> <tr> <td>8</td> <td>No packets</td> <td>1 = 0 packets (addressed to any device) detected during last 5 seconds</td> </tr> <tr> <td>9</td> <td>Noise or addressing error</td> <td>1 = Errors detected (interference, or another device with the same address on line)</td> </tr> <tr> <td>10</td> <td>Comm loss</td> <td>1 = 0 packets addressed to the drive received within timeout (58.16)</td> </tr> <tr> <td>11</td> <td>CW/Ref loss</td> <td>1 = No control word or references received within timeout (58.16)</td> </tr> <tr> <td>12</td> <td>Not active</td> <td>Reserved</td> </tr> <tr> <td>13</td> <td>Protocol 1</td> <td>Reserved</td> </tr> <tr> <td>14</td> <td>Protocol 2</td> <td>Reserved</td> </tr> <tr> <td>15</td> <td>Internal error</td> <td>1 = Internal errors detected</td> </tr> </tbody> </table>	Bit	Name	Description	0	Init failed	1 = EFB initialization failed	1	Addr config err	1 = Node address not allowed by protocol	2	Silent mode	1 = Drive not allowed to transmit 0 = Drive allowed to transmit	3	Autobauding		4	Wiring error	1 = Errors detected (A/B wires possibly swapped)	5	Parity error	1 = Error detected: check parameters 58.04 and 58.05	6	Baud rate error	1 = Error detected: check parameters 58.05 and 58.04	7	No bus activity	1 = 0 bytes received during last 5 seconds	8	No packets	1 = 0 packets (addressed to any device) detected during last 5 seconds	9	Noise or addressing error	1 = Errors detected (interference, or another device with the same address on line)	10	Comm loss	1 = 0 packets addressed to the drive received within timeout (58.16)	11	CW/Ref loss	1 = No control word or references received within timeout (58.16)	12	Not active	Reserved	13	Protocol 1	Reserved	14	Protocol 2	Reserved	15	Internal error	1 = Internal errors detected	
Bit	Name	Description																																																				
0	Init failed	1 = EFB initialization failed																																																				
1	Addr config err	1 = Node address not allowed by protocol																																																				
2	Silent mode	1 = Drive not allowed to transmit 0 = Drive allowed to transmit																																																				
3	Autobauding																																																					
4	Wiring error	1 = Errors detected (A/B wires possibly swapped)																																																				
5	Parity error	1 = Error detected: check parameters 58.04 and 58.05																																																				
6	Baud rate error	1 = Error detected: check parameters 58.05 and 58.04																																																				
7	No bus activity	1 = 0 bytes received during last 5 seconds																																																				
8	No packets	1 = 0 packets (addressed to any device) detected during last 5 seconds																																																				
9	Noise or addressing error	1 = Errors detected (interference, or another device with the same address on line)																																																				
10	Comm loss	1 = 0 packets addressed to the drive received within timeout (58.16)																																																				
11	CW/Ref loss	1 = No control word or references received within timeout (58.16)																																																				
12	Not active	Reserved																																																				
13	Protocol 1	Reserved																																																				
14	Protocol 2	Reserved																																																				
15	Internal error	1 = Internal errors detected																																																				
	0000h...FFFFh	EFB communication status.	1 = 1																																																			
58.08	<i>Received packets</i>	Displays a count of valid packets addressed to the drive. During normal operation, this number increases constantly. Can be reset from the control panel by keeping Reset down for over 3 seconds.	-																																																			
	0...4294967295	Number of received packets addressed to the drive.	1 = 1																																																			
58.09	<i>Transmitted packets</i>	Displays a count of valid packets transmitted by the drive. During normal operation, this number increases constantly. Can be reset from the control panel by keeping Reset down for over 3 seconds.	-																																																			
	0...4294967295	Number of transmitted packets.	1 = 1																																																			
58.10	<i>All packets</i>	Displays a count of valid packets addressed to any device on the bus. During normal operation, this number increases constantly. Can be reset from the control panel by keeping Reset down for over 3 seconds.	-																																																			
	0...4294967295	Number of all received packets.	1 = 1																																																			

284 Parameters

No.	Name/Value	Description	Default FbEq 16
58.11	<i>UART errors</i>	Displays a count of character errors received by the drive. An increasing count indicates a configuration problem on the bus. Can be reset from the control panel by keeping Reset down for over 3 seconds.	-
	0...4294967295	Number of UART errors.	1 = 1
58.12	<i>CRC errors</i>	Displays a count of packets with a CRC error received by the drive. An increasing count indicates interference on the bus. Can be reset from the control panel by keeping Reset down for over 3 seconds.	-
	0...4294967295	Number of CRC errors.	1 = 1
58.14	<i>Communication loss action</i>	Selects how the drive reacts to an EFB communication break. The drive does not trip if only reference is coming from EFB and the communication is lost. Changes to this parameter take effect after the control unit is rebooted or the new settings validated by parameter 58.06 <i>Communication control</i> (<i>Refresh settings</i>). See also parameters 58.15 <i>Communication loss mode</i> and 58.16 <i>Communication loss time</i> .	<i>Fault</i>
	No action	No action taken (monitoring disabled).	0
	Fault	Drive trips on 6681 <i>EFB comm loss</i> . This occurs only if control in the currently active control location is expected from the EFB.	1
	Last speed	Drive generates an A7CE <i>EFB comm loss</i> warning and freezes the speed to the level the drive was operating at. The speed is determined on the basis of actual speed using 850 ms low-pass filtering. This occurs only if control is expected from the EFB.  WARNING! Make sure that it is safe to continue operation in case of a communication break.	2
	Speed ref safe	Drive generates an A7CE <i>EFB comm loss</i> warning and sets the speed to the speed defined by parameter 22.41 <i>Speed ref safe</i> (or 28.41 <i>Frequency ref safe</i> when frequency reference is being used). This occurs only if control is expected from the EFB.  WARNING! Make sure that it is safe to continue operation in case of a communication break.	3
	Fault always	Drive trips on 6681 <i>EFB comm loss</i> . This happens even though the drive is in a control location where the EFB start/stop or reference is not used.	4
	Warning	Drive generates an A7CE <i>EFB comm loss</i> warning. This occurs even though no control is expected from the EFB.  WARNING! Make sure that it is safe to continue operation in case of a communication break.	5

No.	Name/Value	Description	Default FbEq 16
58.15	<i>Communication loss mode</i>	Defines which message types reset the timeout counter for detecting an EFB communication loss. Changes to this parameter take effect after the control unit is rebooted or the new settings validated by parameter 58.06 <i>Communication control(Refresh settings)</i> . See also parameters 58.14 <i>Communication loss action</i> and 58.16 <i>Communication loss time</i> .	<i>Cw / Ref1 / Ref2</i>
	Any message	Any message addressed to the drive resets the timeout.	1
	Cw / Ref1 / Ref2	A write of the control word or a reference resets the timeout.	2
58.16	<i>Communication loss time</i>	Sets a timeout for EFB communication. If a communication break lasts longer than the timeout, the action specified by parameter 58.14 <i>Communication loss action</i> is taken. Changes to this parameter take effect after the control unit is rebooted or the new settings validated by parameter 58.06 <i>Communication control(Refresh settings)</i> . See also parameter 58.15 <i>Communication loss mode</i> . Notes: • There is a 30-second boot-up delay immediately after power-up. During the delay, the communication break monitoring is disabled.	3.0 s
	0.0...6000.0 s	EFB communication timeout.	1 = 1
58.17	<i>Transmit delay</i>	Defines a minimum response delay in addition to any fixed delay imposed by the protocol. Changes to this parameter take effect after the control unit is rebooted or the new settings validated by parameter 58.06 <i>Communication control(Refresh settings)</i> .	0 ms
	0...65535 ms	Minimum response delay.	1 = 1
58.18	<i>EFB control word</i>	Displays the raw (unmodified) status word sent by the drive to the Modbus controller. For debugging purposes. This parameter is read-only.	-
	0...FFFFFFFFh	Control word sent by the controller to the drive.	1 = 1
58.19	<i>EFB status word</i>	Displays the raw (unmodified) status word for debugging purposes. This parameter is read-only.	-
	0...FFFFFFFFh	Status word sent by the drive to the controller.	1 = 1
58.25	<i>Control profile</i>	Defines the communication profile used by the protocol. Changes to this parameter take effect after the control unit is rebooted or the new settings validated by parameter 58.06 <i>Communication control(Refresh settings)</i> .	<i>ABB Drives</i>
	ABB Drives	ABB Drives control profile (with a 16-bit control word)	0
	DCU Profile	DCU control profile (with a 16 or 32-bit control word)	5

No.	Name/Value	Description	Default FbEq 16										
58.26	<i>EFB ref1 type</i>	Selects the type and scaling of reference 1 received through the embedded fieldbus interface. The scaled reference is displayed by <i>03.09 EFB reference 1</i> .	<i>Speed or frequency</i>										
	Speed or frequency	Type and scaling is chosen automatically according to the currently active operation mode as follows. <table border="1" style="margin-left: 20px;"> <thead> <tr> <th>Operation mode (see par. 19.01)</th> <th>Reference 1 type</th> </tr> </thead> <tbody> <tr> <td>Speed control</td> <td><i>Speed</i></td> </tr> <tr> <td>Torque control</td> <td><i>Speed</i></td> </tr> <tr> <td>Frequency control</td> <td><i>Frequency</i></td> </tr> </tbody> </table>	Operation mode (see par. 19.01)	Reference 1 type	Speed control	<i>Speed</i>	Torque control	<i>Speed</i>	Frequency control	<i>Frequency</i>	0		
Operation mode (see par. 19.01)	Reference 1 type												
Speed control	<i>Speed</i>												
Torque control	<i>Speed</i>												
Frequency control	<i>Frequency</i>												
	Transparent	No scaling is applied.	1										
	General	Generic reference without a specific unit. Scaling: 1 = 100.	2										
	Torque	Torque reference. The scaling is defined by parameter <i>46.03 Torque scaling</i> .	3										
	Speed	Speed reference. The scaling is defined by parameter <i>46.01 Speed scaling</i> .	4										
	Frequency	Frequency reference. The scaling is defined by parameter <i>46.02 Frequency scaling</i> .	5										
58.27	<i>EFB ref2 type</i>	Selects the type and scaling of reference 2 received through the embedded fieldbus interface. The scaled reference is displayed by <i>03.10 EFB reference 2</i> .	<i>Speed or frequency</i>										
58.28	<i>EFB act1 type</i>	Selects the type/source and scaling of actual value 1 transmitted to the fieldbus.network through the embedded fieldbus interface.	<i>Speed or frequency</i>										
	Speed or frequency	Type and scaling is chosen automatically according to the currently active operation mode as follows: <table border="1" style="margin-left: 20px;"> <thead> <tr> <th>Operation mode (see par. 19.01)</th> <th>Actual 1 type (source)</th> <th>Scaling</th> </tr> </thead> <tbody> <tr> <td>Speed control</td> <td rowspan="2"><i>Speed (01.01 Motor speed usec)</i></td> <td rowspan="2"><i>46.01 Speed scaling</i></td> </tr> <tr> <td>Torque control</td> </tr> <tr> <td>Frequency control</td> <td><i>Frequency (01.06 Output frequency)</i></td> <td><i>46.02 Frequency scaling</i></td> </tr> </tbody> </table>	Operation mode (see par. 19.01)	Actual 1 type (source)	Scaling	Speed control	<i>Speed (01.01 Motor speed usec)</i>	<i>46.01 Speed scaling</i>	Torque control	Frequency control	<i>Frequency (01.06 Output frequency)</i>	<i>46.02 Frequency scaling</i>	0
Operation mode (see par. 19.01)	Actual 1 type (source)	Scaling											
Speed control	<i>Speed (01.01 Motor speed usec)</i>	<i>46.01 Speed scaling</i>											
Torque control													
Frequency control	<i>Frequency (01.06 Output frequency)</i>	<i>46.02 Frequency scaling</i>											
	Transparent	The value selected by parameter <i>58.31 EFB act1 transparent source</i> is sent as actual value 1. No scaling is applied (the 16-bit scaling is 1 = 1 unit).	1										
	General	The value selected by parameter <i>58.31 EFB act1 transparent source</i> is sent as actual value 1 with a 16-bit scaling of 100 =1 unit (ie. integer and two decimals).	2										
	Torque	<i>01.10 Motor torque</i> is sent as actual value 1. Scaling is defined by parameter <i>46.03 Torque scaling</i> .	3										

No.	Name/Value	Description	Default FbEq 16										
	Speed	<i>01.01 Motor speed used</i> is sent as actual value 1. Scaling is defined by parameter <i>46.01 Speed scaling</i> .	4										
	Frequency	<i>01.06 Output frequency</i> is sent as actual value 1. Scaling is defined by parameter <i>46.02 Frequency scaling</i> .	5										
<i>58.29</i>	<i>EFB act2 type</i>	Selects the type/source and scaling of actual value 2 transmitted to the fieldbus network through the embedded fieldbus interface.	<i>Transparent</i>										
	Speed or frequency	Type/source and scaling are chosen automatically according to the currently active operation mode as follows:	0										
<table border="1" style="margin-left: auto; margin-right: auto;"> <thead> <tr> <th>Operation mode (see par. <i>19.01</i>)</th> <th>Actual 1 type (source)</th> <th>Scaling</th> </tr> </thead> <tbody> <tr> <td>Speed control</td> <td rowspan="2" style="text-align: center;"><i>Speed</i> (<i>01.01 Motor speed used</i>)</td> <td rowspan="2" style="text-align: center;"><i>46.01 Speed scaling</i></td> </tr> <tr> <td>Torque control</td> </tr> <tr> <td>Frequency control</td> <td style="text-align: center;"><i>Frequency</i> (<i>01.06 Output frequency</i>)</td> <td style="text-align: center;"><i>46.02 Frequency scaling</i></td> </tr> </tbody> </table>				Operation mode (see par. <i>19.01</i>)	Actual 1 type (source)	Scaling	Speed control	<i>Speed</i> (<i>01.01 Motor speed used</i>)	<i>46.01 Speed scaling</i>	Torque control	Frequency control	<i>Frequency</i> (<i>01.06 Output frequency</i>)	<i>46.02 Frequency scaling</i>
Operation mode (see par. <i>19.01</i>)	Actual 1 type (source)	Scaling											
Speed control	<i>Speed</i> (<i>01.01 Motor speed used</i>)	<i>46.01 Speed scaling</i>											
Torque control													
Frequency control	<i>Frequency</i> (<i>01.06 Output frequency</i>)	<i>46.02 Frequency scaling</i>											
	Transparent	The value selected by parameter <i>58.32 EFB act2 transparent source</i> is sent as actual value 2. No scaling is applied (the 16-bit scaling is 1 = 1 unit).	1										
	General	The value selected by parameter <i>58.32 EFB act2 transparent source</i> is sent as actual value 2 with a 16-bit scaling of 100 = 1 unit (i.e. integer and two decimals).	2										
	Torque	<i>01.10 Motor torque</i> is sent as actual value 2. Scaling is defined by parameter <i>46.03 Torque scaling</i> .	3										
	Speed	<i>01.01 Motor speed used</i> is sent as actual value 2. Scaling is defined by parameter <i>46.01 Speed scaling</i> .	4										
	Frequency	<i>01.06 Output frequency</i> is sent as actual value 2. Scaling is defined by parameter <i>46.02 Frequency scaling</i> .	5										
<i>58.31</i>	<i>EFB act1 transparent source</i>	Selects the source of actual value 1 when parameter <i>58.28 EFB act1 type</i> is set to <i>Transparent</i> .	<i>Not selected</i>										
	Not selected	None.	0										
	<i>Other</i>	Source selection (see <i>Terms and abbreviations</i>).	-										
<i>58.32</i>	<i>EFB act2 transparent source</i>	Selects the source of actual value 1 when parameter <i>58.29 EFB act2 type</i> is set to <i>Transparent</i> .	<i>Not selected</i>										
	Not selected	None.	0										
	<i>Other</i>	Source selection (see <i>Terms and abbreviations</i>).	-										

No.	Name/Value	Description	Default FbEq 16
58.33	Addressing mode	Defines the mapping between parameters and holding registers in the 400101...465535 Modbus register range. Changes to this parameter take effect after the control unit is rebooted or the new settings validated by parameter 58.06 Communication control (Refresh settings).	Mode 0
	Mode 0	16-bit values (groups 1...99, indexes 1...99): Register address = 400000 + 100 × parameter group + parameter index. For example, parameter 22.80 would be mapped to register 400000 + 2200 + 80 = 402280. 32-bit values (groups 1...99, indexes 1...99): Register address = 420000 + 200 × parameter group + 2 × parameter index. For example, parameter 22.80 would be mapped to register 420000 + 4400 + 160 = 424560.	0
	Mode 1	16-bit values (groups 1...255, indexes 1...255): Register address = 400000 + 256 × parameter group + parameter index. For example, parameter 22.80 would be mapped to register 400000 + 5632 + 80 = 405712.	1
	Mode 2	32-bit values (groups 1...127, indexes 1...255): Register address = 400000 + 512 × parameter group + 2 × parameter index. For example, parameter 22.80 would be mapped to register 400000 + 11264 + 160 = 411424.	2
58.34	Word order	Selects in which order 16-bit registers of 32-bit parameters are transferred. For each register, the first byte contains the high order byte and the second byte contains the low order byte. Changes to this parameter take effect after the control unit is rebooted or the new settings validated by parameter 58.06 Communication control (Refresh settings).	LO-HI
	HI-LO	The first register contains the high order word, the second contains the low order word.	0
	LO-HI	The first register contains the low order word, the second contains the high order word.	1
58.101	Data I/O 1	Defines the address in the drive which the Modbus master accesses when it reads from or writes to the register address corresponding to Modbus register 1 (400001). The master defines the type of the data (input or output). The value is transmitted in a Modbus frame consisting of two 16-bit words. If the value is 16-bit, it is transmitted in the LSW (least significant word). If the value is 32-bit, the subsequent parameter is also reserved for it and must be set to <i>None</i> .	CW 16bit
	None	No mapping, register is always zero.	0
	CW 16bit	ABB Drives, CiA402 and Transparent 16 profiles: 16-bit control word; DCU Profile: lower 16 bits of the DCU control word	1
	Ref1 16bit	Reference REF1 (16 bits)	2

No.	Name/Value	Description	Default FbEq 16
	Ref2 16bit	Reference REF2 (16 bits)	3
	SW 16bit	<i>ABB Drives</i> profile: 16-bit ABB drives status word; <i>DCU Profile</i> : lower 16 bits of the DCU status word	4
	Act1 16bit	Actual value ACT1 (16 bits)	5
	Act2 16bit	Actual value ACT2 (16 bits)	6
	CW 32bit	Control Word (32 bits)	11
	Ref1 32bit	Reference REF1 (32 bits)	12
	Ref2 32bit	Reference REF2 (32 bits)	13
	SW 32bit	Status Word (32 bits)	14
	Act1 32bit	Actual value ACT1 (32 bits)	15
	Act2 32bit	Actual value ACT2 (32 bits)	16
	CW2 16bit	<i>ABB Drives</i> profile: not used; <i>DCU Profile</i> : upper 16 bits of the DCU control word	21
	SW2 16bit	<i>ABB Drives</i> profile: not used / always zero; <i>DCU Profile</i> : upper 16 bits of the DCU status word.	24
	RO/DIO control word	Parameter <i>10.99 RO/DIO control word</i> .	31
	AO1 data storage	Parameter <i>13.91 AO1 data storage</i> .	32
	Feedback data storage	Parameter <i>40.91 Feedback data storage</i> .	40
	Setpoint data storage	Parameter <i>40.92 Setpoint data storage</i>	41
	<i>Other</i>	Source selection (see <i>Terms and abbreviations</i>).	-
<i>58.102</i>	<i>Data I/O 2</i>	Defines the address in the drive which the Modbus master accesses when it reads from or writes to register address 400002. For the selections, see parameter <i>58.101 Data I/O 1</i> .	<i>Ref1 16bit</i>
<i>58.103</i>	<i>Data I/O 3</i>	Defines the address in the drive which the Modbus master accesses when it reads from or writes to register address 400003. For the selections, see parameter <i>58.101 Data I/O 1</i> .	<i>Ref2 16bit</i>
<i>58.104</i>	<i>Data I/O 4</i>	Defines the address in the drive which the Modbus master accesses when it reads from or writes to register address 400004. For the selections, see parameter <i>58.101 Data I/O 1</i> .	<i>SW 16bit</i>
<i>58.105</i>	<i>Data I/O 5</i>	Defines the address in the drive which the Modbus master accesses when it reads from or writes to register address 400005. For the selections, see parameter <i>58.101 Data I/O 1</i> .	<i>Act1 16bit</i>
<i>58.106</i>	<i>Data I/O 6</i>	Defines the address in the drive which the Modbus master accesses when it reads from or writes to register address 400006. For the selections, see parameter <i>58.101 Data I/O 1</i> .	<i>Act2 16bit</i>
<i>58.107</i>	<i>Data I/O 7</i>	Parameter selector for Modbus register address 400007. For the selections, see parameter <i>58.101 Data I/O 1</i> .	None
<i>58.108</i>	<i>Data I/O 8</i>	Parameter selector for Modbus register address 400008. For the selections, see parameter <i>58.101 Data I/O 1</i> .	None

290 Parameters

No.	Name/Value	Description	Default FbEq 16
58.109	Data I/O 9	Parameter selector for Modbus register address 400009. For the selections, see parameter 58.101 Data I/O 1.	None
58.110	Data I/O 10	Parameter selector for Modbus register address 400010. For the selections, see parameter 58.101 Data I/O 1.	None
58.111	Data I/O 11	Parameter selector for Modbus register address 400011. For the selections, see parameter 58.101 Data I/O 1.	None
58.112	Data I/O 12	Parameter selector for Modbus register address 400012. For the selections, see parameter 58.101 Data I/O 1.	None
58.113	Data I/O 13	Parameter selector for Modbus register address 400013. For the selections, see parameter 58.101 Data I/O 1.	None
58.114	Data I/O 14	Parameter selector for Modbus register address 400014. For the selections, see parameter 58.101 Data I/O 1.	None

71 External PID1		Configuration of external PID.	
71.01	External PID act value	See parameter 40.01 Process PID output actual.	-
71.02	Feedback act value	See parameter 40.02 Process PID feedback actual.	-
71.03	Setpoint act value	See parameter 40.03 Process PID setpoint actual.	-
71.04	Deviation act value	See parameter 40.04 Process PID deviation actual.	-
71.06	PID status word	Displays status information on process external PID control. This parameter is read-only.	-

Bit	Name	Value
0	PID active	1 = Process PID control active.
1	Reserved	
2	Output frozen	1 = Process PID controller output frozen. Bit is set if parameter 71.38 Output freeze enable is TRUE, or the deadband function is active (bit 9 is set).
3...6	Reserved	
7	Output limit high	1 = PID output is being limited by par. 40.37.
8	Output limit low	1 = PID output is being limited by par. 40.36.
9	Deadband active	1 = Deadband is active.
10...11	Reserved	
12	Internal setpoint active	1 = Internal setpoint active (see par. 40.16...40.16)
13...15	Reserved	

0000h...FFFFh	Process PID control status word.	1 = 1
71.07	PID operation mode	See parameter 40.07 Process PID operation mode. Off
71.08	Feedback 1 source	See parameter 40.08 Set 1 feedback 1 source. Not selected
71.11	Feedback filter time	See parameter 40.11 Set 1 feedback filter time. 0.000 s

No.	Name/Value	Description	Default FbEq 16
71.14	<i>Setpoint scaling</i>	Defines, together with parameter <i>71.15 Output scaling</i> , a general scaling factor for the external PID control chain. The scaling can be utilized when, for example, the process setpoint is input in Hz, and the output of the PID controller is used as an rpm value in speed control. In this case, this parameter might be set to 50, and parameter <i>71.15</i> to the nominal motor speed at 50 Hz. In effect, the output of the PID controller [<i>71.15</i>] when deviation (setpoint - feedback) = [<i>71.14</i>] and [<i>71.32</i>] = 1. Note: The scaling is based on the ratio between <i>71.14</i> and <i>71.15</i> . For example, the values 50 and 1500 would produce the same scaling as 1 and 3.	1500.00
	-200000.00... 200000.00	Process setpoint base.	1 = 1
71.15	<i>Output scaling</i>	See parameter <i>71.14 Setpoint scaling</i> .	1500.00
	-200000.00... 200000.00	Process PID controller output base.	1 = 1
71.16	<i>Setpoint 1 source</i>	See parameter <i>40.16 Set 1 setpoint 1 source</i> .	<i>Not selected</i>
71.19	<i>Internal setpoint sel1</i>	See parameter <i>40.19 Set 1 internal setpoint sel1</i> .	<i>Not selected</i>
71.20	<i>Internal setpoint sel2</i>	See parameter <i>40.20 Set 1 internal setpoint sel2</i> .	<i>Not selected</i>
71.21	<i>Internal setpoint 1</i>	See parameter <i>40.21 Set 1 internal setpoint 1</i> .	0.00 PID customer units
71.22	<i>Internal setpoint 2</i>	See parameter <i>40.22 Set 1 internal setpoint 2</i> .	0.00 PID customer units
71.23	<i>Internal setpoint 3</i>	See parameter <i>40.23 Set 1 internal setpoint 3</i> .	0.00 PID customer units
71.26	<i>Setpoint min</i>	See parameter <i>40.26 Set 1 setpoint min</i> .	0.00
71.27	<i>Setpoint max</i>	See parameter <i>40.27 Set 1 setpoint max</i> .	200000.00
71.31	<i>Deviation inversion</i>	See parameter <i>40.31 Set 1 deviation inversion</i> .	<i>Not inverted (Ref - Fbk)</i>
71.32	<i>Gain</i>	See parameter <i>40.32 Set 1 gain</i> .	1.00
71.33	<i>Integration time</i>	See parameter <i>40.33 Set 1 integration time</i> .	60.0 s
71.34	<i>Derivation time</i>	See parameter <i>40.34 Set 1 derivation time</i> .	0.000 s
71.35	<i>Derivation filter time</i>	See parameter <i>40.35 Set 1 derivation filter time</i> .	0.0 s
71.36	<i>Output min</i>	See parameter <i>40.36 Set 1 output min</i> .	-200000.00
71.37	<i>Output max</i>	See parameter <i>40.37 Set 1 output max</i> .	200000.00
71.38	<i>Output freeze enable</i>	See parameter <i>40.38 Set 1 output freeze enable</i> .	<i>Not selected</i>

292 Parameters

No.	Name/Value	Description	Default FbEq 16
71.39	<i>Deadband range</i>	The control program compares the absolute value of parameter <i>71.04 Deviation act value</i> to the deadband range defined by this parameter. If the absolute value is within the deadband range for the time period defined by parameter <i>71.40 Deadband delay</i> , PID's deadband mode is activated and <i>71.06 PID status word</i> ' bit 9 <i>Deadband active</i> is set. Then PID's output is frozen and <i>71.06 PID status word</i> bit 2 <i>Output frozen</i> is set. If the absolute value is equal or greater than the deadband range, PID's deadband mode is deactivated.	0.0
	0.0...200000.0	Range	1 = 1
71.40	<i>Deadband delay</i>	Defines the deadband delay for the deadband function. See parameter <i>71.39 Deadband range</i> .	0.0 s
	0.0...3600.0 s	Delay	1 = 1 s
71.58	<i>Increase prevention</i>	Activates increase prevention of PID integration term for Ext PID 1.	<i>No</i>
	No	Increase prevention not in use.	0
	Limiting	The Ext PID integration term is not increased.	1
	Process PID min lim	The Ext PID integration term is not increased when the output of the PID process has reached its minimum limit. In this setup, the external PID is used as a source for the PID process. This parameter is valid for the PID set 1.	2
	Process PID max lim	The Ext PID integration term is not increased when the output of the PID process has reached its maximum limit. In this setup, the external PID is used as a source for the PID process.	3
	<i>Other [bit]</i>	Source selection (see <i>Terms and abbreviations</i>).	-
71.59	<i>Decrease prevention</i>	Activates decrease prevention of PID integration term for Ext PID 1.	<i>No</i>
	No	Decrease prevention not in use.	0
	Limiting	The Ext PID integration term is not increased.	1
	Process PID min lim	The Ext PID integration term is not decreased when the output of the PID process has reached its minimum limit. In this setup, the external PID is used as a source for the PID process.	2
	Process PID max lim	The Ext PID integration term is not decreased when the output of the PID process has reached its maximum limit. In this setup, the external PID is used as a source for the PID process.	3
	<i>Other [bit]</i>	Source selection (see <i>Terms and abbreviations</i>).	-
71.62	<i>Internal setpoint actual</i>	See parameter <i>40.62 PID internal setpoint actual</i> .	-
71.79	<i>External PID units</i>	See parameter <i>40.79 Set 1 units</i> .	4

No.	Name/Value	Description	Default FbEq 16
<i>95 HW configuration</i>		Various hardware-related settings.	
<i>95.01</i>	<i>Supply voltage</i>	<p>Selects the supply voltage range. This parameter is used by the drive to determine the nominal voltage of the supply network. The parameter also affects the current ratings and the DC voltage control functions (trip and brake chopper activation limits) of the drive.</p> <p> WARNING! An incorrect setting may cause the motor to rush uncontrollably, or the brake chopper or resistor to overload.</p> <p>Note: The selections shown depend on the hardware of the drive. If only one voltage range is valid for the drive in question, it is selected by default.</p>	<i>Automatic / not selected</i>
	Automatic / not selected	No voltage range selected. The drive will not start modulating before a range is selected, unless parameter <i>95.02 Adaptive voltage limits</i> is set to <i>Enable</i> , in which case the drive estimates the supply voltage itself.	0
	208...240 V	208...240 V, available for ACS180-04-xxxx-1/-2 drives	1
	380...415 V	380...415 V, available for ACS180-04-xxxx-4 drives	2
	440...480 V	440...480 V, available for ACS180-04-xxxx-4 drives	3
<i>95.02</i>	<i>Adaptive voltage limits</i>	<p>Enables adaptive voltage limits.</p> <p>Adaptive voltage limits can be used if, for example, an IGBT supply unit is used to raise the DC voltage level. If the communication between the inverter and IGBT supply unit is active, the voltage limits are related to the DC voltage reference from the IGBT supply unit. Otherwise the limits are calculated based on the measured DC voltage at the end of the pre-charging sequence.</p> <p>This function is also useful if the AC supply voltage to the drive is high, as the warning levels are raised accordingly.</p>	<i>Enable</i>
	Disable	Adaptive voltage limits disabled.	0
	Enable	Adaptive voltage limits enabled.	1
<i>95.03</i>	<i>Estimated AC supply voltage</i>	<p>AC supply voltage estimated by calculation.</p> <p>Estimation is done every time the drive is powered up and is based on the rise speed of voltage level of the DC bus while the drive charges the DC bus.</p>	-
	0.0...65535.0 V	Voltage.	10 = 1 V

294 Parameters

No.	Name/Value	Description	Default FbEq 16															
95.20	<i>HW options word 1</i>	Specifies hardware-related options that require differentiated parameter defaults. This parameter is not affected by a parameter restore.	-															
		<table border="1"> <thead> <tr> <th>Bit</th> <th>Name</th> <th>Value</th> </tr> </thead> <tbody> <tr> <td>0</td> <td>Supply frequency 60 Hz</td> <td>If you change the value of this bit, you have to do a complete reset to the drive after the change. After reset you have to reselect the macro to be used. See section <i>Differences in the default values between 50 Hz and 60 Hz supply frequency settings</i> on page 318. 0 = 50 Hz. 1 = 60 Hz.</td> </tr> <tr> <td>1...12</td> <td>Reserved</td> <td></td> </tr> <tr> <td>13</td> <td>du/dt filter activation</td> <td>When active, an external du/dt filter is connected to the drive/inverter output. The setting will limit the output switching frequency, and force the fan of the drive/inverter module to full speed. 0 = du/dt filter inactive. 1 = du/dt filter active.</td> </tr> <tr> <td>14...15</td> <td>Reserved</td> <td></td> </tr> </tbody> </table>	Bit	Name	Value	0	Supply frequency 60 Hz	If you change the value of this bit, you have to do a complete reset to the drive after the change. After reset you have to reselect the macro to be used. See section <i>Differences in the default values between 50 Hz and 60 Hz supply frequency settings</i> on page 318. 0 = 50 Hz. 1 = 60 Hz.	1...12	Reserved		13	du/dt filter activation	When active, an external du/dt filter is connected to the drive/inverter output. The setting will limit the output switching frequency, and force the fan of the drive/inverter module to full speed. 0 = du/dt filter inactive. 1 = du/dt filter active.	14...15	Reserved		
Bit	Name	Value																
0	Supply frequency 60 Hz	If you change the value of this bit, you have to do a complete reset to the drive after the change. After reset you have to reselect the macro to be used. See section <i>Differences in the default values between 50 Hz and 60 Hz supply frequency settings</i> on page 318. 0 = 50 Hz. 1 = 60 Hz.																
1...12	Reserved																	
13	du/dt filter activation	When active, an external du/dt filter is connected to the drive/inverter output. The setting will limit the output switching frequency, and force the fan of the drive/inverter module to full speed. 0 = du/dt filter inactive. 1 = du/dt filter active.																
14...15	Reserved																	
	0000h...FFFFh	Hardware options configuration word.	1 = 1															
95.26	<i>Motor disconnect detection</i>	Enables the use of the motor disconnect switch, or selects the source for the enable signal. When enabled, the drive does not trip to a fault when it detects the disconnection but remains operational and returns to normal operation after a reconnection. When this parameter is enabled, the drive will go through the following sequence: <ol style="list-style-type: none"> 1. Motor is disconnected: Drive detects the disconnection and indicates it with warning <i>A784</i>. The drive remains in operation and waits for motor reconnection. 2. Motor is reconnected: Drive detects the reconnection, removes the warning and returns to normal operation. The last active reference before the disconnection is in use. Note: This feature is only available in scalar mode. This parameter does not affect vector mode behavior.	<i>Disable</i>															
	0	Disable.	1 = 1															
	1	Enable.	1 = 1															
95.200	<i>Cooling fan mode</i>	Change the cooling fan control mode	<i>Auto</i>															
	Auto	Cooling fan is controlled automatically	0															
	Always on	Cooling fan is always running	1															

No.	Name/Value	Description	Default FbEq 16
<i>96 System</i>		Language selection; access levels; macro selection; parameter save and restore; control unit reboot; user parameter sets; unit selection; parameter checksum calculation; user lock.	
96.01	<i>Language</i>	<p>Selects the language of the parameter interface and other displayed information when viewed on the control panel.</p> <p>Notes:</p> <ul style="list-style-type: none"> • Not all languages listed below are necessarily supported. • This parameter does not affect the languages visible in the Drive composer PC tool. (Those are specified under View – Settings – Drive default language.) 	<i>Not selected</i>
	Not selected	Select a language.	0
	English	English.	1033
	Deutsch	German.	1031
	Italiano	Italian.	1040
	Español	Spanish.	3082
	Portugues	Portuguese.	2070
	Nederlands	Dutch.	1043
	Français	French.	1036
	Suomi	Finnish.	1035
	Svenska	Swedish.	1053
	Russki	Russian.	1049
	Polski	Polish.	1045
	Türkçe	Turkish.	1055
	Chinese (Simplified, PRC)	Simplified Chinese.	2052
96.02	<i>Pass code</i>	<p>Pass codes can be entered into this parameter to activate further access levels, for example additional parameters, parameter lock, etc. See parameter <i>96.03 Access levels status</i>.</p> <p>Entering “358” toggles the parameter lock, which prevents the changing of all other parameters through the control panel or the Drive composer PC tool.</p> <p>Entering the user pass code (by default, “10000000”) enables parameters <i>96.100...96.102</i>, which can be used to define a new user pass code and to select the actions that are to be prevented.</p> <p>Entering an invalid pass code will close the user lock if open, ie. hide parameters <i>96.100...96.102</i>. After entering the code, check that the parameters are in fact hidden.</p> <p>Note: We recommend that you change the default user pass code. See also section <i>User lock</i> (page 105).</p>	0
	0...9999999	Pass code.	-

No.	Name/Value	Description	Default FbEq 16																						
96.03	<i>Access levels status</i>	Shows which access levels have been activated by pass codes entered into parameter <i>96.02 Pass code</i> .	0b0000																						
	<table border="1"> <thead> <tr> <th>Bit</th> <th>Name</th> </tr> </thead> <tbody> <tr><td>0</td><td>End user</td></tr> <tr><td>1</td><td>Service</td></tr> <tr><td>2, 3</td><td>Reserved</td></tr> <tr><td>4</td><td>Long menu</td></tr> <tr><td>5...10</td><td>Reserved</td></tr> <tr><td>11</td><td>OEM access level 1</td></tr> <tr><td>12</td><td>OEM access level 2</td></tr> <tr><td>13</td><td>OEM access level 3</td></tr> <tr><td>14</td><td>Parameter lock</td></tr> <tr><td>15</td><td>Reserved</td></tr> </tbody> </table>	Bit	Name	0	End user	1	Service	2, 3	Reserved	4	Long menu	5...10	Reserved	11	OEM access level 1	12	OEM access level 2	13	OEM access level 3	14	Parameter lock	15	Reserved		
Bit	Name																								
0	End user																								
1	Service																								
2, 3	Reserved																								
4	Long menu																								
5...10	Reserved																								
11	OEM access level 1																								
12	OEM access level 2																								
13	OEM access level 3																								
14	Parameter lock																								
15	Reserved																								
	0b0000...0b1111	Active access levels.	-																						
96.04	<i>Macro select</i>	<p>Selects the control macro. See chapter <i>Control macros</i> for more information.</p> <p>After a selection is made, the parameter reverts automatically to <i>Done</i>.</p> <p>Note: When you change the default parameter values of a macro, the new settings become valid immediately and stay valid even if the power of the drive is switched off and on. However, backup of the default parameter settings (factory settings) of each standard macro is still available.</p>	<i>Done</i>																						
	Done	Macro selection complete; normal operation.	0																						
	ABB standard	<i>ABB standard macro</i> . For scalar motor control.	1																						
	Hand/Auto	<i>Hand/Auto macro</i>	2																						
	Hand/PID	<i>Hand/PID macro</i>	3																						
	Modbus RTU	<i>Modbus RTU macro</i>	5																						
	3-wire	<i>3-wire macro</i>	11																						
	Alternate	<i>Alternate macro</i>	12																						
	Motor potentiometer	<i>Motor potentiometer macro</i>	13																						
	PID	<i>PID macro</i>	14																						
96.05	<i>Macro active</i>	<p>Shows which control macro is currently selected. See chapter <i>Control macros</i> for more information.</p> <p>To change the macro, use parameter <i>96.04 Macro select</i>.</p>	<i>ABB standard</i>																						
	Done	Macro selection complete; normal operation.	0																						
	ABB standard	<i>ABB standard macro</i> . For scalar motor control.	1																						
	Hand/Auto	<i>Hand/Auto macro</i>	5																						
	Hand/PID	<i>Hand/PID macro</i>	8																						
	Modbus RTU	<i>Modbus RTU macro</i>	9																						
	3-wire	<i>3-wire macro</i>	11																						
	Alternate	<i>Alternate macro</i>	12																						

No.	Name/Value	Description	Default FbEq 16
	Motor potentiometer	<i>Motor potentiometer macro</i>	13
	PID	<i>PID macro</i>	14
96.06	<i>Parameter restore</i>	Restores the original settings of the control program, ie. parameter default values. Note: This parameter cannot be changed while the drive is running.	<i>Done</i>
	Done	Restoring is completed.	0
	Restore defaults	All editable parameter values are restored to default values, except <ul style="list-style-type: none"> • motor data and ID run results • end user texts, such as customized warnings and faults (external faults and changed), and the drive name • control panel/PC communication settings • fieldbus adapter settings • control macro selection and the parameter defaults implemented by it • parameter <i>95.20 HW options word 1</i> and the differentiated defaults implemented by it. • user lock configuration parameters <i>96.100...96.102</i>. 	8
	Clear all	All editable parameter values are restored to default values, except <ul style="list-style-type: none"> • end user texts, such as customized warnings and faults (external faults and changed), and the drive name • control panel/PC communication settings • fieldbus adapter settings (clears entire existing settings) • control macro selection and the parameter defaults implemented by it • parameter <i>95.20 HW options word 1</i> and the differentiated defaults implemented by it. • user lock configuration parameters <i>96.100...96.102</i>. PC tool communication is interrupted during the restoring.	62
	Reset all fieldbus settings	Restores all fieldbus and communication related settings to default values. Note: Fieldbus, control panel and PC tool communication are interrupted during the restore.	32
	Reset home view	Restores the Home view layout to show the values of the default parameters defined by the control macro use.	512
	Reset end user texts	Restores all end user texts to default values, including the drive name, contact info, customized fault and warning texts and currency unit. If the value of parameter <i>40.79</i> is set to <i>User Text</i> , then the PID unit is also reset. If parameter <i>40.79</i> has some other value, the PID unit cannot be reset.	1024
	Reset motor data	Restores all motor nominal values and motor ID run results to default values.	2

298 Parameters

No.	Name/Value	Description	Default FbEq 16
	All to factory defaults	Restores settings and all editable parameters back to initial factory values, except the differentiated defaults implemented by parameter 95.20.	34560
96.07	<i>Parameter save manually</i>	Saves the valid parameter values to the permanent memory on the drive control board to ensure that operation can continue after cycling the power. Use this parameter to store values sent from the fieldbus. Note: A new parameter value is saved automatically when changed from the PC tool or control panel but not when altered through a fieldbus adapter connection.	<i>Done</i>
	Done	Save completed.	0
	Save	Save in progress.	1
96.08	<i>Control board boot</i>	Changing the value of this parameter to 1 reboots the control unit (without requiring a power off/on cycle of the complete drive module). The value reverts to 0 automatically.	0
	0	No action	1 = 1
	1	Reboot the control unit.	
96.10	<i>User set status</i>	Shows the status of the user parameter sets. This parameter is read-only. See also section <i>User parameter sets</i> (page 102).	-
	n/a	No user parameter sets have been saved.	0
	Loading	A user set is being loaded.	1
	Saving	A user set is being saved.	2
	Faulted	Invalid or empty parameter set.	3
	User1 IO active	User set 1 has been selected by parameters 96.12 <i>User set I/O mode in1</i> and 96.13 <i>User set I/O mode in2</i> .	4
	User2 IO active	User set 2 has been selected by parameters 96.12 <i>User set I/O mode in1</i> and 96.13 <i>User set I/O mode in2</i> .	5
	User3 IO active	User set 3 has been selected by parameters 96.12 <i>User set I/O mode in1</i> and 96.13 <i>User set I/O mode in2</i> .	6
	User4 IO active	User set 4 has been selected by parameters 96.12 <i>User set I/O mode in1</i> and 96.13 <i>User set I/O mode in2</i> .	7
	User1 backup	User set 1 has been saved or loaded.	20
	User2 backup	User set 2 has been saved or loaded.	21
	User3 backup	User set 3 has been saved or loaded.	22
	User4 backup	User set 4 has been saved or loaded.	23

No.	Name/Value	Description	Default FbEq 16															
96.11	<i>User set save/load</i>	Enables the saving and restoring of up to four custom sets of parameter settings. The set that was in use before powering down the drive is in use after the next power-up. Notes: <ul style="list-style-type: none"> Some hardware configuration settings, such as fieldbus and encoder configuration parameters (groups 14...16, 47, 50...58 and 92...93) are not included in user parameter sets. Parameter changes made after loading a set are not automatically stored – they must be saved using this parameter. This parameter cannot be changed while the drive is running 	<i>No action</i>															
	No action	Load or save operation complete; normal operation.	0															
	User set I/O mode	Load user parameter set using parameters <i>96.12 User set I/O mode in1</i> and <i>96.13 User set I/O mode in2</i> .	1															
	Load set 1	Load user parameter set 1.	2															
	Load set 2	Load user parameter set 2.	3															
	Load set 3	Load user parameter set 3.	4															
	Load set 4	Load user parameter set 4.	5															
	Save to set 1	Save user parameter set 1.	18															
	Save to set 2	Save user parameter set 2.	19															
	Save to set 3	Save user parameter set 3.	20															
	Save to set 4	Save user parameter set 4.	21															
96.12	<i>User set I/O mode in1</i>	When parameter <i>96.11 User set save/load</i> is set to <i>User set I/O mode</i> , selects the user parameter set together with parameter <i>96.13 User set I/O mode in2</i> as follows: <table border="1" data-bbox="423 954 902 1171"> <thead> <tr> <th>Status of source defined by par. <i>96.12</i></th> <th>Status of source defined by par. <i>96.13</i></th> <th>User parameter set selected</th> </tr> </thead> <tbody> <tr> <td>0</td> <td>0</td> <td>Set 1</td> </tr> <tr> <td>1</td> <td>0</td> <td>Set 2</td> </tr> <tr> <td>0</td> <td>1</td> <td>Set 3</td> </tr> <tr> <td>1</td> <td>1</td> <td>Set 4</td> </tr> </tbody> </table>	Status of source defined by par. <i>96.12</i>	Status of source defined by par. <i>96.13</i>	User parameter set selected	0	0	Set 1	1	0	Set 2	0	1	Set 3	1	1	Set 4	<i>Not selected</i>
Status of source defined by par. <i>96.12</i>	Status of source defined by par. <i>96.13</i>	User parameter set selected																
0	0	Set 1																
1	0	Set 2																
0	1	Set 3																
1	1	Set 4																
	Not selected	0.	0															
	Selected	1.	1															
	DI1	Digital input DI1 (<i>10.02 DI delayed status</i> , bit 0).	2															
	DI2	Digital input DI2 (<i>10.02 DI delayed status</i> , bit 1).	3															
	DI3	Digital input DI3 (<i>10.02 DI delayed status</i> , bit 2).	4															
	DI4	Digital input DI4 (<i>10.02 DI delayed status</i> , bit 3).	5															
	DI5	Digital input DI5 (<i>10.02 DI delayed status</i> , bit 4).	6															
	Supervision 1	Bit 0 of <i>32.01 Supervision status</i> .	24															
	Supervision 2	Bit 1 of <i>32.01 Supervision status</i> .	25															

No.	Name/Value	Description	Default FbEq 16																					
	Supervision 3	Bit 2 of <i>32.01 Supervision status</i> .	26																					
	Supervision 4	Bit 3 of <i>32.01 Supervision status</i>	27																					
	Supervision 5	Bit 4 of <i>32.01 Supervision status</i> .	28																					
	Supervision 6	Bit 5 of <i>32.01 Supervision status</i> .	29																					
	<i>Other [bit]</i>	Source selection (see <i>Terms and abbreviations</i>).	-																					
96.13	<i>User set I/O mode in2</i>	See parameter <i>96.12 User set I/O mode in1</i> .	<i>Not selected</i>																					
96.16	<i>Unit selection</i>	Selects the unit of parameters indicating power, temperature and torque.	0b0000																					
		<table border="1"> <thead> <tr> <th>Bit</th> <th>Name</th> <th>Information</th> </tr> </thead> <tbody> <tr> <td>0</td> <td>Power unit (mechanical)</td> <td>0 = kW 1 = hp</td> </tr> <tr> <td>1</td> <td>Reserved</td> <td></td> </tr> <tr> <td>2</td> <td>Temperature unit</td> <td>0 = °C 1 = °F</td> </tr> <tr> <td>3</td> <td>Reserved</td> <td></td> </tr> <tr> <td>4</td> <td>Torque unit</td> <td>0 = Nm (N·m) 1 = lbft (lb·ft)</td> </tr> <tr> <td>5...15</td> <td>Reserved</td> <td></td> </tr> </tbody> </table>	Bit	Name	Information	0	Power unit (mechanical)	0 = kW 1 = hp	1	Reserved		2	Temperature unit	0 = °C 1 = °F	3	Reserved		4	Torque unit	0 = Nm (N·m) 1 = lbft (lb·ft)	5...15	Reserved		
Bit	Name	Information																						
0	Power unit (mechanical)	0 = kW 1 = hp																						
1	Reserved																							
2	Temperature unit	0 = °C 1 = °F																						
3	Reserved																							
4	Torque unit	0 = Nm (N·m) 1 = lbft (lb·ft)																						
5...15	Reserved																							
	0b0000...0b1111	Unit selection word.	1 = 1																					
96.51	<i>Clear fault and event logger</i>	Clears all events from the drive's fault and event logs.	<i>Done</i>																					
	Done	0 = No action.	0																					
	Reset	1 = Resets (clears) fault and event logger.	1																					
96.54	<i>Checksum action</i>	Selects how the drive reacts <ul style="list-style-type: none"> when <i>96.55 Checksum control word, bit 8 = 1 (Approved checksum A)</i>: if the parameter checksum <i>96.68 Actual checksum A</i> does not match <i>96.71 Approved checksum A</i>, and/or when <i>96.55 Checksum control word, bit 9 = 1 (Approved checksum B)</i>: if the parameter checksum <i>96.69 Actual checksum B</i> does not match <i>96.72 Approved checksum B</i>. 	<i>No action</i>																					
	No action	No action taken. (The checksum feature is not in use.)	0																					
	Pure event	The drive generates an event log entry (<i>B686 Checksum mismatch</i>).	1																					
	Warning	The drive generates a warning (<i>A686 Checksum mismatch</i>).	2																					
	Warning and prevent start	The drive generates a warning (<i>A686 Checksum mismatch</i>). Starting the drive is prevented.	3																					
	Fault	The drive trips on <i>6200 Checksum mismatch</i> .	4																					

No.	Name/Value	Description	Default FbEq 16																								
96.55	<i>Checksum control word</i>	<p>Bits 8...9 select which comparison(s) are made:</p> <ul style="list-style-type: none"> • Bit 8 = 1 (Approved checksum A): 96.68 Actual checksum A is compared to 96.71 Approved checksum A, and/or • Bit 9 = 1 (Approved checksum A): if 96.69 Actual checksum B is compared to 96.72 Approved checksum B. <p>Bits 12...13 select approved (reference) checksum parameter(s) into which the actual checksum(s) from parameter(s) are copied:</p> <ul style="list-style-type: none"> • Bit 12 = 1 (Set approved checksum A): Value of 96.68 Actual checksum A is copied into 96.71 Approved checksum A and/or • Bit 13 = 1 (Set approved checksum B): Value of 96.69 Actual checksum B copied into 96.72 Approved checksum B. 	0b0000																								
<table border="1"> <thead> <tr> <th>Bit</th> <th>Name</th> <th>Information</th> </tr> </thead> <tbody> <tr> <td>0...7</td> <td>Reserved</td> <td></td> </tr> <tr> <td>8</td> <td>Approved checksum A</td> <td>1 = Enabled: Checksum A (96.71) is observed. 0 = Disabled.</td> </tr> <tr> <td>9</td> <td>Approved checksum B</td> <td>1 = Enabled: Checksum B (96.72) is observed. 0 = Disabled.</td> </tr> <tr> <td>10...11</td> <td>Reserved</td> <td></td> </tr> <tr> <td>12</td> <td>Set approved checksum A</td> <td>1 = Set: Copy value of 96.68 into 96.71. 0 = Done (copy has been made).</td> </tr> <tr> <td>13</td> <td>Set approved checksum B</td> <td>1 = Set: Copy value of 96.69 into 96.72. 0 = Done (copy has been made).</td> </tr> <tr> <td>14...15</td> <td>Reserved</td> <td></td> </tr> </tbody> </table>				Bit	Name	Information	0...7	Reserved		8	Approved checksum A	1 = Enabled: Checksum A (96.71) is observed. 0 = Disabled.	9	Approved checksum B	1 = Enabled: Checksum B (96.72) is observed. 0 = Disabled.	10...11	Reserved		12	Set approved checksum A	1 = Set: Copy value of 96.68 into 96.71. 0 = Done (copy has been made).	13	Set approved checksum B	1 = Set: Copy value of 96.69 into 96.72. 0 = Done (copy has been made).	14...15	Reserved	
Bit	Name	Information																									
0...7	Reserved																										
8	Approved checksum A	1 = Enabled: Checksum A (96.71) is observed. 0 = Disabled.																									
9	Approved checksum B	1 = Enabled: Checksum B (96.72) is observed. 0 = Disabled.																									
10...11	Reserved																										
12	Set approved checksum A	1 = Set: Copy value of 96.68 into 96.71. 0 = Done (copy has been made).																									
13	Set approved checksum B	1 = Set: Copy value of 96.69 into 96.72. 0 = Done (copy has been made).																									
14...15	Reserved																										
0b0000...0b1111		Checksum control word.	1 = 1																								
96.68	<i>Actual checksum A</i>	<p>Displays the actual parameter configuration checksum A. The checksum A is generated and updated whenever an action is selected in 96.54 Checksum action and 96.55 Checksum control word, bit 8 = 1 (Approved checksum A)</p> <p>The set of parameters for checksum A calculation does not include fieldbus settings parameters.</p> <p>The parameters included in the checksum A calculation are user editable parameters in parameter groups 10, 15, 19, 20, 21, 22, 23, 24, 25, 28, 30, 31, 32, 35, 36, 37, 40, 41, 45, 46, 71, 95, 96, 97, 98, and 99.</p> <p>See also section <i>Parameter checksum calculation</i> (page 103).</p>	0x0000																								
0x0000...0xffff		Actual checksum A.	1 = 1																								

302 Parameters

No.	Name/Value	Description	Default FbEq 16
96.69	<i>Actual checksum B</i>	Displays the actual parameter configuration checksum B. The checksum B is generated and updated whenever an action is selected in <i>96.54 Checksum action</i> and <i>96.55 Checksum control word</i> , bit 9 = 1 (Approved checksum B) The set of parameters for checksum B does not include: <ul style="list-style-type: none"> • fieldbus settings • motor data settings, and • energy data settings parameters. The parameters included in the checksum B calculation are user editable parameters in parameter groups 10, 15, 19, 20, 21, 22, 23, 24, 25, 28, 30, 31, 32, 35, 36, 37, 40, 41, 46, 71, 95, 96, and 97. See also section <i>Parameter checksum calculation</i> (page 103).	0x0000
	0x0000...0xffff	Actual checksum B.	1 = 1
96.70	<i>Disable adaptive program</i>	Selects if the adaptive program is enabled or disabled	
	No	Adaptive program is enabled. Adaptive program is set to running mode automatically when drive is powered on. Commanding adaptive program to running mode is possible from PC tool.	0
	Yes	Adaptive program is disabled. Setting adaptive program to running mode is not possible. If adaptive program was running when disabled, then adaptive program is stopped and set to init state.	1
96.71	<i>Approved checksum A</i>	Approved (reference) checksum A.	0x0000
	0x0000...0xffff	Approved checksum A.	-
96.72	<i>Approved checksum B</i>	Approved (reference) checksum B.	0x0000
	0x0000...0xffff	Approved checksum B.	-
96.78	<i>Legacy Modbus mapping</i>	Enables/disables the drive's Modbus register mapping to match that of the ACx310/320/355. See the supported parameters in section <i>Parameters supported by Modbus backwards compatibility with legacy drives</i> on page 319.	<i>Disabled</i>
	Disable	Legacy Modbus register mapping mode is disabled.	0
	Enable	Legacy Modbus register mapping mode is enabled.	1
96.79	<i>Legacy control profile</i>	Enables using a legacy control profile. Currently only EFB supports legacy profiles.	<i>Not selected</i>
	Not selected	EFB: Control profile selected with <i>58.25 Control profile</i> used.	0
	DCU	Legacy DCU profile used.	1
	ABB drives	ABB drives profile used.	2
	ABB drives limited	Legacy ABB drives limited profile used.	3

No.	Name/Value	Description	Default FbEq 16																																	
96.100	<i>Change user pass code</i>	<i>(Visible when user lock is open)</i> To change the current user pass code, enter a new code into this parameter as well as <i>96.101 Confirm user pass code</i> . A warning <i>A6B1</i> will be active until the new pass code is confirmed. To cancel changing the pass code, close the user lock without confirming. To close the lock, enter an invalid pass code in parameter <i>96.02 Pass code</i> , activate parameter <i>96.08 Control board boot</i> , or cycle the power. See also section <i>User lock</i> (page 105).	10000000																																	
	10000000... 99999999	New user pass code.	-																																	
96.101	<i>Confirm user pass code</i>	<i>(Visible when user lock is open)</i> Confirms the new user pass code entered in <i>96.100 Change user pass code</i> .																																		
	10000000... 99999999	Confirmation of new user pass code.	-																																	
96.102	<i>User lock functionality</i>	<i>(Visible when user lock is open)</i> Selects the actions or functionalities to be prevented by the user lock. Note that the changes made take effect only when the user lock is closed. See parameter <i>96.02 Pass code</i> .	0000h																																	
		<table border="1"> <thead> <tr> <th>Bit</th> <th>Name</th> <th>Information</th> </tr> </thead> <tbody> <tr> <td>0</td> <td>Disable ABB access levels</td> <td>1 = ABB access levels (service, advanced programmer, etc.; see <i>96.03</i>) disabled</td> </tr> <tr> <td>1</td> <td>Freeze parameter lock state</td> <td>1 = Changing the parameter lock state prevented, ie. pass code 358 has no effect</td> </tr> <tr> <td>2</td> <td>Disable file download</td> <td>1 = Loading of files to drive prevented. This applies to <ul style="list-style-type: none"> • firmware upgrades • parameter restore • loading of adaptive or application programs • changing home view of control panel • editing drive texts • editing the favorite parameters list on control panel • configuration settings made through control panel such as time/date formats and enabling/disabling clock display. </td> </tr> <tr> <td>3</td> <td>Disable FB write to hidden</td> <td>1 = Disable fieldbus write to closed access level.</td> </tr> <tr> <td>4</td> <td>Disable backups</td> <td>1 = Disable backup file download.</td> </tr> <tr> <td>5...10</td> <td>Reserved</td> <td></td> </tr> <tr> <td>11</td> <td>Disable OEM access level 1</td> <td>1 = Disable OEM access level 1.</td> </tr> <tr> <td>12</td> <td>Disable OEM access level 2</td> <td>1 = Disable OEM access level 2.</td> </tr> <tr> <td>13</td> <td>Disable OEM access level 3</td> <td>1 = Disable OEM access level 3.</td> </tr> <tr> <td>14, 15</td> <td>Reserved</td> <td></td> </tr> </tbody> </table>	Bit	Name	Information	0	Disable ABB access levels	1 = ABB access levels (service, advanced programmer, etc.; see <i>96.03</i>) disabled	1	Freeze parameter lock state	1 = Changing the parameter lock state prevented, ie. pass code 358 has no effect	2	Disable file download	1 = Loading of files to drive prevented. This applies to <ul style="list-style-type: none"> • firmware upgrades • parameter restore • loading of adaptive or application programs • changing home view of control panel • editing drive texts • editing the favorite parameters list on control panel • configuration settings made through control panel such as time/date formats and enabling/disabling clock display. 	3	Disable FB write to hidden	1 = Disable fieldbus write to closed access level.	4	Disable backups	1 = Disable backup file download.	5...10	Reserved		11	Disable OEM access level 1	1 = Disable OEM access level 1.	12	Disable OEM access level 2	1 = Disable OEM access level 2.	13	Disable OEM access level 3	1 = Disable OEM access level 3.	14, 15	Reserved		
Bit	Name	Information																																		
0	Disable ABB access levels	1 = ABB access levels (service, advanced programmer, etc.; see <i>96.03</i>) disabled																																		
1	Freeze parameter lock state	1 = Changing the parameter lock state prevented, ie. pass code 358 has no effect																																		
2	Disable file download	1 = Loading of files to drive prevented. This applies to <ul style="list-style-type: none"> • firmware upgrades • parameter restore • loading of adaptive or application programs • changing home view of control panel • editing drive texts • editing the favorite parameters list on control panel • configuration settings made through control panel such as time/date formats and enabling/disabling clock display. 																																		
3	Disable FB write to hidden	1 = Disable fieldbus write to closed access level.																																		
4	Disable backups	1 = Disable backup file download.																																		
5...10	Reserved																																			
11	Disable OEM access level 1	1 = Disable OEM access level 1.																																		
12	Disable OEM access level 2	1 = Disable OEM access level 2.																																		
13	Disable OEM access level 3	1 = Disable OEM access level 3.																																		
14, 15	Reserved																																			
	0000h...FFFFh	Selection of actions to be prevented by user lock.	-																																	



304 Parameters

No.	Name/Value	Description	Default FbEq 16
<i>97 Motor control</i>		Switching frequency; slip gain; voltage reserve; flux braking; anti-cogging (signal injection); IR compensation.	
97.01	<i>Switching frequency reference</i>	Defines the switching frequency of the drive that is used as long as the drive does not heat too much. See section <i>Switching frequency</i> on page 73. Higher switching frequency results in lower acoustic noise. In multimotor systems, do not change the switching frequency from the default value.	4 kHz
	4 kHz	4 kHz.	4
	8 kHz	8 kHz.	8
	12 kHz	12 kHz.	12
97.02	<i>Minimum switching frequency</i>	Lowest switching frequency that is allowed. Depends on the frame size.	1.5 kHz
	1.5 kHz	1.5 kHz. In some larger frame sizes 1 kHz is used instead.	1.5
	2 kHz	2 kHz.	2
	4 kHz	4 kHz.	4
	8 kHz	8 kHz.	8
	12 kHz	12 kHz.	12
97.03	<i>Slip gain</i>	Defines the slip gain which is used to improve the estimated motor slip. 100% means full slip gain; 0% means no slip gain. The default value is 100%. Other values can be used if a static speed error is detected despite having the setting at full slip gain. Example (with nominal load and nominal slip of 40 rpm): A 1000 rpm constant speed reference is given to the drive. Despite having full slip gain (= 100%), a manual tachometer measurement from the motor axis gives a speed value of 998 rpm. The static speed error is 1000 rpm - 998 rpm = 2 rpm. To compensate the error, the slip gain should be increased to 105% (2 rpm / 40 rpm = 5%).	100%
	0...200%	Slip gain.	1 = 1%

No.	Name/Value	Description	Default FbEq 16
97.04	<i>Voltage reserve</i>	Defines the minimum allowed voltage reserve. When the voltage reserve has decreased to the set value, the drive enters the field weakening area. Note: This is an expert level parameter and should not be adjusted without appropriate skill. If the intermediate circuit DC voltage $U_{dc} = 550$ V and the voltage reserve is 5%, the RMS value of the maximum output voltage in steady-state operation is $0.95 \times 550 \text{ V} / \sqrt{2} = 369$ V The dynamic performance of the motor control in the field weakening area can be improved by increasing the voltage reserve value, but the drive enters the field weakening area earlier.	-2%
	-5...50%	Voltage reserve. Setting voltage reserve to -5...-4% will enable full output voltage (motor voltage = network voltage at rated frequency). This will increase the current harmonics to the motor and might lead to motor heating.	1 = 1%
97.05	<i>Flux braking</i>	Defines the level of flux braking power. (Other stopping and braking modes can be configured in parameter group 21 <i>Start/stop mode</i>). Note: This is an expert level parameter and should not be adjusted without appropriate skill.	<i>Disabled</i>
	Disabled	Flux braking is disabled.	0
	Moderate	Flux level is limited during the braking. Deceleration time is longer compared to full braking.	1
	Full	Maximum braking power. Almost all available current is used to convert the mechanical braking energy to thermal energy in the motor.  WARNING! Using full flux braking heats up the motor especially in cyclic operation. Make sure that the motor can withstand this if you have a cyclic application.	2
97.06	<i>Flux reference select</i>	Defines the source of flux reference. Notes: <ul style="list-style-type: none"> This is an expert level parameter and should not be adjusted without appropriate skill. Do not use this parameter in scalar control mode, if the parameter 97.20 <i>U/f ratio</i> is set to <i>Squared</i>. 	<i>User flux reference</i>
	Zero	Minimum value of parameter 97.07 <i>User flux reference</i> .	0
	User flux reference	Parameter 97.07 <i>User flux reference</i> .	1
	<i>Other</i>	Source selection (see <i>Terms and abbreviations</i>).	-
97.07	<i>User flux reference</i>	Defines the flux reference when parameter 97.06 <i>Flux reference select</i> is set to <i>User flux reference</i> . Note: <ul style="list-style-type: none"> ABB recommends the range of 20.00%...120.00%. 	100.00%
	0.00...200.00%	User-defined flux reference.	100 = 1%

306 Parameters

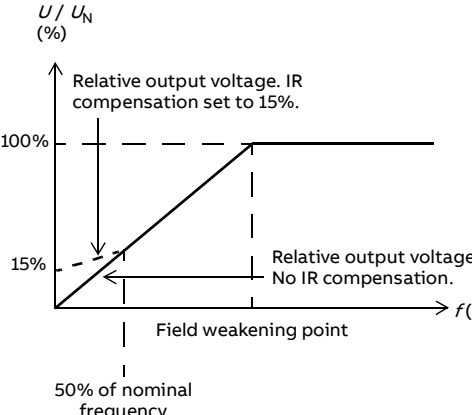
No.	Name/Value	Description	Default FbEq 16
97.08	<i>Optimizer minimum torque</i>	This parameter can be used to improve the control dynamics of a synchronous reluctance motor or a salient permanent magnet synchronous motor. As a rule of thumb, define a level to which the output torque must rise with minimum delay. This will increase the motor current and improve the torque response at low speeds.	0.0%
	0.0...1600.0%	Optimizer torque limit.	10 = 1%
97.11	<i>TR tuning</i>	Rotor time constant tuning. This parameter can be used to improve torque accuracy in closed-loop control of an induction motor. Normally, the motor identification run provides sufficient torque accuracy, but manual fine-tuning can be applied in exceptionally demanding applications to achieve optimal performance. Note: This is an expert level parameter and should not be adjusted without appropriate skill.	100%
	25...400%	Rotor time constant tuning.	1 = 1%

No.	Name/Value	Description	Default FbEq 16																																																																					
97.13	<i>IR compensation</i>	<p>Defines the relative output voltage boost at zero speed (IR compensation). The function is useful in applications with a high break-away torque where vector control cannot be applied.</p>  <p>See also section <i>IR compensation for scalar motor control</i> on page 56.</p> <p>Typical IR compensation values are shown below.</p> <table border="1" data-bbox="425 821 896 949"> <thead> <tr> <th colspan="9">3-phase 180...480V drives</th> </tr> </thead> <tbody> <tr> <td>P_N (kW)</td> <td>0, 37</td> <td>0, 75</td> <td>1, 1</td> <td>2, 2</td> <td>4</td> <td>7, 5</td> <td>15</td> <td>22</td> </tr> <tr> <td>IR compensation (%)</td> <td>3, 5</td> <td>3, 5</td> <td>3, 2</td> <td>2, 5</td> <td>2</td> <td>1, 5</td> <td>1, 25</td> <td>1, 2</td> </tr> </tbody> </table> <table border="1" data-bbox="425 957 896 1077"> <thead> <tr> <th colspan="8">3-phase 200...240V drives</th> </tr> </thead> <tbody> <tr> <td>P_N (kW)</td> <td>0, 37</td> <td>0, 75</td> <td>1, 1</td> <td>2, 2</td> <td>3</td> <td>7, 5</td> <td>11</td> </tr> <tr> <td>IR compensation (%)</td> <td>3, 5</td> <td>3, 5</td> <td>2, 6</td> <td>2, 4</td> <td>2, 2</td> <td>1, 7</td> <td>1, 5</td> </tr> </tbody> </table> <table border="1" data-bbox="425 1085 896 1212"> <thead> <tr> <th colspan="6">1-phase 200...240V drives</th> </tr> </thead> <tbody> <tr> <td>P_N (kW)</td> <td>0, 37</td> <td>0, 75</td> <td>1, 1</td> <td>1, 5</td> <td>2, 2</td> </tr> <tr> <td>IR compensation (%)</td> <td>3, 0</td> <td>2, 3</td> <td>2, 0</td> <td>1, 7</td> <td>1, 5</td> </tr> </tbody> </table> <p> WARNING! Set IR compensation value as low as possible. Large IR compensation value can lead to overheating of the motor and damage to the drive, if operated for longer periods at low speed.</p>	3-phase 180...480V drives									P _N (kW)	0, 37	0, 75	1, 1	2, 2	4	7, 5	15	22	IR compensation (%)	3, 5	3, 5	3, 2	2, 5	2	1, 5	1, 25	1, 2	3-phase 200...240V drives								P _N (kW)	0, 37	0, 75	1, 1	2, 2	3	7, 5	11	IR compensation (%)	3, 5	3, 5	2, 6	2, 4	2, 2	1, 7	1, 5	1-phase 200...240V drives						P _N (kW)	0, 37	0, 75	1, 1	1, 5	2, 2	IR compensation (%)	3, 0	2, 3	2, 0	1, 7	1, 5	3.20%
3-phase 180...480V drives																																																																								
P _N (kW)	0, 37	0, 75	1, 1	2, 2	4	7, 5	15	22																																																																
IR compensation (%)	3, 5	3, 5	3, 2	2, 5	2	1, 5	1, 25	1, 2																																																																
3-phase 200...240V drives																																																																								
P _N (kW)	0, 37	0, 75	1, 1	2, 2	3	7, 5	11																																																																	
IR compensation (%)	3, 5	3, 5	2, 6	2, 4	2, 2	1, 7	1, 5																																																																	
1-phase 200...240V drives																																																																								
P _N (kW)	0, 37	0, 75	1, 1	1, 5	2, 2																																																																			
IR compensation (%)	3, 0	2, 3	2, 0	1, 7	1, 5																																																																			
	0.00...50.00%	Voltage boost at zero speed in percent of nominal motor voltage.	1 = 1%																																																																					

308 Parameters

No.	Name/Value	Description	Default FbEq 16
97.15	<i>Motor model temperature adaptation</i>	Selects whether the temperature-dependent parameters (such as stator or rotor resistance) of the motor model adapt to actual (measured or estimated) temperature or not. See parameter group <i>35 Motor thermal protection</i> for selection of temperature measurement sources.	<i>Disabled</i>
	Disabled	Temperature adaptation of motor model disabled.	0
	Estimated temperature	Estimated temperature (<i>35.01 Motor estimated temperature</i>) used for adaptation of motor model.	1
97.16	<i>Stator temperature factor</i>	Tunes the motor temperature dependence of stator parameters (stator resistance).	50
	0...200 %	Tuning factor.	
97.17	<i>Rotor temperature factor</i>	Tunes the motor temperature dependence of rotor parameters (eg. rotor resistance).	100
	0...200 %	Tuning factor.	
97.20	<i>U/f ratio</i>	Selects the form for the <i>U/f</i> (voltage to frequency) ratio below field weakening point. For scalar control only.	<i>Disabled</i>
	Linear	Linear ratio for constant torque applications.	0
	Squared	Squared ratio for centrifugal pump and fan applications. With squared <i>U/f</i> ratio the noise level is lower for most operating frequencies. Not recommended for permanent magnet motors.	1
97.33	<i>Speed estimate filter time</i>	Defines a filtering time for estimated speed.	5.00
	0.00...100.00 ms	Filtering time for estimated speed.	1 = 1 ms
97.48	<i>Udc stabilizer</i>	Enables or disables the DC bus voltage stabilizer.	<i>Disabled</i>
	Disabled	DC bus voltage stabilizer disabled.	0
	Enabled min	DC bus voltage stabilizer enabled, minimum stabilization.	50
	Enabled mild	DC bus voltage stabilizer enabled, mild stabilization.	100
	Enabled medium	DC bus voltage stabilizer enabled, medium stabilization.	300
	Enabled strong	DC bus voltage stabilizer enabled, strong stabilization.	500
	Enabled max	DC bus voltage stabilizer enabled, maximum stabilization.	800

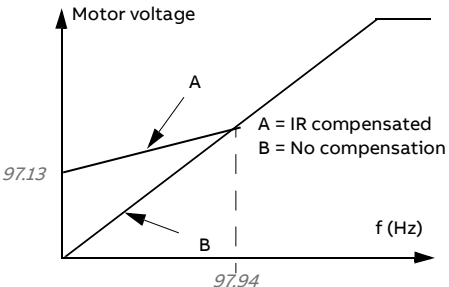
No.	Name/Value	Description	Default FbEq 16
97.49	<i>Slip gain for scalar</i>	Sets gain for slip compensation (in %) while drive is operating in scalar control mode. <ul style="list-style-type: none"> • A squirrel-cage motor slips under load. Increasing the frequency as the motor torque increases compensates for the slip. • Requires parameter <i>99.04 Motor control mode = Scalar</i>. 0 = No slip compensation. 1...200 = Increasing slip compensation. 100% means full slip compensation according to parameters <i>99.08 Motor nominal frequency</i> and <i>99.09 Motor nominal speed</i> .	0
	0...200 %	Slip compensation in %.	1 = 1%
97.94	<i>IR comp max frequency</i>	Sets the frequency at which IR compensation (set by parameter <i>97.13 IR compensation</i>) reaches 0 V. The unit is % of motor nominal frequency. IR compensation When enabled, IR compensation provides an extra voltage boost to the motor at low speeds. Use IR compensation, for example, in applications that require a high breakaway torque. <div style="text-align: center;">  </div>	50.0
	1.0...200.0 %	IR compensation maximum frequency in %.	1 = 1%
97.135	<i>Udc ripple</i>	Calculates ripple voltage.	0.0 V
	0.0...200.0 V	Voltage.	1 = 1 V

310 Parameters

No.	Name/Value	Description	Default FbEq 16
<i>98 User motor parameters</i>		Motor values supplied by the user that are used in the motor model. These parameters are useful for non-standard motors, or to just get more accurate motor control of the motor on site. A better motor model always improves the shaft performance.	
<i>98.01</i>	<i>User motor model mode</i>	Activates the motor model parameters <i>98.02...98.12</i> and <i>98.14</i> . Notes: <ul style="list-style-type: none"> Parameter value is automatically set to zero when ID run is selected by parameter <i>99.13 ID run requested</i>. The values of parameters <i>98.02...98.12</i> are then updated according to the motor characteristics identified during the ID run. Measurements made directly from the motor terminals during the ID run are likely to produce slightly different values than those on a data sheet from a motor manufacturer. This parameter cannot be changed while the drive is running. 	<i>Not selected</i>
	Not selected	Parameters <i>98.02...98.12</i> inactive.	0
	Motor parameters	The values of parameters <i>98.02...98.12</i> are used as the motor model.	1
<i>98.02</i>	<i>Rs user</i>	Defines the stator resistance R_S of the motor model. With a star-connected motor, R_S is the resistance of one winding. With a delta-connected motor, R_S is one-third of the resistance of one winding.	0.00000 p.u.
	0.00000...0.50000 p.u.	Stator resistance in per unit.	-
<i>98.03</i>	<i>Rr user</i>	Defines the rotor resistance R_R of the motor model. Note: This parameter is valid only for asynchronous motors.	0.00000 p.u.
	0.00000...0.50000 p.u.	Rotor resistance in per unit.	-
<i>98.04</i>	<i>Lm user</i>	Defines the main inductance L_M of the motor model. Note: This parameter is valid only for asynchronous motors.	0.00000 p.u.
	0.00000... 10.00000 p.u.	Main inductance in per unit.	-
<i>98.05</i>	<i>SigmaL user</i>	Defines the leakage inductance σL_S . Note: This parameter is valid only for asynchronous motors.	0.00000 p.u.
	0.00000...1.00000 p.u.	Leakage inductance in per unit.	-
<i>98.06</i>	<i>Ld user</i>	Defines the direct axis (synchronous) inductance. Note: This parameter is valid only for permanent magnet motors.	0.00000 p.u.
	0.00000 ... 10.00000 p.u	Direct axis inductance in per unit.	-

No.	Name/Value	Description	Default FbEq 16
98.07	<i>Lq user</i>	Defines the quadrature axis (synchronous) inductance. Note: This parameter is valid only for permanent magnet motors.	0.00000 p.u.
	0.00000 ... 10.00000 p.u	Quadrature axis inductance in per unit.	-
98.08	<i>PM flux user</i>	Defines the permanent magnet flux. Note: This parameter is valid only for permanent magnet motors.	0.00000 p.u.
	0.00000 ... 2.00000 p.u	Permanent magnet flux in per unit.	-
98.09	<i>Rs user SI</i>	Defines the stator resistance R_S of the motor model.	0.00000 ohm
	0.00000... 100.00000 ohm	Stator resistance.	-
98.10	<i>Rs user SI</i>	Defines the rotor resistance R_R of the motor model. Note: This parameter is valid only for asynchronous motors.	0.00000 ohm
	0.00000... 100.00000 ohm	Rotor resistance.	-
98.11	<i>Lm user SI</i>	Defines the main inductance L_M of the motor model. Note: This parameter is valid only for asynchronous motors.	0.00 mH
	0.00...100000.00 mH	Main inductance.	1 = 10000 mH
98.12	<i>SigmaL user SI</i>	Defines the leakage inductance σL_S . Note: This parameter is valid only for asynchronous motors.	0.00 mH
	0.00...100000.00 mH	Leakage inductance.	1 = 10000 mH
98.13	<i>Ld user SI</i>	Defines the direct axis (synchronous) inductance. Note: This parameter is valid only for permanent magnet motors.	0.00 mH
	0.00 ...100000.00 mH	Direct axis inductance.	1 = 10000 mH
98.14	<i>Lq user SI</i>	Defines the quadrature axis (synchronous) inductance. Note: This parameter is valid only for permanent magnet motors.	0.00 mH
	0.00 ...100000.00 mH	Quadrature axis inductance.	1 = 10000 mH
99 Motor data		Motor configuration settings.	
99.03	<i>Motor type</i>	Selects the motor type. Note: This parameter cannot be changed while the drive is running.	<i>Asynchronous motor</i>
	Asynchronous motor	Standard squirrel cage AC induction motor (asynchronous induction motor).	0



No.	Name/Value	Description	Default FbEq 16
	Permanent magnet motor	<p>Permanent magnet motor. Three-phase AC synchronous motor with permanent magnet rotor and sinusoidal BackEMF voltage.</p> <p>Note: With permanent magnet motors special attention must be paid on setting the motor nominal values correctly in this parameter group (<i>99 Motor data</i>). You must use vector control. If the nominal BackEMF voltage of the motor is not available, a full ID run should be performed for improving performance.</p>	1
99.04	<i>Motor control mode</i>	Selects the motor control mode.	<i>Scalar</i>
	Vector	<p>Vector control. Vector control has better accuracy than scalar control but cannot be used in all situations (see selection Scalar below). Requires motor identification run (ID run). See parameter <i>99.13 ID run requested</i>.</p> <p>Note: In vector control the drive performs a standstill ID run at the first start if ID run has not been previously performed. A new start command is required after standstill ID run.</p> <p>Note: To achieve a better motor control performance, you can perform a normal ID run without load. See also section <i>Operating modes of the drive</i> (page 48).</p>	0
	Scalar	<p>Scalar control. Suitable for most applications, if top performance is not required. Motor identification run is not required.</p> <p>Note: Scalar control must be used in the following situations:</p> <ul style="list-style-type: none"> • with multimotor applications 1) if the load is not equally shared between the motors, 2) if the motors are of different sizes, or 3) if the motors are going to be changed after the motor identification (ID run) • if the nominal current of the motor is less than 1/6 of the nominal output current of the drive • if the drive is used with no motor connected (for example, for test purposes). <p>Note: Correct motor operation requires that the magnetizing current of the motor does not exceed 90% of the nominal current of the inverter. See also section <i>Speed control performance figures</i> (page 67), and section <i>Operating modes of the drive</i> (page 48).</p>	1

No.	Name/Value	Description	Default FbEq 16
99.06	<i>Motor nominal current</i>	Defines the nominal motor current. Must be equal to the value on the motor rating plate. If multiple motors are connected to the drive, enter the total current of the motors. Notes: <ul style="list-style-type: none"> • Correct motor operation requires that the magnetizing current of the motor does not exceed 90% of the nominal current of the drive. • This parameter cannot be changed while the drive is running. 	4.0 A
	0.0...4.8 A	Nominal current of the motor. The allowable range: <ul style="list-style-type: none"> • vector control mode: $1/6...2 \times I_N$ of the drive • scalar control mode: $0...2 \times I_N$ of the drive. Note: When using flying start in scalar control mode (see parameter 21.19), the nominal current must be in the range allowed for vector control mode.	1 = 0.01 A (see par. 46.05)
99.07	<i>Motor nominal voltage</i>	Defines the nominal motor voltage supplied to the motor. This setting must match the value on the rating plate of the motor. Notes: <ul style="list-style-type: none"> • With permanent magnet motors, the nominal voltage is the BackEMF voltage at nominal speed of the motor. If the voltage is given as voltage per rpm, e.g. 60 V per 1000 rpm, the voltage for a nominal speed of 3000 rpm is $3 \times 60 \text{ V} = 180 \text{ V}$. Note that the nominal voltage is not equal to the equivalent DC motor voltage (EDCM) specified by some motor manufacturers. The nominal voltage can be calculated by dividing the EDCM voltage by 1.7 (or square root of 3). • The stress on the motor insulation is always dependent on the drive supply voltage. This also applies to the case where the motor voltage rating is lower than that of the drive and the supply. • This parameter cannot be changed while the drive is running. 	230.0 V
	40.0...480.0	Nominal voltage of the motor.	10 = 1 V
99.08	<i>Motor nominal frequency</i>	Defines the nominal motor frequency. This setting must match the value on the rating plate of the motor. Note: This parameter cannot be changed while the drive is running.	50.00 Hz
	0.00...500.00 Hz	Nominal frequency of the motor.	10 = 1 Hz
99.09	<i>Motor nominal speed</i>	Defines the nominal motor speed. The setting must match the value on the rating plate of the motor. Note: This parameter cannot be changed while the drive is running.	1435 rpm
	0...30000 rpm	Nominal speed of the motor.	1 = 1 rpm

314 Parameters

No.	Name/Value	Description	Default FbEq 16
99.10	<i>Motor nominal power</i>	Defines the nominal motor power. The setting must match the value on the rating plate of the motor. If multiple motors are connected to the drive, enter the total power of the motors. The unit is selected by parameter <i>96.16 Unit selection</i> . Note: This parameter cannot be changed while the drive is running.	1.10 kW or hp
	0.00... 10000.00 kW or 0.00... 13404.83 hp	Nominal power of the motor.	1 = 0.01 unit (see par. <i>46.04</i>)
99.11	<i>Motor nominal cos ϕ</i>	Defines the cosphi of the motor for a more accurate motor model. This value is not obligatory, but is useful with an asynchronous motor, especially when performing a standstill identification run. With a permanent magnet or synchronous reluctance motor, this value is not needed. Notes: <ul style="list-style-type: none"> Do not enter an estimated value. If you do not know the exact value, leave the parameter at zero. This parameter cannot be changed while the drive is running. 	0.00
	0.00...1.00	Cosphi of the motor.	100 = 1
99.12	<i>Motor nominal torque</i>	Defines the nominal motor shaft torque for a more accurate motor model. Not obligatory. The unit is selected by parameter <i>96.16 Unit selection</i> . Note: This parameter cannot be changed while the drive is running.	0.000 N-m or lb-ft
	0.000...4000000.00 0 N-m or 0.000...2950248.597 lb-ft	Nominal motor torque.	1 = 100 unit

No.	Name/Value	Description	Default FbEq 16
99.13	<i>ID run requested</i>	<p>Selects the type of the motor identification routine (ID run) performed at the next start of the drive. During the ID run, the drive will identify the characteristics of the motor for optimum motor control.</p> <p>If no ID run has been performed yet (or if default parameter values have been restored using parameter <i>96.06 Parameter restore</i>), this parameter is automatically set to <i>Standstill</i>, signifying that an ID run must be performed.</p> <p>After the ID run, the drive stops and this parameter is automatically set to <i>None</i>.</p> <p>Notes:</p> <ul style="list-style-type: none"> • To ensure that the ID run can work properly, the drive limits in group <i>30 Limits</i> (maximum speed and minimum speed, and maximum torque and minimum torque) must be large enough (the range specified by the limits must be wide enough. If eg. speed limits are less than the motor nominal speed, the ID run cannot be completed. • For the <i>Advanced</i> ID run, the machinery must always be de-coupled from the motor. • With a permanent magnet or synchronous reluctance motor, a <i>Normal</i>, <i>Reduced</i> or <i>Standstill</i> ID run requires that the motor shaft is NOT locked and the load torque is less than 10%. • Once the ID run is activated, it can be canceled by stopping the drive. • The ID run must be performed every time any of the motor parameters (<i>99.04</i>, <i>99.06...99.12</i>) have been changed. • With scalar control mode (<i>99.04 Motor control mode = Scalar</i>), the ID run is not requested automatically. However, an ID run can be performed for more accurate torque estimation. • Ensure that the Safe torque off and emergency stop circuits (if any) are closed during the ID run. • Mechanical brake (if present) is not opened by the logic for the ID run. • This parameter cannot be changed while the drive is running. 	<i>None</i>
	None	<p>No motor ID run is requested. This mode can be selected only if the ID run (<i>Normal/ Reduced/ Standstill/ Advanced</i>) has already been performed once.</p>	0

No.	Name/Value	Description	Default FbEq 16
	Normal	<p>Normal ID run. Guarantees good control accuracy for all cases. The ID run takes about 90 seconds. This mode should be selected whenever it is possible.</p> <p>Notes:</p> <ul style="list-style-type: none"> • If the load torque will be higher than 20% of motor nominal torque, or if the machinery is not able to withstand the nominal torque transient during the ID run, then the driven machinery must be de-coupled from the motor during a Normal ID run. • Check the direction of rotation of the motor before starting the ID run. During the run, the motor will rotate in the forward direction. <p> WARNING! The motor will run at up to approximately 50...100% of the nominal speed during the ID run. ENSURE THAT IT IS SAFE TO RUN THE MOTOR BEFORE PERFORMING THE ID RUN!</p>	1
	Reduced	<p>Reduced ID run. This mode should be selected instead of the <i>Normal</i> or <i>Advanced</i> ID Run if</p> <ul style="list-style-type: none"> • mechanical losses are higher than 20% (ie. the motor cannot be de-coupled from the driven equipment), or if • flux reduction is not allowed while the motor is running (ie. in case of a motor with an integrated brake supplied from the motor terminals). <p>With this ID run mode, the resultant motor control in the field weakening area or at high torques is not necessarily as accurate as motor control following a Normal ID run. Reduced ID run is completed faster than the Normal ID Run (< 90 seconds).</p> <p>Note: Check the direction of rotation of the motor before starting the ID run. During the run, the motor will rotate in the forward direction.</p> <p> WARNING! The motor will run at up to approximately 50...100% of the nominal speed during the ID run. ENSURE THAT IT IS SAFE TO RUN THE MOTOR BEFORE PERFORMING THE ID RUN!</p>	2
	Standstill	<p>Standstill ID run. The motor is injected with DC current. With an AC induction (asynchronous) motor, the motor shaft is not rotated. With a permanent magnet motor, the shaft can rotate up to half a revolution.</p> <p>Note: This mode should be selected only if the <i>Normal</i>, <i>Reduced</i> or <i>Advanced</i> ID run is not possible due to the restrictions caused by the connected mechanics (e.g. with lift or crane applications).</p>	3

No.	Name/Value	Description	Default FbEq 16
	Advanced	<p>Advanced ID run. Guarantees the best possible control accuracy. The ID run takes a very long time to complete. This mode should be selected when top performance is needed across the whole operating area.</p> <p>Note: The driven machinery must be de-coupled from the motor because of high torque and speed transients that are applied.</p> <p> WARNING! The motor may run at up to the maximum (positive) and minimum (negative) allowed speed during the ID run. Several accelerations and decelerations are done. The maximum torque, current and speed allowed by the limit parameters may be utilized. ENSURE THAT IT IS SAFE TO RUN THE MOTOR BEFORE PERFORMING THE ID RUN!</p>	6
	Adaptive	The drive makes a Standstill ID run first. After that, the motor parameters will be refined during the normal operation to achieve more optimal performance. After the motor model adaptation process is complete, parameter 99.14 will be changed from <i>Standstill</i> to <i>Adaptive</i> .	8
99.14	<i>Last ID run performed</i>	Shows the type of ID run that was performed last.	<i>None</i>
	None	No ID run has been performed.	0
	Normal	<i>Normal</i> ID run.	1
	Reduced	<i>Reduced</i> ID run.	2
	Standstill	<i>Standstill</i> ID run.	3
	Advanced	<i>Advanced</i> ID run.	6
	Adaptive	<i>Adaptive</i> ID run.	
99.15	<i>Motor polepairs calculated</i>	Calculated number of pole pairs in the motor.	0
	0...1000	Number of pole pairs.	1 = 1
99.16	<i>Motor phase order</i>	<p>Switches the rotation direction of motor. This parameter can be used if the motor turns in the wrong direction (for example, because of the wrong phase order in the motor cable), and correcting the cabling is considered impractical.</p> <p>Notes:</p> <ul style="list-style-type: none"> Changing this parameter does not affect speed reference polarities, so positive speed reference will rotate the motor forward. The phase order selection just ensures that "forward" is in fact the correct direction. 	<i>U V W</i>
	U V W	Normal.	0
	U W V	Reversed rotation direction.	1

Differences in the default values between 50 Hz and 60 Hz supply frequency settings

Parameter *95.20 HW options word 1* bit 0 changes the drive parameter default values according to the supply frequency, 50 Hz or 60 Hz. The bit is set according to the market before the drive is delivered.

If you need to change from 50 Hz to 60 Hz, or vice versa, change the value of the bit and then do a complete reset to the drive (*96.06 Parameter restore*). After that you have to reselect the macro to be used.

The table below shows the parameters whose default values depend on the supply frequency setting. The supply frequency setting, with the type designation of the drive, also affects group *99 Motor data* parameter values (not listed in the table).

No.	Name	95.20 HW options word 1 bit 0 Supply frequency 60 Hz = 50 Hz	95.20 HW options word 1 bit 0 Supply frequency 60 Hz = 60 Hz
11.45	<i>Freq in 1 at scaled max</i>	1500.000	1800.000
12.20	<i>All scaled at All max</i>	1500.000	1800.000
13.18	<i>AO1 source max</i>	1500.0	1800.0
22.26	<i>Constant speed 1</i>	300.00 rpm	360.00 rpm
22.27	<i>Constant speed 2</i>	600.00 rpm	720.00 rpm
22.28	<i>Constant speed 3</i>	900.00 rpm	1080.00 rpm
22.29	<i>Constant speed 4</i>	1200.00 rpm	1440.00 rpm
22.30	<i>Constant speed 5</i>	1500.00 rpm	1800.00 rpm
22.31	<i>Constant speed 6</i>	2400.00 rpm	2880.00 rpm
22.32	<i>Constant speed 7</i>	3000.00 rpm	3600.00 rpm
28.26	<i>Constant frequency 1</i>	5.00 Hz	6.00 Hz
28.27	<i>Constant frequency 2</i>	10.00 Hz	12.00 Hz
28.28	<i>Constant frequency 3</i>	15.00 Hz	18.00 Hz
28.29	<i>Constant frequency 4</i>	20.00 Hz	24.00 Hz
28.30	<i>Constant frequency 5</i>	25.00 Hz	30.00 Hz
28.31	<i>Constant frequency 6</i>	40.00 Hz	48.00 Hz
28.32	<i>Constant frequency 7</i>	50.00 Hz	60.00 Hz
30.11	<i>Minimum speed</i>	-1500.00 rpm	-1800.00 rpm
30.12	<i>Maximum speed</i>	1500.00 rpm	1800.00 rpm
30.13	<i>Minimum frequency</i>	-50.00 Hz	-60.00 Hz
30.14	<i>Maximum frequency</i>	50.00 Hz	60.00 Hz
31.26	<i>Stall speed limit</i>	150.00 rpm	180.00 rpm
31.27	<i>Stall frequency limit</i>	15.00 Hz	18.00 Hz
31.30	<i>Overspeed trip margin</i>	500.00 rpm	500.00 rpm
46.01	<i>Speed scaling</i>	1500.00 rpm	1800.00 rpm
46.02	<i>Frequency scaling</i>	50.00 Hz	60.00 Hz

Parameters supported by Modbus backwards compatibility with legacy drives

ACx310/320/355 compatibility mode is a way to communicate with an ACxx80 drive in such a way that it looks like an ACx310/320/355 drive over Modbus RTU or Modbus TCP. This mode can be enabled by changing parameter *96.78 Legacy Modbus mapping* to Enable.

In the ACx310/320/355 compatibility mode all supported parameters can be read as if the drive were an ACx310/320/355. Some parameters are read only and do not support writes. See the table below to see which parameters support writes.

ACx310/ 320/355 parameter	Name	Read/Write
01.01	SPEED & DIR	Read only
01.02	SPEED	Read only
01.03	OUTPUT FREQ	Read only
01.04	CURRENT	Read only
01.05	TORQUE	Read only
01.06	POWER	Read only
01.07	DC BUS VOLTAGE	Read only
01.09	OUTPUT VOLTAGE	Read only
01.10	DRIVE TEMP	Read only
01.11	EXTERNAL REF 1	Read only
01.13	CTRL LOCATION	Read only
01.14	RUN TIME	Read only
01.15	KWH COUNTER	Read only
01.18	DI 1-3 STATUS	Read only
01.19	DI 4-6 STATUS	Read only
01.20	AI 1	Read only
01.21	AI 2	Read only
01.22	RO 1-3 STATUS	Read only
01.23	RO 4-6 STATUS	Read only
01.24	AO 1	Read only
01.25	AO 2	Read only
01.26	PID 1 OUTPUT	Read only
01.27	PID 2 OUTPUT	Read only
01.28	PID 1 SETPNT	Read only
01.29	PID 2 SETPNT	Read only
01.30	PID 1 FBK	Read only
01.31	PID 2 FBK	Read only
01.32	PID 1 DEVIATION	Read only
01.33	PID 2 DEVIATION	Read only

ACx310/ 320/355 parameter	Name	Read/Write
01.34	COMM RO WORD	Read only
01.35	COMM VALUE 1	Read only
01.36	COMM VALUE 2	Read only
01.41	MWH COUNTER	Read only
01.43	DRIVE ON TIME	Read only
01.45	MOTOR TEMP	Read only
01.50	CB TEMP	Read only
01.74	SAVED KWH	Read only
01.75	SAVED MWH	Read only
01.77	SAVED AMOUNT 2	Read only
01.78	SAVED CO2	Read only
03.01	FB CMD WORD 1	Read only
03.02	FB CMD WORD 2	Read only
03.03	FB STS WORD 1	Read only
03.04	FB STS WORD 2	Read only
03.05	FAULT WORD 1	Read only
03.06	FAULT WORD 2	Read only
03.07	FAULT WORD 3	Read only
03.08	ALARM WORD 1	Read only
03.09	ALARM WORD 2	Read only
04.01	LAST FAULT	Read only
04.12	PREVIOUS FAULT 1	Read only
04.13	PREVIOUS FAULT 2	Read only
10.01	EXT1 COMMANDS	Read/Write
10.02	EXT2 COMMANDS	Read/Write
10.03	DIRECTION	Read/Write
10.04	JOGGING SEL	Read/Write
11.02	EXT1/EXT2 SEL	Read/Write
11.03	REF1 SELECT	Read/Write

320 Parameters

ACx310/ 320/355 parameter	Name	Read/Write
11.04	REF1 MIN	Read/Write
11.05	REF1 MAX	Read/Write
11.06	REF2 SEL	Read/Write
11.07	REF2 MIN	Read/Write
11.08	REF2 MAX	Read/Write
12.01	CONST SPEED SEL	Read/Write
12.02	CONST SPEED 1	Read/Write
12.03	CONST SPEED 2	Read/Write
12.04	CONST SPEED 3	Read/Write
12.05	CONST SPEED 4	Read/Write
12.06	CONST SPEED 5	Read/Write
12.07	CONST SPEED 6	Read/Write
15.02	CONST SPEED 7	Read/Write
15.03	AO1 CONTENT MAX	Read/Write
15.04	MINIMUM AO1	Read/Write
15.05	MAXIMUM AO1	Read/Write
15.08	AO2 CONTENT MIN	Read/Write
15.09	AO2 CONTENT MAX	Read/Write
15.10	MINIMUM AO2	Read/Write
15.11	MAXIMUM AO2	Read/Write
16.01	RUN ENABLE	Read/Write
16.02	PARAMETER LOCK	Read/Write
16.03	PASS CODE	Read/Write
16.08	START ENABLE 1	Read/Write
16.09	START ENABLE 2	Read/Write
20.01	MINIMUM SPEED	Read/Write
20.02	MAXIMUM SPEED	Read/Write
20.03	MAX CURRENT	Read/Write
20.06	UNDERVOLT CTRL	Read/Write
20.07	MINIMUM FREQ	Read/Write
20.08	MAXIMUM FREQ	Read/Write
20.13	MIN TORQUE SEL	Read/Write
20.14	MAX TORQUE SEL	Read/Write
20.15	MIN TORQUE 1	Read/Write
20.16	MIN TORQUE 2	Read/Write
20.17	MAX TORQUE 1	Read/Write
20.18	MAX TORQUE 2	Read/Write
21.02	STOP FUNCTION	Read/Write
21.03	DC MAGN TIME	Read/Write

ACx310/ 320/355 parameter	Name	Read/Write
21.05	DC HOLD SPEED	Read/Write
21.06	DC CURR REF	Read/Write
21.09	EMERG STOP SEL	Read/Write
21.12	ZERO SPEED DELAY	Read/Write
21.13	START DELAY	Read/Write
22.02	ACCELER TIME 1	Read/Write
22.03	DECELER TIME 1	Read/Write
22.04	RAMP SHAPE 1	Read/Write
22.05	ACCELER TIME 2	Read/Write
22.06	DECELER TIME 2	Read/Write
22.07	RAMP SHAPE 2	Read/Write
22.08	EMERG DEC TIME	Read/Write
23.01	PROP GAIN	Read/Write
23.02	INTEGRATION TIME	Read/Write
23.03	DERIVATION TIME	Read/Write
23.04	ACC COMPENSATION	Read/Write
30.02	PANEL COMM ERR	Read/Write
30.03	EXTERNAL REF 1	Read/Write
30.04	EXTERNAL REF 2	Read/Write
30.05	MOT THERM POT	Read/Write
30.06	MOT THERM TIME	Read/Write
30.07	MOT LOAD CURVE	Read/Write
30.08	ZERO SPEED LOAD	Read/Write
30.09	BREAK POINT FREQ	Read/Write
30.10	STALL FUNCTION	Read/Write
30.11	STALL FREQUENCY	Read/Write
30.12	STALL TIME	Read/Write
30.17	EARTH FAULT	Read/Write
30.18	COMM FAULT FUNC	Read/Write
30.19	COMM FAULT TIME	Read/Write
30.22	AI2 FAULT LIMIT	Read/Write
30.23	WIRING FAULT	Read/Write
33.01	FIRMWARE	Read only
33.02	LOADING PACKAGE	Read only
33.03	TEST DATE	Read only
33.04	DRIVE RATING	Read only
40.01	GAIN	Read/Write
40.02	INTEGRATION TIME	Read/Write
40.03	DERIVATION TIME	Read/Write

ACx310/ 320/355 parameter	Name	Read/Write
40.04	PID DERIV FILTER	Read/Write
40.08	0% VALUE	Read/Write
40.09	100% VALUE	Read/Write
40.10	SET POINT SEL	Read/Write
40.11	INTERNAL SETPNT	Read/Write
40.12	SETPOINT MIN	Read/Write
40.13	SETPOINT MAX	Read/Write
40.14	FBK SEL	Read/Write
40.15	FBK MULTIPLIER	Read/Write
40.16	ACT 1 INPUT	Read/Write
40.17	ACT 2 INPUT	Read/Write
40.24	PID SLEEP DELAY	Read/Write
40.25	WAKE-UP DEV	Read/Write
40.26	WAKE-UP DELAY	Read/Write
40.27	PID 1 PARAM SET	Read/Write
41.01	GAIN	Read/Write
41.02	INTEGRATION TIME	Read/Write
41.03	DERIVATION TIME	Read/Write
41.04	PID DERIV FILTER	Read/Write
41.08	0% VALUE	Read/Write
41.09	100% VALUE	Read/Write
41.10	SET POINT SEL	Read/Write

ACx310/ 320/355 parameter	Name	Read/Write
41.11	INTERNAL SETPNT	Read/Write
41.12	SETPOINT MIN	Read/Write
41.13	SETPOINT MAX	Read/Write
41.14	FBK SEL	Read/Write
41.15	FBK MULTIPLIER	Read/Write
41.16	ACT 1 INPUT	Read/Write
41.17	ACT 2 INPUT	Read/Write
41.24	PID SLEEP DELAY	Read/Write
41.25	WAKE-UP DEV	Read/Write
41.26	WAKE-UP DELAY	Read/Write
42.11	INTERNAL SETPNT	Read/Write
53.05	EFB CTRL PROFILE	Read/Write
99.01	LANGUAGE	Read/Write
99.04	MOTOR CTRL MODE	Read/Write
99.05	MOTOR NOM VOLT	Read/Write
99.06	MOTOR NOM CURR	Read/Write
99.07	MOTOR NOM FREQ	Read/Write
99.08	MOTOR NOM SPEED	Read/Write
99.09	MOTOR NOM POWER	Read/Write
99.10	ID RUN	Read/Write
99.15	MOTOR COS PHI	Read/Write

7

Additional parameter data

What this chapter contains

- *Terms and abbreviations*
- *Fieldbus addresses*
- *Parameter groups 1...9*
- *Parameter groups 10...99*

Terms and abbreviations

Term	Definition
Actual signal	Signal measured or calculated by the drive. Usually can only be monitored but not adjusted; some counter-type signals can however be reset.
Analog src	Analog source: the parameter can be set to the value of another parameter by choosing "Other", and selecting the source parameter from a list. In addition to the "Other" selection, the parameter may offer other pre-selected settings.
Binary src	Binary source: the value of the parameter can be taken from a specific bit in another parameter value ("Other"). Sometimes the value can be fixed to 0 (false) or 1 (true). In addition, the parameter may offer other pre-selected settings.
Data	Data parameter.
FbEq32	32-bit fieldbus equivalent: The scaling between the value shown on the panel and the integer used in communication when a 32-bit value is selected for transmission to an external system. The corresponding 16-bit scalings are listed in chapter <i>Parameters</i> .
List	Selection list.

Term	Definition
No.	Parameter number.
PB	Packed Boolean (bit list).
Real	Real number.
Type	Parameter type. See <i>Analog src, Binary src, List, PB, Real</i> .
Uint16	16-bit unsigned integer.

Fieldbus addresses

Refer to *Fieldbus control through the embedded fieldbus interface (EFB)*.

Parameter groups 1...9

No.	Name	Type	Range	Unit	FbEq32
01 Actual values					
01.01	Motor speed used	<i>Real</i>	-30000.00...30000.00	rpm	100 = 1 rpm
01.03	Motor speed %	<i>Real</i>	-1000.00...1000.00	%	100 = 1%
01.06	Output frequency	<i>Real</i>	-500.00...500.00	Hz	100 = 1 Hz
01.07	Motor current	<i>Real</i>	0.00...30000.00	A	100 = 1 A
01.08	Motor current % of motor nom	<i>Real</i>	0.0...1000.0	%	10 = 1%
01.09	Motor current % of drive nom	<i>Real</i>	0.0...1000.0	%	10 = 1%
01.10	Motor torque	<i>Real</i>	-1600.0...1600.0	%	10 = 1%
01.11	DC voltage	<i>Real</i>	0.00...2000.00	V	100 = 1 V
01.13	Output voltage	<i>Real</i>	0...2000	V	1 = 1 V
01.14	Output power	<i>Real</i>	-32768.00...32767.00	kW or hp	100 = 1 unit
01.15	Output power % of motor nom	<i>Real</i>	-300.00...300.00	%	100 = 1%
01.17	Motor shaft power	<i>Real</i>	-32768.00...32767.00	kW or hp	100 = 1 unit
01.18	<i>Inverter GWh counter</i>	<i>Real</i>	0...65535	GWh	1 = 1 GWh
01.19	<i>Inverter MWh counter</i>	<i>Real</i>	0...1000	MWh	1 = 1 MWh
01.20	<i>Inverter kWh counter</i>	<i>Real</i>	0...1000	kWh	1 = 1 kWh
01.24	<i>Flux actual %</i>	<i>Real</i>	0...200	%	1 = 1%
01.30	<i>Nominal torque scale</i>	<i>Real</i>	0.000...4000000	N·m or lb·ft	1000 = 1 unit
01.50	<i>Current hour kWh</i>	<i>Real</i>	-21474836.48... 21474836.47	kWh	100 = 1 kWh
01.51	<i>Previous hour kWh</i>	<i>Real</i>	-21474836.48... 21474836.47	kWh	100 = 1 kWh
01.52	<i>Current day kWh</i>	<i>Real</i>	-21474836.48... 21474836.47	kWh	100 = 1 kWh
01.53	<i>Previous day kWh</i>	<i>Real</i>	-21474836.48... 21474836.47	kWh	100 = 1 kWh
01.54	Cumulative inverter energy	<i>Real</i>	-200000000.0... 200000000.0	kWh	1 = 1 kWh
01.55	Inverter GWh counter (resettable)	<i>Real</i>	0...65535	GWh	1 = 1 GWh
01.56	Inverter MWh counter (resettable)	<i>Real</i>	0...1000	MWh	1 = 1 MWh
01.57	Inverter kWh counter (resettable)	<i>Real</i>	0...1000	kWh	1 = 1 kWh
01.58	Cumulative inverter energy (resettable)	<i>Real</i>	-200000000.0... 200000000.0	kWh	1 = 1 kWh
01.61	Abs motor speed used	<i>Real</i>	0.00... 30000.00	rpm	100 = 1 rpm
01.62	Abs motor speed %	<i>Real</i>	0.00... 100.00%	%	100 = 1%
01.63	Abs output frequency	<i>Real</i>	0.00...500.00 Hz	Hz	100 = 1 Hz
01.64	Abs motor torque	<i>Real</i>	0.00...1600.0	%	10 = 1%

326 Additional parameter data

No.	Name	Type	Range	Unit	FbEq32
01.65	Abs output power	<i>Real</i>	0.00... 32767.00	kW	100 = 1 kW
01.66	Abs output power % motor nom	<i>Real</i>	0.00...300.00	%	100 = 1%
01.68	Abs motor shaft power	<i>Real</i>	0.00... 32767.00	kW	100 = 1 kW
03 Input references					
03.01	<i>Panel reference</i>	<i>Real</i>	-100000.00...100000.00	-	100 = 1
03.02	<i>Panel reference remote</i>	<i>Real</i>	-100000.00...100000.00	-	100 = 1 unit
03.09	<i>EFB reference 1</i>	<i>Real</i>	-30000.00...30000.00	-	100 = 1
03.10	<i>EFB reference 2</i>	<i>Real</i>	-30000.00...30000.00	-	100 = 1
03.17	Integrated Panel ref	<i>Real</i>	-100000.00...100000.00	-	100 = 1
03.18	Integrated Panel ref remote	<i>Real</i>	-100000.00...100000.00	-	100 = 1
04 Warnings and faults					
04.01	Tripping fault	<i>Data</i>	0000h...FFFFh	-	1 = 1
04.02	Active fault 2	<i>Data</i>	0000h...FFFFh	-	1 = 1
04.03	Active fault 3	<i>Data</i>	0000h...FFFFh	-	1 = 1
04.06	Active warning 1	<i>Data</i>	0000h...FFFFh	-	1 = 1
04.07	Active warning 2	<i>Data</i>	0000h...FFFFh	-	1 = 1
04.08	Active warning 3	<i>Data</i>	0000h...FFFFh	-	1 = 1
04.11	Latest fault	<i>Data</i>	0000h...FFFFh	-	1 = 1
04.12	2nd latest fault	<i>Data</i>	0000h...FFFFh	-	1 = 1
04.13	3rd latest fault	<i>Data</i>	0000h...FFFFh	-	1 = 1
04.16	Latest warning	<i>Data</i>	0000h...FFFFh	-	1 = 1
04.17	2nd latest warning	<i>Data</i>	0000h...FFFFh	-	1 = 1
04.18	3rd latest warning	<i>Data</i>	0000h...FFFFh	-	1 = 1
04.40	Event word 1	<i>Data</i>	0000h...FFFFh	-	1 = 1
04.41	Event word 1 bit 0 code	<i>Data</i>	0000h...FFFFh	-	1 = 1
04.43	Event word 1 bit 1 code	<i>Data</i>	0000h...FFFFh	-	1 = 1
04.45	Event word 1 bit 2 code	<i>Data</i>	0000h...FFFFh	-	1 = 1
04.47	Event word 1 bit 3 code	<i>Data</i>	0000h...FFFFh	-	1 = 1
04.49	Event word 1 bit 4 code	<i>Data</i>	0000h...FFFFh	-	1 = 1
04.51	Event word 1 bit 5 code	<i>Data</i>	0000h...FFFFh	-	1 = 1
04.53	Event word 1 bit 6 code	<i>Data</i>	0000h...FFFFh	-	1 = 1
04.55	Event word 1 bit 7 code	<i>Data</i>	0000h...FFFFh	-	1 = 1
04.57	Event word 1 bit 8 code	<i>Data</i>	0000h...FFFFh	-	1 = 1
04.59	Event word 1 bit 9 code	<i>Data</i>	0000h...FFFFh	-	1 = 1
04.61	Event word 1 bit 10 code	<i>Data</i>	0000h...FFFFh	-	1 = 1
04.63	Event word 1 bit 11 code	<i>Data</i>	0000h...FFFFh	-	1 = 1
04.65	Event word 1 bit 12 code	<i>Data</i>	0000h...FFFFh	-	1 = 1
04.67	Event word 1 bit 13 code	<i>Data</i>	0000h...FFFFh	-	1 = 1
04.69	Event word 1 bit 14 code	<i>Data</i>	0000h...FFFFh	-	1 = 1
04.71	Event word 1 bit 15 code	<i>Data</i>	0000h...FFFFh	-	1 = 1

No.	Name	Type	Range	Unit	FbEq32
05 Diagnostics					
05.01	On-time counter	Real	0...65535	d	1 = 1 d
05.02	Run-time counter	Real	0...65535	d	1 = 1 d
05.03	Hours run	Real	0.0...429496729.5	h	10 = 1 h
05.04	Fan on-time counter	Real	0...65535	d	1 = 1 d
05.10	Control board temperature	Real	-100...300 °C	°C or °F	10 = 1 °C
05.11	Inverter temperature	Real	-40.0...160.0	%	10 = 1%
05.20	Diagnostic word 1	PB	0b0000...0b1111	-	-
05.21	Diagnostic word 2	PB	0b0000...0b1111	-	-
05.22	Diagnostic word 3	PB	0b0000...0b1111	-	-
05.80	Motor speed at fault	Real	-30000.00...30000.00	rpm	100 = 1 rpm
05.81	Output frequency at fault	Real	-500.00...500.00	Hz	100 = 1 Hz
05.82	DC voltage at fault	Real	0.00...2000.00	V	100 = 1 V
05.83	Motor current at fault	Real	0.00...30000.00	A	100 = 1 A
05.84	Motor torque at fault	Real	-1600.0...1600.0	%	10 = 1%
05.85	Main status word at fault	PB	0000h...FFFFh	-	1 = 1
05.86	DI delayed status at fault	PB	0000h...FFFFh	-	1 = 1
05.87	Inverter temperature at fault	PB	-40.0...160.0	°C	10 = 1°C
05.88	Reference used at fault	Real	-500.00...500.00 Hz/ -1600.0...1600.0%/ 30000.00...30000.00 rpm	Hz/ %/ rpm	100 = 1 Hz/ 10 = 1%/ 100 = 1 rpm
06 Control and status words					
06.01	Main control word	PB	0000h...FFFFh	-	1 = 1
06.11	Main status word	PB	0000h...FFFFh	-	1 = 1
06.16	Drive status word 1	PB	0000h...FFFFh	-	1 = 1
06.17	Drive status word 2	PB	0000h...FFFFh	-	1 = 1
06.18	Start inhibit status word	PB	0000h...FFFFh	-	1 = 1
06.19	Speed control status word	PB	0000h...FFFFh	-	1 = 1
06.20	Constant speed status word	PB	0000h...FFFFh	-	1 = 1
06.21	Drive status word 3	PB	0000h...FFFFh	-	1 = 1
06.29	MSW bit 10 selection	Binary src	-	-	1 = 1
06.30	MSW bit 11 selection	Binary src	-	-	1 = 1
06.31	MSW bit 12 selection	Binary src	-	-	1 = 1
06.32	MSW bit 13 selection	Binary src	-	-	1 = 1
06.33	MSW bit 14 selection	Binary src	-	-	1 = 1
07 System info					
07.03	Drive rating id	List	-	-	1 = 1
07.04	Firmware name	List	-	-	1 = 1

328 *Additional parameter data*

No.	Name	Type	Range	Unit	FbEq32
07.05	Firmware version	<i>Data</i>	-	-	1 = 1
07.06	Loading package name	<i>List</i>	-	-	1 = 1
07.07	Loading package version	<i>Data</i>	-	-	1 = 1
07.11	Cpu usage	<i>Real</i>	0...100	%	1 = 1%
07.25	Customization package name	<i>Data</i>	-	-	1 = 1
07.26	Customization package version	<i>Data</i>	-	-	1 = 1
07.30	Adaptive program status	<i>PB</i>	0000h...FFFFh	-	1 = 1
07.31	AP sequence state	<i>Data</i>	0...20	-	1 = 1

Parameter groups 10...99

No.	Name	Type	Range	Unit	FbEq32
10 Standard DI, RO					
10.01	DI status	<i>PB</i>	0000h...FFFFh	-	1 = 1
10.02	DI delayed status	<i>PB</i>	0000h...FFFFh	-	1 = 1
10.03	DI force selection	<i>PB</i>	0000h...FFFFh	-	1 = 1
10.04	DI forced data	<i>PB</i>	0000h...FFFFh	-	1 = 1
10.04	DI forced data	<i>PB</i>	0000h...FFFFh	-	1 = 1
10.05	DI1 ON delay	<i>PB</i>	0.0...3000.0	s	10 = 1 s
10.06	DI1 OFF delay	<i>PB</i>	0.0...3000.0	s	10 = 1 s
10.07	DI2 ON delay	<i>PB</i>	0.0...3000.0	s	10 = 1 s
10.08	DI2 OFF delay	<i>PB</i>	0.0...3000.0	s	10 = 1 s
10.09	DI3 ON delay	<i>PB</i>	0.0...3000.0	s	10 = 1 s
10.10	DI3 OFF delay	<i>PB</i>	0.0...3000.0	s	10 = 1 s
10.11	DI4 ON delay	<i>PB</i>	0.0...3000.0	s	10 = 1 s
10.12	DI4 OFF delay	<i>PB</i>	0.0...3000.0	s	10 = 1 s
10.13	DI5 ON delay	<i>PB</i>	0.0...3000.0	s	10 = 1 s
10.14	DI5 OFF delay	<i>PB</i>	0.0...3000.0	s	10 = 1 s
10.21	RO status	<i>PB</i>	0000h...FFFFh	-	1 = 1
10.22	RO force selection	<i>PB</i>	0000h...FFFFh	-	1 = 1
10.23	RO forced data	<i>PB</i>	0000h...FFFFh	-	1 = 1
10.24	RO1 source	<i>Binary src</i>	-	-	1 = 1
10.25	RO1 ON delay	<i>Real</i>	0.0...3000.0	s	10 = 1 s
10.26	RO1 OFF delay	<i>Real</i>	0.0...3000.0	s	10 = 1 s
10.99	RO/DIO control word	<i>PB</i>	0000h...FFFFh	-	1 = 1
10.101	RO1 toggle counter	<i>Real</i>	0...4294967000	-	1 = 1
11 Standard DIO, FI, FO					
11.02	DIO delayed status	<i>PB</i>	0000h...FFFFh	-	1 = 1
11.03	DIO force selection	<i>PB</i>	0000h...FFFFh	-	1 = 1
11.04	DO1 force data	<i>PB</i>	0000h...FFFFh	-	1 = 1
11.06	DO1 output source	<i>Binary src</i>	-	-	1 = 1
11.07	DO1 ON delay	<i>Real</i>	0.0...3000.0	s	10 = 1 s
11.08	DO1 OFF delay	<i>Real</i>	0.0...3000.0	s	10 = 1 s
11.13	DI3 configuration	<i>List</i>	0, 1	-	1 = 1
11.17	DI4 configuration	<i>List</i>	0, 1	-	1 = 1
11.21	DI5 configuration	<i>List</i>	0, 1	-	1 = 1
11.38	Freq in 1 actual value	<i>Real</i>	0...16000	Hz	1 = 1 Hz
11.39	Freq in 1 scaled value	<i>Real</i>	-32768.000...32767.000	-	1000 = 1
11.42	Freq in 1 min	<i>Real</i>	0...16000	Hz	1 = 1 Hz
11.43	Freq in 1 max	<i>Real</i>	0...16000	Hz	1 = 1 Hz
11.44	Freq in 1 at scaled min	<i>Real</i>	-32768.000...32767.000	-	1000 = 1

330 Additional parameter data

No.	Name	Type	Range	Unit	FbEq32
11.45	Freq in 1 at scaled max	<i>Real</i>	-32768.000...32767.000	-	1000 = 1
11.46	Freq in 2 actual value	<i>Real</i>	0...16000	Hz	1 = 1
11.47	Freq in 2 scaled	<i>Real</i>	-32768.000...32767.000	-	1000 = 1
11.50	Freq in 2 min	<i>Real</i>	0...16000	Hz	1 = 1
11.51	Freq in 2 max	<i>Real</i>	0...16000	Hz	1 = 1
11.52	Freq in 2 at scaled min	<i>Real</i>	-32768.000...32767.000	-	1 = 1
11.53	Freq in 2 at scaled max	<i>Real</i>	-32768.000...32767.000	-	1 = 1
12 Standard AI					
12.02	AI force selection	<i>PB</i>	0000h...FFFFh	-	1 = 1
12.03	AI supervision function	<i>List</i>	0...4	-	1 = 1
12.04	AI supervision selection	<i>PB</i>	0000h...FFFFh	-	1 = 1
12.05	AI supervision force	<i>PB</i>	0000h...FFFFh	-	1 = 1
12.11	AI1 actual value	<i>Real</i>	4.000...20.000 mA or 0.000...10.000 V	mA or V	1000 = 1 unit
12.12	AI1 scaled value	<i>Real</i>	-32768.000...32767.000	-	1000 = 1
12.13	AI1 forced value	<i>Real</i>	4.000...20.000 mA or 0.000...10.000 V	mA or V	1000 = 1 unit
12.15	AI1 unit selection	<i>List</i>	2, 10	-	1 = 1
12.16	AI1 filter time	<i>Real</i>	0.000...30.000	s	1000 = 1 s
12.17	AI1 min	<i>Real</i>	4.000...20.000 mA or 0.000...10.000 V	mA or V	1000 = 1 unit
12.18	AI1 max	<i>Real</i>	0.000...20.000 mA or 0.000...10.000 V	mA or V	1000 = 1 unit
12.19	AI1 scaled at AI1 min	<i>Real</i>	-32768.000...32767.000	-	1000 = 1
12.20	AI1 scaled at AI1 max	<i>Real</i>	-32768.000...32767.000	-	1000 = 1
12.21	AI2 actual value	<i>Real</i>	4.000...20.000 mA or 0.000...10.000 V	mA or V	1000 = 1 unit
12.22	AI2 scaled value	<i>Real</i>	-32768.000...32767.000	-	1000 = 1
12.23	AI2 forced value	<i>Real</i>	4.000...20.000 mA or 0.000...10.000 V	mA or V	1000 = 1 unit
12.25	AI2 unit selection	<i>List</i>	2, 10	-	1 = 1
12.26	AI2 filter time	<i>Real</i>	0.000...30.000	s	1000 = 1 s
12.27	AI2 min	<i>Real</i>	4.000...20.000 mA or 0.000...10.000 V	mA or V	1000 = 1 unit
12.28	AI2 max	<i>Real</i>	4.000...20.000 mA or 0.000...10.000 V	mA or V	1000 = 1 unit
12.29	AI2 scaled at AI2 min	<i>Real</i>	-32768.000...32767.000	-	1000 = 1
12.30	AI2 scaled at AI2 max	<i>Real</i>	-32768.000...32767.000	-	1000 = 1
12.101	AI1 percent value	<i>Real</i>	0.00...100.00	%	100 = 1%
12.102	AI2 percent value	<i>Real</i>	0.00...100.00	%	100 = 1%
12.110	AI dead band	<i>Real</i>	0.00...100.00	%	0
13 Standard AO					
13.02	AO force selection	<i>PB</i>	0000h...FFFFh	-	1 = 1
13.11	AO1 actual value	<i>Real</i>	0.000...22.000	mA	1000 = 1 mA

No.	Name	Type	Range	Unit	FbEq32
13.12	AO1 source	<i>Analog src</i>	-	-	1 = 1
13.13	AO1 forced value	<i>Real</i>	0.000...22.000	mA	1000 = 1 mA
13.15	AO1 unit selection	<i>List</i>	2, 10	-	1 = 1
13.16	AO1 filter time	<i>Real</i>	0.000...30.000	s	1000 = 1 s
13.17	AO1 source min	<i>Real</i>	-32768.0...32767.0	-	10 = 1
13.18	AO1 source max	<i>Real</i>	-32768.0...32767.0	-	10 = 1
13.19	AO1 out at AO1 src min	<i>Real</i>	0.000...22.000	mA	1000 = 1 mA
13.20	AO1 out at AO1 src max	<i>Real</i>	0.000...22.000	mA	1000 = 1 mA
13.91	AO1 data storage	<i>Real</i>	-327.68 ... 327.67	-	100 = 1
19 Operation mode					
19.01	Actual operation mode	<i>List</i>	1...5, 10, 20	-	1 = 1
19.11	Ext1/Ext2 selection	<i>Binary src</i>	-	-	1 = 1
19.12	Ext1 control mode	<i>List</i>	1...5	-	1 = 1
19.14	Ext2 control mode	<i>List</i>	1...5	-	1 = 1
19.16	Local control mode	<i>List</i>	0...1	-	1 = 1
19.17	Local control disable	<i>List</i>	0...1	-	1 = 1
20 Start/stop/direction					
20.01	Ext1 commands	<i>List</i>	0...6, 11...12, 14...16, 21...23	-	1 = 1
20.02	Ext1 start trigger type	<i>List</i>	0...1	-	1 = 1
20.03	Ext1 in1 source	<i>Binary src</i>	-	-	1 = 1
20.04	Ext1 in2 source	<i>Binary src</i>	-	-	1 = 1
20.05	Ext1 in3 source	<i>Binary src</i>	-	-	1 = 1
20.06	Ext2 commands	<i>List</i>	0...6, 11...12, 14, 21...23	-	1 = 1
20.07	Ext2 start trigger type	<i>List</i>	0...1	-	1 = 1
20.08	Ext2 in1 source	<i>Binary src</i>	-	-	1 = 1
20.09	Ext2 in2 source	<i>Binary src</i>	-	-	1 = 1
20.10	Ext2 in3 source	<i>Binary src</i>	-	-	1 = 1
20.11	Run enable stop mode	<i>List</i>	0...2	-	1 = 1
20.12	Run enable 1 source	<i>Binary src</i>	-	-	1 = 1
20.19	Enable start command	<i>Binary src</i>	-	-	1 = 1
20.21	Direction	<i>List</i>	0...2	-	1 = 1
20.22	Enable to rotate	<i>Binary src</i>	-	-	1 = 1
20.25	Jogging enable	<i>Binary src</i>	-	-	1 = 1
20.26	Jogging 1 start source	<i>Binary src</i>	-	-	1 = 1
20.27	Jogging 2 start source	<i>Binary src</i>	-	-	1 = 1
20.28	Remote to local action	<i>List</i>	0...1	-	1 = 1
20.30	Enable signals warning function	<i>PB</i>	0000h...FFFFh	-	1 = 1
21 Start/stop mode					
21.01	Start mode	<i>List</i>	0...2	-	1 = 1

332 Additional parameter data

No.	Name	Type	Range	Unit	FbEq32
21.02	Magnetization time	<i>Real</i>	0...10000	ms	1 = 1 ms
21.03	Stop mode	<i>List</i>	0...2	-	1 = 1
21.04	Emergency stop mode	<i>List</i>	0...3	-	1 = 1
21.05	Emergency stop source	<i>Binary src</i>	-	-	1 = 1
21.06	Zero speed limit	<i>Real</i>	0.00...30000.00	rpm	100 = 1 rpm
21.07	Zero speed delay	<i>Real</i>	0...30000	ms	1 = 1 ms
21.08	DC current control	<i>PB</i>	0b0000...0b1111	-	1 = 1
21.09	DC hold speed	<i>Real</i>	0.00...1000.00	rpm	100 = 1 rpm
21.10	DC current reference	<i>Real</i>	0.0...100.0	%	10 = 1%
21.11	Post magnetization time	<i>Real</i>	0...3000	s	1 = 1 s
21.13	Autophasing mode	<i>List</i>	0...5	-	1 = 1
21.14	Pre-heating input source	<i>Binary src</i>	-	-	1 = 1
21.15	Pre-heating time delay	<i>Real</i>	10...3000	s	1 = 1 s
21.16	Pre-heating current	<i>Real</i>	0.0...30.0	%	10 = 1%
21.19	Scalar start mode	<i>List</i>	0...6	-	1 = 1
21.21	DC hold frequency	<i>Real</i>	0.00...1000.00	Hz	100 = 1 Hz
21.22	Start delay	<i>Real</i>	0.00...60.00	s	100 = 1 s
21.23	Smooth start	<i>Real</i>	0...2	-	1 = 1
21.24	Smooth start current	<i>Real</i>	10.0...100.0	%	100 = 1%
21.25	Smooth start speed	<i>Real</i>	2.0...100.0	%	100 = 1%
21.26	Torque boost current	<i>Real</i>	15.0...300.0	%	100 = 1%
21.27	Torque boost time	<i>Real</i>	0.0...60.0	%	100 = 1%
21.30	Speed compensated stop mode	<i>Real</i>	0...3	-	1 = 1
21.31	Speed comp stop delay	<i>Real</i>	0.00...1000.00	s	100 = 1 s
21.32	Speed comp stop threshold	<i>Real</i>	0...100	%	1 = 1%
22 Speed reference selection					
22.01	Speed ref unlimited	<i>Real</i>	-30000.00...30000.00	rpm	100 = 1 rpm
22.11	Ext1 speed ref1	<i>Analog src</i>	-	-	1 = 1
22.12	Ext1 speed ref2	<i>Analog src</i>	-	-	1 = 1
22.13	Ext1 speed function	<i>List</i>	0...6	-	1 = 1
22.18	Ext2 speed ref1	<i>Analog src</i>	-	-	1 = 1
22.19	Ext2 speed ref2	<i>Analog src</i>	-	-	1 = 1
22.20	Ext2 speed function	<i>List</i>	0...6	-	1 = 1
22.21	Constant speed function	<i>PB</i>	0b0000...0b1111	-	1 = 1
22.22	Constant speed sel1	<i>Binary src</i>	-	-	1 = 1
22.23	Constant speed sel2	<i>Binary src</i>	-	-	1 = 1
22.24	Constant speed sel3	<i>Binary src</i>	-	-	1 = 1
22.26	Constant speed 1	<i>Real</i>	-30000.00...30000.00	rpm	100 = 1 rpm
22.27	Constant speed 2	<i>Real</i>	-30000.00...30000.00	rpm	100 = 1 rpm
22.28	Constant speed 3	<i>Real</i>	-30000.00...30000.00	rpm	100 = 1 rpm

No.	Name	Type	Range	Unit	FbEq32
22.29	Constant speed 4	<i>Real</i>	-30000.00...30000.00	rpm	100 = 1 rpm
22.30	Constant speed 5	<i>Real</i>	-30000.00...30000.00	rpm	100 = 1 rpm
22.31	Constant speed 6	<i>Real</i>	-30000.00...30000.00	rpm	100 = 1 rpm
22.32	Constant speed 7	<i>Real</i>	-30000.00...30000.00	rpm	100 = 1 rpm
22.41	Speed ref safe	<i>Real</i>	-30000.00...30000.00	rpm	100 = 1 rpm
22.42	Jogging 1 ref	<i>Real</i>	-30000.00...30000.00	rpm	100 = 1 rpm
22.43	Jogging 2 ref	<i>Real</i>	-30000.00...30000.00	rpm	100 = 1 rpm
22.51	Critical speed function	<i>PB</i>	0000h...FFFFh	-	1 = 1
22.52	Critical speed 1 low	<i>Real</i>	-30000.00...30000.00	rpm	100 = 1 rpm
22.53	Critical speed 1 high	<i>Real</i>	-30000.00...30000.00	rpm	100 = 1 rpm
22.54	Critical speed 2 low	<i>Real</i>	-30000.00...30000.00	rpm	100 = 1 rpm
22.55	Critical speed 2 high	<i>Real</i>	-30000.00...30000.00	rpm	100 = 1 rpm
22.56	Critical speed 3 low	<i>Real</i>	-30000.00...30000.00	rpm	100 = 1 rpm
22.57	Critical speed 3 high	<i>Real</i>	-30000.00...30000.00	rpm	100 = 1 rpm
22.70	Motor potentiometer reference enable	<i>List</i>	0...2	-	1 = 1
22.71	Motor potentiometer function	<i>List</i>	0...3, 5	-	1 = 1
22.72	Motor potentiometer initial value	<i>Real</i>	-32768.00...32767.00	-	100 = 1
22.73	Motor potentiometer up source	<i>Binary src</i>	-	-	1 = 1
22.74	Motor potentiometer down source	<i>Binary src</i>	-	-	1 = 1
22.75	Motor potentiometer ramp time	<i>Real</i>	0.0...3600.0	s	10 = 1 s
22.76	Motor potentiometer min value	<i>Real</i>	-32768.00...32767.00	-	100 = 1
22.77	Motor potentiometer max value	<i>Real</i>	-32768.00...32767.00	-	100 = 1
22.80	Motor potentiometer ref act	<i>Real</i>	-32768.00...32767.00	-	100 = 1
22.86	Speed reference act 6	<i>Real</i>	-30000.00...30000.00	rpm	100 = 1 rpm
22.87	Speed reference act 7	<i>Real</i>	-30000.00...30000.00	rpm	100 = 1 rpm
23 Speed reference ramp					
23.01	Speed ref ramp input	<i>Real</i>	-30000.00...30000.00	rpm	100 = 1 rpm
23.02	Speed ref ramp output	<i>Real</i>	-30000.00...30000.00	rpm	100 = 1 rpm
23.11	Ramp set selection	<i>Binary src</i>	-	-	1 = 1
23.12	Acceleration time 1	<i>Real</i>	0.000 ...1800.000	s	1000 = 1 s
23.13	Deceleration time 1	<i>Real</i>	0.000 ...1800.000	s	1000 = 1 s
23.14	Acceleration time 2	<i>Real</i>	0.000 ...1800.000	s	1000 = 1 s
23.15	Deceleration time 2	<i>Real</i>	0.000 ...1800.000	s	1000 = 1 s
23.20	Acc time jogging	<i>Real</i>	0.000 ...1800.000	s	1000 = 1 s
23.21	Dec time jogging	<i>Real</i>	0.000 ...1800.000	s	1000 = 1 s

334 Additional parameter data

No.	Name	Type	Range	Unit	FbEq32
23.23	Emergency stop time	<i>Real</i>	0.000 ...1800.000	s	1000 = 1 s
23.28	Variable slope enable	<i>Real</i>	2...30000	ms	1 = 1 ms
23.29	Variable slope rate	<i>Real</i>	2...30000	ms	1 = 1 ms
23.32	Shape time 1	<i>Real</i>	0.000 ...1800.000	s	1000 = 1 s
23.33	Shape time 2	<i>Real</i>	0.000 ...1800.000	s	1000 = 1 s
24 Speed reference conditioning					
24.01	Used speed reference	<i>Real</i>	-30000.00...30000.00	rpm	100 = 1 rpm
24.02	Used speed feedback	<i>Real</i>	-30000.00...30000.00	rpm	100 = 1 rpm
24.03	Speed error filtered	<i>Real</i>	-30000.0...30000.0	rpm	100 = 1 rpm
24.04	Speed error inverted	<i>Real</i>	-30000.0...30000.0	rpm	100 = 1 rpm
24.11	Speed correction	<i>Real</i>	-10000.00...10000.00	rpm	100 = 1 rpm
24.12	Speed error filter time	<i>Real</i>	0...10000	ms	1 = 1 ms
25 Speed control					
25.01	Torque reference speed control	<i>Real</i>	-1600.0...1600.0	%	10 = 1%
25.02	Speed proportional gain	<i>Real</i>	0.00...250.00	-	100 = 1
25.03	Speed integration time	<i>Real</i>	0.00...1000.00	s	100 = 1 s
25.04	Speed derivation time	<i>Real</i>	0.000...10.000	s	1000 = 1 s
25.05	Derivation filter time	<i>Real</i>	0...10000	ms	1 = 1 ms
25.06	Acc comp derivation time	<i>Real</i>	0.00...1000.00	s	100 = 1 s
25.07	Acc comp filter time	<i>Real</i>	0.0...1000.0	ms	10 = 1 ms
25.15	Proportional gain em stop	<i>Real</i>	1.00...250.00	-	100 = 1
25.30	Flux adaptation enable	<i>List</i>	-	-	1 = 1
25.33	Speed controller autotune	<i>List</i>	-	-	1 = 1
25.34	Speed controller autotune mode	<i>List</i>	-	-	1 = 1
25.37	Mechanical time constant	<i>Real</i>	0.00...1000.00	-	100 = 1 s
25.38	Autotune torque step	<i>Real</i>	0.00...100.00	-	100 = 1%
25.39	Autotune speed step	<i>Real</i>	0.00...100.00	-	100 = 1%
25.40	Autotune repeat times	<i>Real</i>	1...10	-	1 = 1
25.53	Torque prop reference	<i>Real</i>	-30000.0...30000.0	%	10 = 1%
25.54	Torque integral reference	<i>Real</i>	-30000.0...30000.0	%	10 = 1%
25.55	Torque deriv reference	<i>Real</i>	-30000.0...30000.0	%	10 = 1%
25.56	Torque acc compensation	<i>Real</i>	-30000.0...30000.0	%	10 = 1%
26 Torque reference chain					
26.01	Torque reference to TC	<i>Real</i>	-1600.0...1600.0	%	10 = 1%
26.02	Torque reference used	<i>Real</i>	-1600.0...1600.0	%	10 = 1%
26.08	Minimum torque ref	<i>Real</i>	-1000.0...0.0	%	10 = 1%
26.09	Maximum torque ref	<i>Real</i>	0.0...1000.0	%	10 = 1%
26.11	Torque ref1 source	<i>Analog src</i>	-	-	1 = 1
26.12	Torque ref2 source	<i>Analog src</i>	-	-	1 = 1

No.	Name	Type	Range	Unit	FbEq32
26.13	Torque ref1 function	List	0..5	-	1 = 1
26.14	Torque ref1/2 selection	Binary src	-	-	1 = 1
26.17	Torque ref filter time	Real	0.000...30.000	s	1000 = 1 s
26.18	Torque ramp up time	Real	0.000...60.000	s	1000 = 1 s
26.19	Torque ramp down time	Real	0.000...60.000	s	1000 = 1 s
26.20	Torque reversal	List	-	-	1 = 1
26.70	Torque reference act 1	Real	-1600.0...1600.0	%	10 = 1%
26.71	Torque reference act 2	Real	-1600.0...1600.0	%	10 = 1%
26.72	Torque reference act 3	Real	-1600.0...1600.0	%	10 = 1%
26.73	Torque reference act 4	Real	-1600.0...1600.0	%	10 = 1%
26.74	Torque ref ramp out	Real	-1600.0...1600.0	%	10 = 1%
26.75	Torque reference act 5	Real	-1600.0...1600.0	%	10 = 1%
26.76	Torque reference act 6	Real	-1600.0...1600.0	%	10 = 1%
26.81	Rush control gain	Real	0.0 ... 10000.0	-	10 = 1
26.82	Rush control integration time	Real	0.0 ... 10.0	s	10 = 1 s
28 Frequency reference chain					
28.01	Frequency ref ramp input	Real	-500.00...500.00	Hz	100 = 1 Hz
28.02	Frequency ref ramp output	Real	-500.00...500.00	Hz	100 = 1 Hz
28.11	Ext1 frequency ref1	Analog src	-	-	1 = 1
28.12	Ext1 frequency ref2	Analog src	-	-	1 = 1
28.13	Ext1 frequency function	List	0..6	-	1 = 1
28.15	Ext2 frequency ref1	Analog src	-	-	1 = 1
28.16	Ext2 frequency ref2	Analog src	-	-	1 = 1
28.17	Ext2 frequency function	List	0..6	-	1 = 1
28.21	Constant frequency function	PB	0000h...FFFFh	-	1 = 1
28.22	Constant frequency sel1	Binary src	-	-	1 = 1
28.23	Constant frequency sel2	Binary src	-	-	1 = 1
28.24	Constant frequency sel3	Binary src	-	-	1 = 1
28.26	Constant frequency 1	Real	-500.00...500.00	Hz	100 = 1 Hz
28.27	Constant frequency 2	Real	-500.00...500.00	Hz	100 = 1 Hz
28.28	Constant frequency 3	Real	-500.00...500.00	Hz	100 = 1 Hz
28.29	Constant frequency 4	Real	-500.00...500.00	Hz	100 = 1 Hz
28.30	Constant frequency 5	Real	-500.00...500.00	Hz	100 = 1 Hz
28.31	Constant frequency 6	Real	-500.00...500.00	Hz	100 = 1 Hz
28.32	Constant frequency 7	Real	-500.00...500.00	Hz	100 = 1 Hz
28.41	Frequency ref safe	Real	-500.00...500.00	Hz	100 = 1 Hz
28.42	Jogging 1 frequency ref	Real	-500.00...500.00	Hz	100 = 1 Hz
28.43	Jogging 2 frequency ref	Real	-500.00...500.00	Hz	100 = 1 Hz
28.51	Critical frequency function	PB	00b...11b	-	1 = 1
28.52	Critical frequency 1 low	Real	-500.00...500.00	Hz	100 = 1 Hz

336 Additional parameter data

No.	Name	Type	Range	Unit	FbEq32
28.53	Critical frequency 1 high	<i>Real</i>	-500.00...500.00	Hz	100 = 1 Hz
28.54	Critical frequency 2 low	<i>Real</i>	-500.00...500.00	Hz	100 = 1 Hz
28.55	Critical frequency 2 high	<i>Real</i>	-500.00...500.00	Hz	100 = 1 Hz
28.56	Critical frequency 3 low	<i>Real</i>	-500.00...500.00	Hz	100 = 1 Hz
28.57	Critical frequency 3 high	<i>Real</i>	-500.00...500.00	Hz	100 = 1 Hz
28.71	Freq ramp set selection	<i>Binary src</i>	-	-	1 = 1
28.72	Freq acceleration time 1	<i>Real</i>	0.000...1800.000	s	1000 = 1 s
28.73	Freq deceleration time 1	<i>Real</i>	0.000...1800.000	s	1000 = 1 s
28.74	Freq acceleration time 2	<i>Real</i>	0.000...1800.000	s	1000 = 1 s
28.75	Freq deceleration time 2	<i>Real</i>	0.000...1800.000	s	1000 = 1 s
28.76	Freq ramp in zero source	<i>Binary src</i>	-	-	1 = 1
28.82	Shape time 1	<i>Real</i>	0.000...1800.000	s	1000 = 1 s
28.83	Shape time 2	<i>Real</i>	0.000...1800.000	s	1000 = 1 s
28.92	Frequency ref act 3	<i>Real</i>	-500.00...500.00	Hz	100 = 1 Hz
28.96	Frequency ref act 7	<i>Real</i>	-500.00...500.00	Hz	100 = 1 Hz
28.97	Frequency ref unlimited	<i>Real</i>	-500.00 ... 500.00	Hz	100 = 1 Hz
30 Limits					
30.01	Limit word 1	<i>PB</i>	0000h...FFFFh	-	1 = 1
30.02	Torque limit status	<i>PB</i>	0000h...FFFFh	-	1 = 1
30.11	Minimum speed	<i>Real</i>	-30000.00...30000.00	rpm	100 = 1 rpm
30.12	Maximum speed	<i>Real</i>	-30000.00...30000.00	rpm	100 = 1 rpm
30.13	Minimum frequency	<i>Real</i>	-500.00...500.00	Hz	100 = 1 Hz
30.14	Maximum frequency	<i>Real</i>	-500.00...500.00	Hz	100 = 1 Hz
30.17	Maximum current	<i>Real</i>	0.00...30000.00	A	100 = 1 A
30.18	Torq lim sel	<i>Binary src</i>	-	-	1 = 1
30.19	Minimum torque 1	<i>Real</i>	-1600.0...0.0	%	10 = 1%
30.20	Maximum torque 1	<i>Real</i>	0.0...1600.0	%	10 = 1%
30.21	Min torque 2 source	<i>Analog src</i>	-	-	1 = 1
30.22	Max torque 2 source	<i>Analog src</i>	-	-	1 = 1
30.23	Minimum torque 2	<i>Real</i>	-1600.0...0.0	%	10 = 1%
30.24	Maximum torque 2	<i>Real</i>	0.0...1600.0	%	10 = 1%
30.26	Power motoring limit	<i>Real</i>	0.00...600.00	%	100 = 1%
30.27	Power generating limit	<i>Real</i>	-600.00...0.00	%	100 = 1%
30.30	Overvoltage control	<i>List</i>	0...1	-	1 = 1
30.31	Undervoltage control	<i>List</i>	0...1	-	1 = 1
30.35	Thermal current limitation	<i>List</i>	0...1	-	1 = 1
30.36	Speed limit selection	<i>Binary src</i>	-	-	1 = 1
30.37	Min speed source	<i>Analog src</i>	-	-	1 = 1
30.38	Max speed source	<i>Analog src</i>	-	-	1 = 1
31 Fault functions					
31.01	External event 1 source	<i>Binary src</i>	-	-	1 = 1

No.	Name	Type	Range	Unit	FbEq32
31.02	External event 1 type	List	0..1	-	1 = 1
31.03	External event 2 source	Binary src	-	-	1 = 1
31.04	External event 2 type	List	0..1	-	1 = 1
31.05	External event 3 source	Binary src	-	-	1 = 1
31.06	External event 3 type	List	0..1	-	1 = 1
31.07	External event 4 source	Binary src	-	-	1 = 1
31.08	External event 4 type	List	0..1	-	1 = 1
31.09	External event 5 source	Binary src	-	-	1 = 1
31.10	External event 5 type	List	0..1	-	1 = 1
31.11	Fault reset selection	Binary src	-	-	1 = 1
31.12	Autoreset selection	PB	0000h...FFFFh	-	1 = 1
31.13	Selectable fault	Real	0000h...FFFFh	-	1 = 1
31.14	Number of trials	Real	0..5	-	1 = 1
31.15	Total trials time	Real	1.0...600.0	s	10 = 1 s
31.16	Delay time	Real	0.0...120.0	s	10 = 1 s
31.19	Motor phase loss	List	0..1	-	1 = 1
31.20	Earth fault	List	0..2	-	1 = 1
31.21	Supply phase loss	List	0..1	-	1 = 1
31.22	STO indication run/stop	List	0..5	-	1 = 1
31.23	Wiring or earth fault	List	0..1	-	1 = 1
31.24	Stall function	List	0..2	-	1 = 1
31.25	Stall current limit	Real	0.0...1600.0	%	10 = 1%
31.26	Stall speed limit	Real	0.00...10000.00	rpm	100 = 1 rpm
31.27	Stall frequency limit	Real	0.00...1000.00	Hz	100 = 1 Hz
31.28	Stall time	Real	0...3600	s	1 = 1 s
31.30	Overspeed trip margin	Real	0.00...10000.00	rpm	100 = 1 rpm
31.31	Frequency trip margin	Real	0.00...10000.00	Hz	100 = 1 Hz
31.32	Emergency ramp supervision	Real	0...300	%	1 = 1%
31.33	Emergency ramp supervision delay	Real	0...100	s	1 = 1 s
31.40	Disable warning messages	List	0..2	-	1 = 1
31.54	Fault action	List	0..2	-	1 = 1
32 Supervision					
32.01	Supervision status	PB	0000h...FFFFh	-	1 = 1
32.05	Supervision 1 function	List	0..9	-	1 = 1
32.06	Supervision 1 action	List	0..2	-	1 = 1
32.07	Supervision 1 signal	Analog src	-	-	1 = 1
32.08	Supervision 1 filter time	Real	0.000...30.000	s	1000 = 1 s
32.09	Supervision 1 low	Real	-21474830.00... 21474830.00	-	100 = 1

338 Additional parameter data

No.	Name	Type	Range	Unit	FbEq32
32.10	Supervision 1 high	<i>Real</i>	-21474830.00... 21474830.00	-	100 = 1
32.11	Supervision 1 hysteresis	<i>Real</i>	0.00...100000.00	-	100 = 1
32.15	Supervision 2 function	<i>List</i>	0...9	-	1 = 1
32.16	Supervision 2 action	<i>List</i>	0...2	-	1 = 1
32.17	Supervision 2 signal	<i>Analog src</i>	-	-	1 = 1
32.18	Supervision 2 filter time	<i>Real</i>	0.000...30.000	s	1000 = 1 s
32.19	Supervision 2 low	<i>Real</i>	-21474830.00... 21474830.00	-	100 = 1
32.20	Supervision 2 high	<i>Real</i>	-21474830.00... 21474830.00	-	100 = 1
32.21	Supervision 2 hysteresis	<i>Real</i>	0.00...100000.00	-	100 = 1
32.25	Supervision 3 function	<i>List</i>	0...9	-	1 = 1
32.26	Supervision 3 action	<i>List</i>	0...2	-	1 = 1
32.27	Supervision 3 signal	<i>Analog src</i>	-	-	1 = 1
32.28	Supervision 3 filter time	<i>Real</i>	0.000...30.000	s	1000 = 1 s
32.29	Supervision 3 low	<i>Real</i>	-21474830.00... 21474830.00	-	100 = 1
32.30	Supervision 3 high	<i>Real</i>	-21474830.00... 21474830.00	-	100 = 1
32.31	Supervision 3 hysteresis	<i>Real</i>	0.00...100000.00	-	100 = 1
32.35	Supervision 4 function	<i>List</i>	0...9	-	1 = 1
32.36	Supervision 4 action	<i>List</i>	0...2	-	1 = 1
32.37	Supervision 4 signal	<i>Analog src</i>	-	-	1 = 1
32.38	Supervision 4 filter time	<i>Real</i>	0.000...30.000	s	1000 = 1 s
32.39	Supervision 4 low	<i>Real</i>	-21474830.00... 21474830.00	-	100 = 1
32.40	Supervision 4 high	<i>Real</i>	-21474830.00... 21474830.00	-	100 = 1
32.41	Supervision 4 hysteresis	<i>Real</i>	0.00...100000.00	-	100 = 1
32.45	Supervision 5 function	<i>List</i>	0...9	-	1 = 1
32.46	Supervision 5 action	<i>List</i>	0...2	-	1 = 1
32.47	Supervision 5 signal	<i>Analog src</i>	-	-	1 = 1
32.48	Supervision 5 filter time	<i>Real</i>	0.000...30.000	s	1000 = 1 s
32.49	Supervision 5 low	<i>Real</i>	-21474830.00... 21474830.00	-	100 = 1
32.50	Supervision 5 high	<i>Real</i>	-21474830.00... 21474830.00	-	100 = 1
32.51	Supervision 5 hysteresis	<i>Real</i>	0.00...100000.00	-	100 = 1
32.55	Supervision 6 function	<i>List</i>	0...9	-	1 = 1
32.56	Supervision 6 action	<i>List</i>	0...2	-	1 = 1
32.57	Supervision 6 signal	<i>Analog src</i>	-	-	1 = 1
32.58	Supervision 6 filter time	<i>Real</i>	0.000...30.000	s	1000 = 1 s

No.	Name	Type	Range	Unit	FbEq32
32.59	Supervision 6 low	<i>Real</i>	-21474830.00... 21474830.00	-	100 = 1
32.60	Supervision 6 high	<i>Real</i>	-21474830.00... 21474830.00	-	100 = 1
32.61	Supervision 6 hysteresis	<i>Real</i>	0.00...100000.00	-	100 = 1
35 Motor thermal protection					
35.01	Motor estimated temperature	<i>Real</i>	-60...1000 °C	°C or °F	1 = 1°
35.02	Measured temperature 1	<i>Real</i>	-60...5000 °C	°C, °F or ohm	1 = 1 unit
35.05	Motor overload level	<i>Real</i>	0.0...300.0%	%	10 = 1%
35.11	Temperature 1 source	<i>List</i>	0...2, 5...7, 11...16	-	1 = 1
35.12	Temperature 1 fault limit	<i>Real</i>	-60 ... 5000 °C	°C, °F or ohm	1 = 1 unit
35.13	Temperature 1 warning limit	<i>Real</i>	-60 ... 5000 °C	°C, °F or ohm	1 = 1 unit
35.14	Temperature 1 AI source	<i>Analog src</i>	-	-	1 = 1
35.50	Motor ambient temperature	<i>Real</i>	-60...100 °C or -75 ... 212 °F	°C or °F	1 = 1°
35.51	Motor load curve	<i>Real</i>	50...150	%	1 = 1%
35.52	Zero speed load	<i>Real</i>	25...150	%	1 = 1%
35.53	Break point	<i>Real</i>	1.00 ... 500.00	Hz	100 = 1 Hz
35.54	Motor nominal temperature rise	<i>Real</i>	0...300 °C	°C or °F	1 = 1°
35.55	Motor thermal time constant	<i>Real</i>	100...10000	s	1 = 1 s
35.56	Motor overload action	<i>List</i>	-	-	10 = 1
35.57	Motor overload class	<i>List</i>	-	-	10 = 1
36 Load analyzer					
36.01	PVL signal source	<i>Analog src</i>	-	-	1 = 1
36.02	PVL filter time	<i>Real</i>	0.00...120.00	s	100 = 1 s
36.06	AL2 signal source	<i>Analog src</i>	-	-	1 = 1
36.07	AL2 signal scaling	<i>Real</i>	0.00...32767.00	-	100 = 1
36.09	Reset loggers	<i>List</i>	0...3	-	1 = 1
36.10	PVL peak value	<i>Real</i>	-32768.00...32767.00	-	100 = 1
36.11	PVL peak date	<i>Data</i>	1/1/1980...6/5/2159	-	1 = 1
36.12	PVL peak time	<i>Data</i>	-	-	1 = 1
36.13	PVL current at peak	<i>Real</i>	-32768.00...32767.00	A	100 = 1 A
36.14	PVL DC voltage at peak	<i>Real</i>	0.00...2000.00	V	100 = 1 V
36.15	PVL speed at peak	<i>Real</i>	-30000... 30000	rpm	100 = 1 rpm
36.16	PVL reset date	<i>Data</i>	1/1/1980...6/5/2159	-	1 = 1
36.17	PVL reset time	<i>Data</i>	-	-	1 = 1
36.20	AL1 0 to 10%	<i>Real</i>	0.00...100.00	%	100 = 1%
36.21	AL1 10 to 20%	<i>Real</i>	0.00...100.00	%	100 = 1%

340 Additional parameter data

No.	Name	Type	Range	Unit	FbEq32
36.22	AL1 20 to 30%	<i>Real</i>	0.00...100.00	%	100 = 1%
36.23	AL1 30 to 40%	<i>Real</i>	0.00...100.00	%	100 = 1%
36.24	AL1 40 to 50%	<i>Real</i>	0.00...100.00	%	100 = 1%
36.25	AL1 50 to 60%	<i>Real</i>	0.00...100.00	%	100 = 1%
36.26	AL1 60 to 70%	<i>Real</i>	0.00...100.00	%	100 = 1%
36.27	AL1 70 to 80%	<i>Real</i>	0.00...100.00	%	100 = 1%
36.28	AL1 80 to 90%	<i>Real</i>	0.00...100.00	%	100 = 1%
36.29	AL1 over 90%	<i>Real</i>	0.00...100.00	%	100 = 1%
36.40	AL2 0 to 10%	<i>Real</i>	0.00...100.00	%	100 = 1%
36.41	AL2 10 to 20%	<i>Real</i>	0.00...100.00	%	100 = 1%
36.42	AL2 20 to 30%	<i>Real</i>	0.00...100.00	%	100 = 1%
36.43	AL2 30 to 40%	<i>Real</i>	0.00...100.00	%	100 = 1%
36.44	AL2 40 to 50%	<i>Real</i>	0.00...100.00	%	100 = 1%
36.45	AL2 50 to 60%	<i>Real</i>	0.00...100.00	%	100 = 1%
36.46	AL2 60 to 70%	<i>Real</i>	0.00...100.00	%	100 = 1%
36.47	AL2 70 to 80%	<i>Real</i>	0.00...100.00	%	100 = 1%
36.48	AL2 80 to 90%	<i>Real</i>	0.00...100.00	%	100 = 1%
36.49	AL2 over 90%	<i>Real</i>	0.00...100.00	%	100 = 1%
36.50	AL2 reset date	<i>Data</i>	1/1/1980..6/5/2159	-	1 = 1
36.51	AL2 reset time	<i>Data</i>	-	-	1 = 1
37 User load curve					
37.01	ULC output status word	<i>PB</i>	0000h...FFFFh	-	1 = 1
37.02	ULC supervision signal	<i>Analog src</i>	-	-	1 = 1
37.03	ULC overload actions	<i>List</i>	0...3	-	1 = 1
37.04	ULC underload actions	<i>List</i>	0...3	-	1 = 1
37.11	ULC speed table point 1	<i>Real</i>	-30000.0...30000.0	rpm	10 = 1 rpm
37.12	ULC speed table point 2	<i>Real</i>	-30000.0...30000.0	rpm	10 = 1 rpm
37.13	ULC speed table point 3	<i>Real</i>	-30000.0...30000.0	rpm	10 = 1 rpm
37.14	ULC speed table point 4	<i>Real</i>	-30000.0...30000.0	rpm	10 = 1 rpm
37.15	ULC speed table point 5	<i>Real</i>	-30000.0...30000.0	rpm	10 = 1 rpm
37.16	ULC frequency table point 1	<i>Real</i>	-500.0...500.0	Hz	10 = 1 Hz
37.17	ULC frequency table point 2	<i>Real</i>	-500.0...500.0	Hz	10 = 1 Hz
37.18	ULC frequency table point 3	<i>Real</i>	-500.0...500.0	Hz	10 = 1 Hz
37.19	ULC frequency table point 4	<i>Real</i>	-500.0...500.0	Hz	10 = 1 Hz
37.20	ULC frequency table point 5	<i>Real</i>	-500.0...500.0	Hz	10 = 1 Hz
37.21	ULC underload point 1	<i>Real</i>	-1600.0...1600.0	%	10 = 1%
37.22	ULC underload point 2	<i>Real</i>	-1600.0...1600.0	%	10 = 1%
37.23	ULC underload point 3	<i>Real</i>	-1600.0...1600.0	%	10 = 1%
37.24	ULC underload point 4	<i>Real</i>	-1600.0...1600.0	%	10 = 1%
37.25	ULC underload point 5	<i>Real</i>	-1600.0...1600.0	%	10 = 1%
37.31	ULC overload point 1	<i>Real</i>	-1600.0...1600.0	%	10 = 1%

No.	Name	Type	Range	Unit	FbEq32
37.32	ULC overload point 2	<i>Real</i>	-1600.0...1600.0	%	10 = 1%
37.33	ULC overload point 3	<i>Real</i>	-1600.0...1600.0	%	10 = 1%
37.34	ULC overload point 4	<i>Real</i>	-1600.0...1600.0	%	10 = 1%
37.35	ULC overload point 5	<i>Real</i>	-1600.0...1600.0	%	10 = 1%
37.41	ULC overload timer	<i>Real</i>	0.0...10000.0	s	10 = 1 s
37.42	ULC underload timer	<i>Real</i>	0.0...10000.0	s	10 = 1 s
40 Process PID set 1					
40.01	Process PID output actual	<i>Real</i>	-200000.00...200000.00	%	100 = 1%
40.02	Process PID feedback actual	<i>Real</i>	-200000.00...200000.00	PID customer units	100 = 1 PID customer unit
40.03	Process PID setpoint actual	<i>Real</i>	-200000.00...200000.00	PID customer units	100 = 1 PID customer unit
40.04	Process PID deviation actual	<i>Real</i>	-200000.00...200000.00	PID customer units	100 = 1 PID customer unit
40.05	Process PID trim output act	<i>Real</i>	-200000.00...200000.00	PID customer units	100 = 1 PID customer unit
40.06	Process PID status word	<i>PB</i>	0000h...FFFFh	-	1 = 1
40.07	Process PID operation mode	<i>List</i>	0...2	-	1 = 1
40.08	Set 1 feedback 1 source	<i>Analog src</i>	-	-	1 = 1
40.09	Set 1 feedback 2 source	<i>Analog src</i>	-	-	1 = 1
40.10	Set 1 feedback function	<i>List</i>	0...11	-	1 = 1
40.11	Set 1 feedback filter time	<i>Real</i>	0.000...30.000	s	1000 = 1 s
40.14	Set 1 setpoint scaling	<i>Real</i>	-200000.00...200000.00	-	100 = 1
40.15	Set 1 output scaling	<i>Real</i>	-200000.00...200000.00	-	100 = 1
40.16	Set 1 setpoint 1 source	<i>Analog src</i>	-	-	1 = 1
40.17	Set 1 setpoint 2 source	<i>Analog src</i>	-	-	1 = 1
40.18	Set 1 setpoint function	<i>List</i>	0...11	-	1 = 1
40.19	Set 1 internal setpoint sel1	<i>Binary src</i>	-	-	1 = 1
40.20	Set 1 internal setpoint sel2	<i>Binary src</i>	-	-	1 = 1
40.21	Set 1 internal setpoint 1	<i>Real</i>	-200000.00...200000.00	PID customer units	100 = 1 PID customer unit
40.22	Set 1 internal setpoint 2	<i>Real</i>	-200000.00...200000.00	PID customer units	100 = 1 PID customer unit
40.23	Set 1 internal setpoint 3	<i>Real</i>	-200000.00...200000.00	PID customer units	100 = 1 PID customer unit
40.24	Set 1 internal setpoint 0	<i>Real</i>	-200000.00...200000.00	PID customer units	100 = 1 PID customer unit

342 Additional parameter data

No.	Name	Type	Range	Unit	FbEq32
40.26	Set 1 setpoint min	<i>Real</i>	-200000.00...200000.00	-	100 = 1
40.27	Set 1 setpoint max	<i>Real</i>	-200000.00...200000.00	-	100 = 1
40.28	Set 1 setpoint increase time	<i>Real</i>	0.0...1800.0	s	10 = 1 s
40.29	Set 1 setpoint decrease time	<i>Real</i>	0.0...1800.0	s	10 = 1 s
40.30	Set 1 setpoint freeze enable	<i>Binary src</i>	-	-	1 = 1
40.31	Set 1 deviation inversion	<i>Binary src</i>	-	-	1 = 1
40.32	Set 1 gain	<i>Real</i>	0.10...100.00	-	100 = 1
40.33	Set 1 integration time	<i>Real</i>	0.0...9999.0	s	10 = 1 s
40.34	Set 1 derivation time	<i>Real</i>	0.000...10.000	s	1000 = 1 s
40.35	Set 1 derivation filter time	<i>Real</i>	0.0...10.0	s	10 = 1 s
40.36	Set 1 output min	<i>Real</i>	-200000.00...200000.00	-	10 = 1
40.37	Set 1 output max	<i>Real</i>	-200000.00...200000.00	-	10 = 1
40.38	Set 1 output freeze enable	<i>Binary src</i>	-	-	1 = 1
40.39	Set 1 deadband range	<i>Real</i>	0.....200000.0	-	10 = 1
40.40	Set 1 deadband delay	<i>Real</i>	0.0 ... 3600.0	s	10 = 1 s
40.43	Set 1 sleep level	<i>Real</i>	0.....200000.0	-	10 = 1
40.44	Set 1 sleep delay	<i>Real</i>	0.0...3600.0	s	10 = 1 s
40.45	Set 1 sleep boost time	<i>Real</i>	0.0...3600.0	s	10 = 1 s
40.46	Set 1 sleep boost step	<i>Real</i>	-0.....200000.0	PID customer units	100 = 1 PID customer unit
40.47	Set 1 wake-up deviation	<i>Real</i>	-200000.00...200000.00	PID customer units	100 = 1 PID customer unit
40.48	Set 1 wake-up delay	<i>Real</i>	0.00...60.00	s	100 = 1 s
40.49	Set 1 tracking mode	<i>Binary src</i>	-	-	1 = 1
40.50	Set 1 tracking ref selection	<i>Analog src</i>	-	-	1 = 1
40.51	Set 1 trim mode	<i>List</i>	0...3	-	1 = 1
40.52	Set 1 trim selection	<i>List</i>	1...3	-	1 = 1
40.53	Set 1 trimmed ref pointer	<i>Binary src</i>	-	-	1 = 1
40.54	Set 1 trim mix	<i>Real</i>	0.000 ... 1.000	-	1000 = 1
40.55	Set 1 trim adjust	<i>Real</i>	-100.000 ... 100.000	-	1000 = 1
40.56	Set 1 trim source	<i>List</i>	1...2	-	1 = 1
40.57	PID set1/set2 selection	<i>Binary src</i>	-	-	1 = 1
40.58	Set 1 increase prevention	<i>List</i>	0...1	-	1 = 1
40.59	Set 1 decrease prevention	<i>List</i>	0...1	-	1 = 1
40.60	Set 1 PID activation source	<i>Binary src</i>	-	-	1 = 1
40.61	Setpoint scaling actual	<i>Real</i>	-200000.00...200000.00	-	100 = 1
40.62	PID internal setpoint actual	<i>Real</i>	-200000.00...200000.00	PID customer units	100 = 1 PID customer unit
40.65	Trim auto connection	<i>List</i>	0...1	-	1 = 1

No.	Name	Type	Range	Unit	FbEq32
40.79	Set 1 units	List	-	-	1 = 1
40.80	Set 1 PID output min source	Analog src	-	-	1 = 1
40.81	Set 1 PID output max source	Analog src	-	-	1 = 1
40.89	Set 1 setpoint multiplier	Real	-200000.00...200000.00	-	100 = 1
40.90	Set 1 feedback multiplier	Real	--200000.00...200000.00	-	100 = 1
40.91	Feedback data storage	Real	-327.68 ... 327.67	-	100 = 1
40.92	Setpoint data storage	Real	-327.68 ... 327.67	-	100 = 1
40.96	Process PID output %	Real	-100.00...100.00	%	100 = 1
40.97	Process PID feedback %	Real	-100.00...100.00	%	100 = 1
40.98	Process PID setpoint %	Real	-100.00...100.00	%	100 = 1
40.99	Process PID deviation %	Real	-100.00...100.00	%	100 = 1
41 Process PID set 2					
41.08	Set 2 feedback 1 source	Analog src	-	-	1 = 1
41.09	Set 2 feedback 2 source	Analog src	-	-	1 = 1
41.10	Set 2 feedback function	List	0...11	-	1 = 1
41.11	Set 2 feedback filter time	Real	0.000...30.000	s	1000 = 1 s
41.14	Set 2 setpoint scaling	Real	-200000.00...200000.00	-	100 = 1
41.15	Set 2 output scaling	Real	-200000.00...200000.00	-	100 = 1
41.16	Set 2 setpoint 1 source	Analog src	-	-	1 = 1
41.17	Set 2 setpoint 2 source	Analog src	-	-	1 = 1
41.18	Set 2 setpoint function	List	0...11	-	1 = 1
41.19	Set 2 internal setpoint sel1	Binary src	-	-	1 = 1
41.20	Set 2 internal setpoint sel2	Binary src	-	-	1 = 1
41.21	Set 2 internal setpoint 1	Real	-200000.00...200000.00	PID customer units	100 = 1 PID customer unit
41.22	Set 2 internal setpoint 2	Real	-200000.00...200000.00	PID customer units	100 = 1 PID customer unit
41.23	Set 2 internal setpoint 3	Real	-200000.00...200000.00	PID customer units	100 = 1 PID customer unit
41.24	Set 2 internal setpoint 0	Real	-200000.00...200000.00	PID customer units	100 = 1 PID customer unit
41.26	Set 2 setpoint min	Real	-200000.00...200000.00	-	100 = 1
41.27	Set 2 setpoint max	Real	-200000.00...200000.00	-	100 = 1
41.28	Set 2 setpoint increase time	Real	0.0...1800.0	s	10 = 1 s
41.29	Set 2 setpoint decrease time	Real	0.0...1800.0	s	10 = 1 s
41.30	Set 2 setpoint freeze enable	Binary src	-	-	1 = 1
41.31	Set 2 deviation inversion	Binary src	-	-	1 = 1
41.32	Set 2 gain	Real	0.01...100.00	-	100 = 1

344 Additional parameter data

No.	Name	Type	Range	Unit	FbEq32
41.33	Set 2 integration time	<i>Real</i>	0.0...9999.0	s	10 = 1 s
41.34	Set 2 derivation time	<i>Real</i>	0.000...10.000	s	1000 = 1 s
41.35	Set 2 derivation filter time	<i>Real</i>	0.0...10.0	s	10 = 1 s
41.36	Set 2 output min	<i>Real</i>	-200000.00... 200000.00	-	10 = 1
41.37	Set 2 output max	<i>Real</i>	-200000.00... 200000.00	-	10 = 1
41.38	Set 2 output freeze enable	<i>Binary src</i>	-	-	1 = 1
41.39	Set 2 deadband range	<i>Real</i>	0.....200000.0	-	10 = 1
41.40	Set 2 deadband delay	<i>Real</i>	0.0 ... 3600.0	s	10 = 1 s
41.43	Set 2 sleep level	<i>Real</i>	0.0...20000.00	-	10 = 1
41.44	Set 2 sleep delay	<i>Real</i>	0.0...3600.0	s	10 = 1 s
41.45	Set 2 sleep boost time	<i>Real</i>	0.0...3600.0	s	10 = 1 s
41.46	Set 2 sleep boost step	<i>Real</i>	0.0...20000.00	PID customer units	100 = 1 PID customer unit
41.47	Set 2 wake-up deviation	<i>Real</i>	-200000.00... 200000.00	PID customer units	100 = 1 PID customer unit
41.48	Set 2 wake-up delay	<i>Real</i>	0.00...60.00	s	100 = 1 s
41.49	Set 2 tracking mode	<i>Binary src</i>	-	-	1 = 1
41.50	Set 2 tracking ref selection	<i>Analog src</i>	-	-	1 = 1
41.51	Set 2 trim mode	<i>List</i>	0...3	-	1 = 1
41.52	Set 2 trim selection	<i>List</i>	1...3	-	1 = 1
41.53	Set 2 trimmed ref pointer	<i>Analog src</i>	-	-	1 = 1
41.54	Set 2 trim mix	<i>Real</i>	0.000...1.000	-	1 = 1
41.55	Set 2 trim adjust	<i>Real</i>	-100.000...100.000	-	1 = 1
41.56	Set 2 trim source	<i>List</i>	1...2	-	1 = 1
41.58	Set 2 increase prevention	<i>List</i>	0...3	-	1 = 1
41.59	Set 2 decrease prevention	<i>List</i>	0...3	-	1 = 1
41.60	Set 2 PID activation source	<i>Binary src</i>	-	-	1 = 1
41.79	Set 2 units	<i>List</i>	-	-	1 = 1
41.80	Set 2 PID output min source	<i>List</i>	0...1	-	1 = 1
41.81	Set 2 PID output max source	<i>List</i>	0...1	-	1 = 1
41.89	Set 2 setpoint multiplier	<i>Real</i>	-200000.00...200000.00	-	100 = 1
41.90	Set 2 feedback multiplier	<i>Real</i>	-200000.00...200000.00	-	100 = 1
43 Brake chopper					
43.01	Braking resistor temperature	<i>Real</i>	0.0...120.0	%	10 = 1%
43.06	Brake chopper enable	<i>List</i>	0...2	-	1 = 1
43.07	Brake chopper runtime enable	<i>Binary src</i>	-	-	1 = 1
43.08	Brake resistor thermal tc	<i>Real</i>	0...10000	s	1 = 1 s
43.09	Brake resistor Pmax cont	<i>Real</i>	0.00...10000.00	kW	100 = 1 kW
43.10	Brake resistance	<i>Real</i>	0.0...1000.0	ohm	10 = 1 ohm

No.	Name	Type	Range	Unit	FbEq32
43.11	Brake resistor fault limit	<i>Real</i>	0...150	%	1 = 1%
43.12	Brake resistor warning limit	<i>Real</i>	0...150	%	1 = 1%
44 Mechanical brake control					
44.01	Brake control status	<i>PB</i>	0000h...FFFFh	-	1 = 1
44.06	Brake control enable	<i>Binary src</i>	-	-	1 = 1
44.08	Brake open delay	<i>Real</i>	0.00...5.00	s	100 = 1 s
44.13	Brake close delay	<i>Real</i>	0.00...60.00	s	100 = 1 s
44.14	Brake close level	<i>Real</i>	0.0...1000.0	rpm	100 = 1 rpm
44.202	Torque proving	<i>Binary src</i>	-	-	1 = 1
44.203	Torque proving reference	<i>Real</i>	0.0...300.0	%	10 = 1.0%
44.204	Brake system check time	<i>Real</i>	0.10...30	ms	10 = 1 s
44.205	Brake slip speed limit	<i>Real</i>	0.0 ... 30000.0	rpm	1 = 1 rpm
44.206	Brake slip fault delay	<i>Real</i>	0...30000	ms	1 = 1 ms
44.207	Safety close select	<i>Binary src</i>	-	-	1 = 1
44.208	Safety close speed	<i>Real</i>	0.00 ... 30000.00	rpm	1 = 1 rpm
44.209	Safety close delay	<i>Real</i>	0...30000	ms	1 = 1 ms
44.211	Extended runtime	<i>Real</i>	0.0...3600.0	s	1000 = 1 s
44.212	Extended runtime sw	<i>Binary src</i>	0000h...FFFFh	-	-
45 Energy efficiency					
45.01	Saved GW hours	<i>Real</i>	0...65535	GWh	1 = 1 GWh
45.02	Saved MW hours	<i>Real</i>	0...999	MWh	1 = 1 MWh
45.03	Saved kW hours	<i>Real</i>	0.0...999.0	kWh	10 = 1 kWh
45.04	Saved energy	<i>Real</i>	0.0...214748364.7	kWh	10 = 1 kWh
45.05	Saved money x1000	<i>Real</i>	0...4294967295 thousands	(selectable)	1 = 1 unit
45.06	Saved money	<i>Real</i>	0.00...999.99	(selectable)	100 = 1 unit
45.07	Saved amount	<i>Real</i>	0.00...21474836.47	(selectable)	100 = 1 unit
45.08	CO2 reduction in kilotons	<i>Real</i>	0...65535	metric kiloton	1 = 1 metric kiloton
45.09	CO2 reduction in tons	<i>Real</i>	0.0...999.9	metric ton	10 = 1 metric ton
45.10	Total saved CO2	<i>Real</i>	0.0...214748365.7	metric ton	10 = 1 metric ton
45.11	Energy optimizer	<i>List</i>	0...1	-	1 = 1
45.12	Energy tariff 1	<i>Real</i>	0.000...4294967.295	(selectable)	1000 = 1 unit
45.13	Energy tariff 2	<i>Real</i>	0.000...4294967.295	(selectable)	1000 = 1 unit
45.14	Tariff selection	<i>Binary src</i>	-	-	1 = 1
45.18	CO2 conversion factor	<i>Real</i>	0.000...65.535	metric ton/ MWh	1000 = 1 metric ton/MWh

346 Additional parameter data

No.	Name	Type	Range	Unit	FbEq32
45.19	Comparison power	<i>Real</i>	0.00...100000.00	kW	10 = 1 kW
45.21	Energy calculations reset	<i>List</i>	0...1	-	1 = 1
45.24	Hourly peak power value	<i>Real</i>	-3000.00 ... 3000.00	kW	1 = 1 kW
45.25	Hourly peak power time	<i>Real</i>			N/A
45.26	Hourly total energy (resettable)	<i>Real</i>	-3000.00 ... 3000.00	kWh	1 = 1 kWh
45.27	Daily peak power value (resettable)	<i>Real</i>	-3000.00 ... 3000.00	kW	1 = 1 kW
45.28	Daily peak power time	<i>Real</i>			N/A
45.29	Daily total energy (resettable)	<i>Real</i>	-30000.00 ... 30000.00	kWh	1 = 1 kWh
45.30	Last day total energy	<i>Real</i>	-30000.00 ... 30000.00	kWh	1 = 1 kWh
45.31	Monthly peak power value (resettable)	<i>Real</i>	-3000.00 ... 3000.00	kW	1 = 1 kW
45.32	Monthly peak power date	<i>Real</i>	1/1/1980..6/5/2159		N/A
45.33	Monthly peak power time	<i>Real</i>			N/A
45.34	Monthly total energy (resettable)	<i>Real</i>	-1000000.00 ... 1000000.00	kWh	1 = 1 kWh
45.35	Last month total energy	<i>Real</i>	-1000000.00 ... 1000000.00	kWh	1 = 1 kWh
45.36	Lifetime peak power value	<i>Real</i>	-3000.00 ... 3000.00	kW	1 = 1 kW
45.37	Lifetime peak power date	<i>Real</i>			N/A
45.38	Lifetime peak power time	<i>Real</i>			N/A
46 Monitoring/scaling settings					
46.01	Speed scaling	<i>Real</i>	0.00...30000.00	rpm	100 = 1 rpm
46.02	Frequency scaling	<i>Real</i>	0.10...1000.00	Hz	100 = 1 Hz
46.03	Torque scaling	<i>Real</i>	0.1...1000.0	%	10 = 1%
46.04	Power scaling	<i>Real</i>	0.10...30000.00	-	10 = 1 unit
46.05	Current scaling	<i>Real</i>	0...30000	A	1 = 1 A
46.06	Speed ref zero scaling	<i>Real</i>	0.00 ... 30000.00	rpm	100 = 1 rpm
46.07	Frequency ref zero scaling	<i>Real</i>	0.00 ... 1000.00	Hz	100 = 1 Hz
46.11	Filter time motor speed	<i>Real</i>	2...20000	ms	1 = 1 ms
46.12	Filter time output frequency	<i>Real</i>	2...20000	ms	1 = 1 ms
46.13	Filter time motor torque	<i>Real</i>	2...20000	ms	1 = 1 ms
46.14	Filter time power	<i>Real</i>	2...20000	ms	1 = 1 ms
46.21	At speed hysteresis	<i>Real</i>	0.00...30000.00	rpm	100 = 1 rpm
46.22	At frequency hysteresis	<i>Real</i>	0.00...1000.00	Hz	100 = 1 Hz
46.23	At torque hysteresis	<i>Real</i>	0.00...300.00	%	1 = 1%
46.31	Above speed limit	<i>Real</i>	0.00...30000.00	rpm	100 = 1 rpm
46.32	Above frequency limit	<i>Real</i>	0.00...1000.00	Hz	100 = 1 Hz
46.33	Above torque limit	<i>Real</i>	0.0...1600.0	%	10 = 1%
46.41	kWh pulse scaling	<i>Real</i>	0.001...1000.000	kWh	1000 = 1 kWh
46.43	Power decimals	<i>Real</i>	0...3	-	1 = 1

No.	Name	Type	Range	Unit	FbEq32
46.44	Current decimals	<i>Real</i>	0...3	-	1 = 1
47 Data storage					
47.01	Data storage 1 real32	<i>Real</i>	-2147483.008... 2147483.008	-	1000 = 1
47.02	Data storage 2 real32	<i>Real</i>	-2147483.008... 2147483.008	-	1000 = 1
47.03	Data storage 3 real32	<i>Real</i>	-2147483.008... 2147483.008	-	1000 = 1
47.04	Data storage 4 real32	<i>Real</i>	-2147483.008... 2147483.008	-	1000 = 1
47.11	Data storage 1 int32	<i>Real</i>	-2147483648... 2147483647	-	1 = 1
47.12	Data storage 2 int32	<i>Real</i>	-2147483648... 2147483647	-	1 = 1
47.13	Data storage 3 int32	<i>Real</i>	-2147483648... 2147483647	-	1 = 1
47.14	Data storage 4 int32	<i>Real</i>	-2147483648... 2147483647	-	1 = 1
47.21	Data storage 1 int16	<i>Real</i>	-32768...32767	-	1 = 1
47.22	Data storage 2 int16	<i>Real</i>	-32768...32767	-	1 = 1
47.23	Data storage 3 int16	<i>Real</i>	-32768...32767	-	1 = 1
47.24	Data storage 4 int16	<i>Real</i>	-32768...32767	-	1 = 1
49 Panel port communication					
49.01	Node ID number	<i>Real</i>	1...32	-	1 = 1
49.03	Baud rate	<i>List</i>	1...5	-	1 = 1
49.04	Communication loss time	<i>Real</i>	0.3...3000.0	s	10 = 1 s
49.05	Communication loss action	<i>List</i>	0...3	-	1 = 1
49.06	Refresh settings	<i>List</i>	0...1	-	1 = 1
49.19	Basic panel home view 1	<i>Binary src</i>	-	-	1 = 1
49.20	Basic panel home view 2	<i>Binary src</i>	-	-	1 = 1
49.21	Basic panel home view 3	<i>Binary src</i>	-	-	1 = 1
49.30	Basic panel menu hiding	<i>PB</i>	0000h...FFFFh	-	1 = 1
49.219	Basic panel home view 4	<i>Binary src</i>	-	-	1 = 1
49.220	Basic panel home view 5	<i>Binary src</i>	-	-	1 = 1
49.221	Basic panel home view 6	<i>Binary src</i>	-	-	1 = 1
58 Embedded fieldbus					
58.01	Protocol enable	<i>List</i>	0, 1, 3	-	1 = 1
58.02	Protocol ID	<i>Real</i>	0...65535	-	1 = 1
58.03	Node address Node ID	<i>Real</i>	0...255	-	1 = 1
58.04	Baud rate	<i>List</i>	0...7	-	1 = 1
58.05	Parity	<i>List</i>	0...3	-	1 = 1
58.06	Communication control	<i>List</i>	0...2	-	1 = 1

348 Additional parameter data

No.	Name	Type	Range	Unit	FbEq32
58.07	Communication diagnostics	<i>PB</i>	0000h...FFFFh	-	1 = 1
58.08	Received packets	<i>Real</i>	0...4294967295	-	1 = 1
58.09	Transmitted packets	<i>Real</i>	0...4294967295	-	1 = 1
58.10	All packets	<i>Real</i>	0...4294967295	-	1 = 1
58.11	UART errors	<i>Real</i>	0...4294967295	-	1 = 1
58.12	CRC errors	<i>Real</i>	0...4294967295	-	1 = 1
58.14	Communication loss action	<i>List</i>	0...4	-	1 = 1
58.15	Communication loss mode	<i>List</i>	0...2	-	1 = 1
58.16	Communication loss time	<i>Real</i>	0.0...6000.0	s	10 = 1 s
58.17	Transmit delay	<i>Real</i>	0...65535	ms	1 = 1 ms
58.18	EFB control word	<i>PB</i>	0...FFFFFFFFh	-	1 = 1
58.19	EFB status word	<i>PB</i>	0...FFFFFFFFh	-	1 = 1
58.25	Control profile	<i>List</i>	0, 5, 7, 8, 9	-	1 = 1
58.26	EFB ref1 type	<i>List</i>	0...5	-	1 = 1
58.27	EFB ref2 type	<i>List</i>	0...5	-	1 = 1
58.28	EFB act1 type	<i>List</i>	0...5	-	1 = 1
58.29	EFB act2 type	<i>List</i>	0...5	-	1 = 1
58.31	EFB act1 transparent source	<i>Analog src</i>	-	-	1 = 1
58.32	EFB act2 transparent source	<i>Analog src</i>	-	-	1 = 1
58.33	Addressing mode	<i>List</i>	0...2	-	1 = 1
58.34	Word order	<i>List</i>	0...1	-	1 = 1
58.70	EFB debug mode	<i>List</i>	-100000...100000	-	1 = 1
58.71	EFB reference 1	<i>Real</i>	-100000...100000	-	1 = 1
58.72	EFB reference 2	<i>Real</i>	-100000...100000	-	1 = 1
58.73	EFB actual value 1	<i>Real</i>	-100000...100000	-	1 = 1
58.74	EFB actual value 2	<i>Real</i>	-100000...100000	-	1 = 1
58.101	Data I/O 1	<i>Analog src</i>	-	-	1 = 1
58.102	Data I/O 2	<i>Analog src</i>	-	-	1 = 1
58.103	Data I/O 3	<i>Analog src</i>	-	-	1 = 1
58.104	Data I/O 4	<i>Analog src</i>	-	-	1 = 1
58.105	Data I/O 5	<i>Analog src</i>	-	-	1 = 1
58.106	Data I/O 6	<i>Analog src</i>	-	-	1 = 1
58.107	Data I/O 7	<i>Analog src</i>	-	-	1 = 1
58.108	Data I/O 8	<i>Analog src</i>	-	-	1 = 1
58.109	Data I/O 9	<i>Analog src</i>	-	-	1 = 1
58.110	Data I/O 10	<i>Analog src</i>	-	-	1 = 1
58.111	Data I/O 11	<i>Analog src</i>	-	-	1 = 1
58.112	Data I/O 12	<i>Analog src</i>	-	-	1 = 1
58.113	Data I/O 13	<i>Analog src</i>	-	-	1 = 1
58.114	Data I/O 14	<i>Analog src</i>	-	-	1 = 1

No.	Name	Type	Range	Unit	FbEq32
71 External PID1					
71.01	External PID act value	<i>Real</i>	-200000.00...200000.00	rpm, % or Hz	100 = 1 unit
71.02	Feedback act value	<i>Real</i>	-200000.00...200000.00	rpm, % or Hz	100 = 1 unit
71.03	Setpoint act value	<i>Real</i>	-200000.00...200000.00	rpm, % or Hz	100 = 1 unit
71.04	Deviation act value	<i>Real</i>	-200000.00...200000.00	rpm, % or Hz	100 = 1 unit
71.06	PID status word	<i>PB</i>	0000h...FFFFh	-	1 = 1
71.07	PID operation mode	<i>List</i>	0...2	-	1 = 1
71.08	Feedback 1 source	<i>Analog src</i>	-	-	1 = 1
71.11	Feedback filter time	<i>Real</i>	0.000...30.000	s	1000 = 1 s
71.14	Setpoint scaling	<i>Real</i>	-200000.00...200000.00	-	100 = 1
71.15	Output scaling	<i>Real</i>	-200000.00...200000.00	-	100 = 1
71.16	Setpoint 1 source	<i>Analog src</i>	-	-	1 = 1
71.19	Internal setpoint sel1	<i>Binary src</i>	-	-	1 = 1
71.20	Internal setpoint sel2	<i>Binary src</i>	-	-	1 = 1
71.21	Internal setpoint 1	<i>Real</i>	-200000.00...200000.00	rpm, % or Hz	100 = 1 unit
71.22	Internal setpoint 2	<i>Real</i>	-200000.00...200000.00	rpm, % or Hz	100 = 1 unit
71.23	Internal setpoint 3	<i>Real</i>	-200000.00...200000.00	rpm, % or Hz	100 = 1 unit
71.26	Setpoint min	<i>Real</i>	-200000.00...200000.00	-	100 = 1
71.27	Setpoint max	<i>Real</i>	-200000.00...200000.00	-	100 = 1
71.31	Deviation inversion	<i>Binary src</i>	-	-	1 = 1
71.32	Gain	<i>Real</i>	0.10...100.00	-	100 = 1
71.33	Integration time	<i>Real</i>	0.0...9999.0	s	10 = 1 s
71.34	Derivation time	<i>Real</i>	0.000...10.000	s	1000 = 1 s
71.35	Derivation filter time	<i>Real</i>	0.0...10.0	s	10 = 1 s
71.36	Output min	<i>Real</i>	-200000.00...200000.00	-	10 = 1
71.37	Output max	<i>Real</i>	-200000.00...200000.00	-	10 = 1
71.38	Output freeze enable	<i>Binary src</i>	-	-	1 = 1
71.39	Deadband range	<i>Real</i>	0.0...200000.0	-	10 = 1
71.40	Deadband delay	<i>Real</i>	0.0...3600.0	s	10 = 1 s
71.58	Increase prevention	<i>List</i>	0...3	-	1 = 1
71.59	Decrease prevention	<i>List</i>	0...3	-	1 = 1
71.62	Internal setpoint actual	<i>Real</i>	-200000.00...200000.00	rpm,% or Hz	100 = 1 unit
71.79	External PID units	<i>Real</i>	-200000.00...200000.00	rpm,% or Hz	100 = 1 unit
95 HW configuration					
95.01	Supply voltage	<i>List</i>	0...5	-	1 = 1

350 Additional parameter data

No.	Name	Type	Range	Unit	FbEq32
95.02	Adaptive voltage limits	List	0..1	-	1 = 1
95.03	Estimated AC supply voltage	Real	0..65535	-	1 = 1 V
95.20	HW options word 1	PB	0000h...FFFFh	-	1 = 1
95.26	Motor disconnect detection	List	0..1	-	1 = 1
95.200	Cooling fan mode	PB	0000h...FFFFh	-	1 = 1
96 System					
96.01	Language	List	-	-	1 = 1
96.02	Pass code	Data	0..99999999	-	1 = 1
96.03	Access levels status	PB	0b0000...0b1111	-	1 = 1
96.04	Macro select	List	0, 1, 5, 8, 9, 12...14	-	1 = 1
96.05	Macro active	List	0, 1, 5, 8, 9, 12...14	-	1 = 1
96.06	Parameter restore	List	0, 8, 62	-	1 = 1
96.07	Parameter save manually	List	0..1	-	1 = 1
96.08	Control board boot	Real	0..1	-	1 = 1
96.10	User set status	List	0..7, 20...23	-	-
96.11	User set save/load	List	0..5, 18...21	-	-
96.12	User set I/O mode in1	Binary src	-	-	-
96.13	User set I/O mode in2	Binary src	-	-	-
96.16	Unit selection	PB	0b0000...0b1111	-	1 = 1
96.51	Clear fault and event logger	Real	0..1	-	1 = 1
96.54	Checksum action	List	0..4	-	1 = 1
96.55	Checksum control word	PB	0b0000...0b1111	-	1 = 1
96.68	Actual checksum A	Real	0x0000...0xffff	-	1 = 1
96.69	Actual checksum B	Real	0x0000...0xffff	-	1 = 1
96.70	Disable adaptive program	List	0..1	-	1 = 1
96.71	Approved checksum A	Real	0x0000...0xffff	-	1 = 1
96.72	Approved checksum B	Real	0x0000...0xffff	-	1 = 1
96.78	Legacy Modbus mapping	List	0..1	-	1 = 1
96.79	Legacy control profile	List	0..3	-	1 = 1
<i>(Parameters 96.100...96.102 only visible when enabled by parameter 96.02)</i>					
96.100	Change user pass code	Data	10000000...99999999	-	1 = 1
96.101	Confirm user pass code	Data	10000000...99999999	-	1 = 1
96.102	User lock functionality	PB	0000h...FFFFh	-	1 = 1
97 Motor control					
97.01	Switching frequency reference	List	4...12	kHz	1 = 1
97.02	Minimum switching frequency	List	1...12	kHz	1 = 1
97.03	Slip gain	Real	0..200	%	1 = 1%
97.04	Voltage reserve	Real	-5...50	%	1 = 1%
97.05	Flux braking	List	0..2	-	1 = 1

No.	Name	Type	Range	Unit	FbEq32
97.06	Flux reference select	<i>Binary src</i>	-	-	1 = 1
97.07	User flux reference	<i>Real</i>	0.0...200.0	%	100 = 1%
97.08	Optimizer minimum torque	<i>Real</i>	0.0...1600.0	%	10 = 1%
97.11	TR tuning	<i>Real</i>	25...400	%	1 = 1%
97.13	IR compensation	<i>Real</i>	0.00...50.00	%	100 = 1%
97.15	Motor model temperature adaptation	<i>List</i>	0...1	-	1 = 1
97.16	Stator temperature factor	<i>Real</i>	0...200	%	1=1%
97.17	Rotor temperature factor	<i>Real</i>	0...200	%	1=1%
97.20	U/f ratio	<i>List</i>	0...1	-	1 = 1
97.33	Speed estimate filter time	<i>Real</i>	0.00...100.00	-	1 = 1
97.48	Udc stabilizer	<i>List</i>	0, 50, 100, 300, 500, 800	%	1 = 1%
97.49	Slip gain for scalar	<i>Real</i>	0...200	%	1 = 1%
97.94	IR comp max frequency	<i>Real</i>	1.0...200.0	%	10 = 1%
97.135	Udc ripple	<i>Real</i>	0.0...200.0	V	10 = 1V
98 User motor parameters					
98.01	User motor model mode	<i>List</i>	0...1	-	1 = 1
98.02	Rs user	<i>Real</i>	0.0000...0.50000	p.u.	100000 = 1 p.u.
98.03	Rr user	<i>Real</i>	0.0000...0.50000	p.u.	100000 = 1 p.u.
98.04	Lm user	<i>Real</i>	0.00000...10.00000	p.u.	100000 = 1 p.u.
98.05	SigmaL user	<i>Real</i>	0.00000...1.00000	p.u.	100000 = 1 p.u.
98.06	Ld user	<i>Real</i>	0.00000...10.00000	p.u.	100000 = 1 p.u.
98.07	Lq user	<i>Real</i>	0.00000...10.00000	p.u.	100000 = 1 p.u.
98.08	PM flux user	<i>Real</i>	0.00000...2.00000	p.u.	100000 = 1 p.u.
98.09	Rs user SI	<i>Real</i>	0.00000...100.00000	ohm	100000 = 1 p.u.
98.10	Rr user SI	<i>Real</i>	0.00000...100.00000	ohm	100000 = 1 p.u.
98.11	Lm user SI	<i>Real</i>	0.00...100000.00	mH	100 = 1 mH
98.12	SigmaL user SI	<i>Real</i>	0.00...100000.00	mH	100 = 1 mH
98.13	Ld user SI	<i>Real</i>	0.00...100000.00	mH	100 = 1 mH
98.14	Lq user SI	<i>Real</i>	0.00...100000.00	mH	100 = 1 mH
99 Motor data					
99.03	Motor type	<i>List</i>	0...1	-	1 = 1
99.04	Motor control mode	<i>List</i>	0...1	-	1 = 1
99.06	Motor nominal current	<i>Real</i>	0.0...6400.0	A	See P46.44.
99.07	Motor nominal voltage	<i>Real</i>	0.0...800.0	V	See P46.43.

352 *Additional parameter data*

No.	Name	Type	Range	Unit	FbEq32
99.08	Motor nominal frequency	<i>Real</i>	0.00 ... 500.00	Hz	100 = 1 Hz
99.09	Motor nominal speed	<i>Real</i>	0 ... 30000	rpm	1 = 1 rpm
99.10	Motor nominal power	<i>Real</i>	-10000.00...10000.00 kW or -13405.83 ... 13405.83 hp	kW or hp	100 = 1 unit
99.11	Motor nominal cos Φ	<i>Real</i>	0.00 ... 1.00	-	100 = 1
99.12	Motor nominal torque	<i>Real</i>	0.000...	N·m or lb·ft	1000 = 1 unit
99.13	ID run requested	<i>List</i>	0...4, 6	-	1 = 1
99.14	Last ID run performed	<i>List</i>	0...4, 6	-	1 = 1
99.15	Motor polepairs calculated	<i>Real</i>	0...1000	-	1 = 1
99.16	Motor phase order	<i>List</i>	0...1	-	1 = 1



Fault tracing

What this chapter contains

- *Safety*
- *Indications*
- *Warning/fault history*
- *QR Code generation for mobile service application*
- *Warning messages*
- *Fault messages*

If the warnings and faults cannot be identified and corrected using the information in this chapter, contact an ABB service representative. If you use the Drive composer PC tool, send the Support package created by the Drive composer to the ABB service representative.

Warnings and faults are listed in separate tables. Each table is sorted by a warning/fault code.

Safety



WARNING! Only qualified electricians are allowed to service the drive. Read the instructions in chapter *Safety instructions* at the beginning of the hardware manual of the drive before working on the drive.

Indications

■ Warnings and faults

Warnings and faults indicate an abnormal drive status. The codes and names of active warnings and faults are displayed on the control panel of the drive as well as in the Drive composer PC tool. Only the codes of warnings and faults are available over fieldbus.

Warnings do not need to be reset; they stop showing when the cause of the warning ceases. Warnings do not latch and the drive will continue to operate the motor.

Faults latch inside the drive and cause the drive to trip, and the motor stops. After the cause of a fault has been removed, the fault can be reset from parameter *31.11 Fault reset selection* (such as the control panel, Drive composer PC tool, the digital inputs of the drive, or fieldbus). Resetting the fault creates an event *64FF Fault reset*. After the reset, the drive can be restarted.

Note that some faults require a reboot of the control unit either by switching the power off and on, or using parameter *96.08 Control board boot* – this is mentioned in the fault listing wherever appropriate.

■ Pure events

In addition to warnings and faults, there are pure events that are only recorded in the event log of the drive. The codes of these events are included in the *Warning messages* table on page *356*.

Warning/fault history

■ Event log

All indications are stored in the event log. The event log stores information on

- the last 8 fault recordings, that is, faults that tripped the drive or fault resets
- the last 10 warnings or pure events that occurred.

See section *Viewing warning/fault information* on page *355*. The logs can be cleared using parameter *96.51 Clear fault and event logger*.

Auxiliary codes

Some events generate an auxiliary code that often helps in pinpointing the problem. On the control panel, the auxiliary code is stored as part of the details of the event; in the Drive composer PC tool, the auxiliary code is shown in the event listing.

■ Viewing warning/fault information

The drive is able to store a list of the active faults actually causing the drive to trip at the present time. The drive also stores a list of faults and warnings that have previously occurred.

For each stored fault, the panel shows the fault code, time and values of nine parameters (actual signals and status words) stored at the time of the fault. The values of the parameters for the latest fault are in parameters *05.80...05.88*.

For active faults and warnings, see

- **Main menu - Diagnostics - Active faults**
- **Main menu - Diagnostics - Active warnings**
- **Options menu - Active faults**
- **Options menu - Active warnings**
- parameters in group *04 Warnings and faults* (page 115).

For previously occurred faults and warnings, see

- **Main menu - Diagnostics - Fault & event log**
- **Note:** Active faults are also stored in the fault and event log.
- parameters in group *04 Warnings and faults* (page 115).

The event log can also be accessed (and reset) using the Drive composer PC tool. See *Drive composer PC tool user's manual* (3AUA0000094606 [English]).

QR Code generation for mobile service application

A QR Code (or a series of QR Codes) can be generated by the drive for display on the assistant control panel. The QR Code contains drive identification data, information on the latest events, and values of status and counter parameters. The code can be read with a mobile device containing the ABB service application, which then sends the data to ABB for analysis. For more information on the application, contact your local ABB service representative.

Warning messages

Note: The list also contains events that only appear in the Event log.

Code (hex)	Warning / Aux. code	Cause	What to do
64FF	Fault reset	A fault has been reset from the panel, Drive composer PC tool, fieldbus or I/O.	Event. Informative only.
A2A1	Current calibration	Current offset and gain measurement calibration will occur at next start.	Informative warning. (See parameter <i>99.13 ID run requested.</i>)
A2B1	Overcurrent	Output current has exceeded internal fault limit. In addition to an actual overcurrent situation, this warning may also be caused by an earth fault or supply phase loss.	Check motor load. Check acceleration times in parameter group <i>23 Speed reference ramp</i> (speed control), <i>26 Torque reference chain</i> (torque control) or <i>28 Frequency reference chain</i> (frequency control). Also check parameters <i>46.01 Speed scaling</i> , <i>46.02 Frequency scaling</i> and <i>46.03 Torque scaling</i> . Check motor and motor cable (including phasing and delta/star connection). Check for an earth fault in motor or motor cables by measuring the insulation resistances of motor and motor cable. See chapter <i>Electrical installation</i> , section <i>Checking the insulation of the assembly</i> in the hardware manual of the drive. Check there are no contactors opening and closing in motor cable. Check that the start-up data in parameter group <i>99 Motor data</i> corresponds to the motor rating plate. Check that there are no power factor correction capacitors or surge absorbers in motor cable.
A2B3	Earth leakage	Drive has detected load unbalance typically due to earth fault in motor or motor cable.	Check there are no power factor correction capacitors or surge absorbers in motor cable. Check for an earth fault in motor or motor cables by measuring the insulation resistances of motor and motor cable. See chapter <i>Electrical installation</i> , section <i>Checking the insulation of the assembly</i> in the hardware manual of the drive. If an earth fault is found, fix or change the motor cable and/or motor. If no earth fault can be detected, contact your local ABB representative.

Code (hex)	Warning / Aux. code	Cause	What to do
A2B4	Short circuit	Short-circuit in motor cable(s) or motor.	<p>Check motor and motor cable for cabling errors.</p> <p>Check motor and motor cable (including phasing and delta/star connection).</p> <p>Check for an earth fault in motor or motor cables by measuring the insulation resistances of motor and motor cable. See chapter <i>Electrical installation</i>, section <i>Checking the insulation of the assembly</i> in the hardware manual of the drive.</p> <p>Check there are no power factor correction capacitors or surge absorbers in motor cable.</p>
A2BA	IGBT overload	Excessive IGBT junction to case temperature. This warning protects the IGBT(s) and can be activated by a short circuit in the motor cable.	<p>Check motor cable.</p> <p>Check ambient conditions.</p> <p>Check air flow and fan operation.</p> <p>Check heatsink fins for dust pick-up.</p> <p>Check motor power against drive power.</p>
A3A1	DC link overvoltage	Intermediate circuit DC voltage too high (when the drive is stopped).	<p>Check the supply voltage setting (parameter <i>95.01 Supply voltage</i>). Note that the wrong setting of the parameter may cause the motor to rush uncontrollably, or may overload the brake chopper or resistor.</p> <p>Check the supply voltage.</p> <p>If the problem persists, contact your local ABB representative.</p>
A3A2	DC link undervoltage	Intermediate circuit DC voltage too low (when the drive is stopped).	
A3AA	DC not charged	The voltage of the intermediate DC circuit has not yet risen to operating level.	
A490	Incorrect temperature sensor setup	Sensor type mismatch.	Check the settings of temperature source parameters <i>35.11</i> .
A491	External temperature 1 (Editable message text)	Measured temperature 1 has exceeded warning limit.	<p>Check the value of parameter <i>35.02 Measured temperature 1</i>.</p> <p>Check the cooling of the motor (or other equipment whose temperature is being measured).</p> <p>Check the value of <i>35.13 Temperature 1 warning limit</i>.</p>
A4A1	IGBT overtemperature	Estimated drive IGBT temperature is excessive.	<p>Check ambient conditions.</p> <p>Check air flow and fan operation.</p> <p>Check heatsink fins for dust pick-up.</p> <p>Check motor power against drive power.</p>

Code (hex)	Warning / Aux. code	Cause	What to do
A4A9	Cooling	Drive module temperature is excessive.	Check ambient temperature. If it exceeds 50 °C /122 °F, ensure that load current does not exceed derated load capacity of drive. See chapter <i>Technical data</i> , section <i>Derating</i> in the hardware manual of the drive. Check drive module cooling air flow and fan operation. Check inside of cabinet and heatsink of drive module for dust pick-up. Clean whenever necessary.
A4B0	Excess temperature	Power unit module temperature is excessive.	Check ambient conditions. Check air flow and fan operation. Check heatsink fins for dust pick-up. Check motor power against drive power.
A4B1	Excess temperature difference	High temperature difference between the IGBTs of different phases.	Check the motor cabling. Check cooling of drive module(s).
A4F6	IGBT temperature	Drive IGBT temperature is excessive.	Check ambient conditions. Check air flow and fan operation. Check heatsink fins for dust pick-up. Check motor power against drive power.
A580	PU communication	Communication errors detected between the drive control unit and the power unit.	Check the connections between the drive control unit and the power unit.
A591	Drive HW initialization	Initialization of the drive hardware.	Check the auxiliary code. See actions for each code below.
	0000	Drive hardware setup is initializing.	Wait for the setup to initialize.
	0001	Initializing HW settings for the first time.	Wait for the setup to initialize.
A5A0	Safe torque off Programmable warning: <i>31.22 STO indication run/stop</i>	Safe torque off function is active, ie safety circuit signal(s) connected to connector STO is lost.	Check safety circuit connections. For more information, see chapter <i>The Safe torque off function</i> in the hardware manual of the drive and description of parameter <i>31.22 STO indication run/stop</i> (page 216).
A5EA	Measurement circuit temperature	Problem with internal temperature measurement of the drive.	Contact your local ABB representative.
A5EB	PU board powerfail	Power unit power supply failure.	Contact your local ABB representative.
A5EC	PU communication internal	Communication errors detected between the drive control unit and the power unit.	Check the connections between the drive control unit and the power unit.
A5ED	Measurement circuit ADC	Measurement circuit fault.	Contact your local ABB representative.

Code (hex)	Warning / Aux. code	Cause	What to do
A5EE	Measurement circuit DFF	Measurement circuit fault.	Contact your local ABB representative.
A5EF	PU state feedback	State feedback from output phases does not match control signals.	Contact your local ABB representative.
A5F0	Charging feedback	Charging feedback signal missing.	Check the feedback signal coming from the charging system.
A686	Checksum mismatch Programmable warning: <i>96.54 Checksum action</i>	The calculated parameter checksum does not match any enabled reference checksum.	Check that all necessary approved (reference) checksums (<i>96.71...96.72</i>) are enabled in <i>96.55 Checksum control word</i> . Check the parameter configuration. Using <i>96.55 Checksum control word</i> , enable a checksum parameter and copy the actual checksum into that parameter.
A687	Checksum configuration	An action has been defined for a parameter checksum mismatch but the feature has not been configured.	Contact your local ABB representative for configuring the feature, or disable the feature in <i>96.54 Checksum action</i> .
A6A4	Motor nominal value	The motor parameters are set incorrectly.	Check the settings of the motor configuration parameters in group 99.
		The drive is not dimensioned correctly.	Check that the drive is sized correctly for the motor.
A6A5	No motor data	Parameters in group 99 have not been set.	Check that all the required parameters in group 99 have been set. Note: It is normal for this warning to appear during the start-up and continue until the motor data is entered.
A6A6	Voltage category unselected	The voltage category has not been defined.	Set voltage category in parameter <i>95.01 Supply voltage</i> .
A6B0	User lock is open	The user lock is open, ie. user lock configuration parameters <i>96.100...96.102</i> are visible.	Close the user lock by entering an invalid pass code in parameter <i>96.02 Pass code</i> . See section <i>User lock</i> (page 105).
A6B1	User pass code not confirmed	A new user pass code has been entered in parameter <i>96.100</i> but not confirmed in <i>96.101</i> .	Confirm the new pass code by entering the same code in <i>96.101</i> . To cancel, close the user lock without confirming the new code. See section <i>User lock</i> (page 105).

Code (hex)	Warning / Aux. code	Cause	What to do
A6E5	Al parametrization	The current/voltage hardware setting of an analog input does not correspond to parameter settings.	Check the event log for an auxiliary code. The code identifies the analog input whose settings are in conflict. Adjust parameter <i>12.15/12.25</i> . Note: Control board reboot (either by cycling the power or through parameter <i>96.08 Control board boot</i>) is required to validate any changes in the hardware settings.
A6E6	ULC configuration	User load curve configuration error.	Check the auxiliary code. See actions for each code below.
	0000	Speed points inconsistent.	Check that each speed point (parameters <i>37.11...37.15</i>) has a higher value than the previous point.
	0001	Frequency points inconsistent.	Check that each frequency point (<i>37.16...37.20</i>) has a higher value than the previous point.
	0002	Underload point above overload point.	Check that each overload point (<i>37.31...37.35</i>) has a higher value than the corresponding underload point (<i>37.21...37.25</i>).
	0003	Overload point below underload point.	
A783	Motor overload	Motor current is too high.	Check the motor, and the machinery coupled to motor, for overload. Adjust the parameters used for the motor overload function (<i>35.51...35.53</i>) and <i>35.55...35.56</i> .
A784	Motor disconnect	All three output phases are disconnected from motor.	Check if parameter <i>95.26</i> enables the use of a motor disconnect switch. If not, check the following: <ul style="list-style-type: none"> • All switches between drive and motor are closed. • All cables between drive and motor are connected and secured. If no issue was detected and drive output was actually connected to motor, contact ABB.
A780	Motor stall Programmable warning: <i>31.24 Stall function</i>	Motor is operating in stall region because of e.g. excessive load or insufficient motor power.	Check motor load and drive ratings. Check fault function parameters.
A791	Brake resistor	Brake resistor broken or not connected.	Check that a brake resistor has been connected. Check the condition of the brake resistor.

Code (hex)	Warning / Aux. code	Cause	What to do
A793	BR excess temperature	Brake resistor temperature has exceeded warning limit defined by parameter <i>43.12 Brake resistor warning limit</i> .	Stop drive. Let resistor cool down. Check resistor overload protection function settings (parameter group <i>43 Brake chopper</i>). Check warning limit setting, parameter <i>43.12 Brake resistor warning limit</i> . Check that the resistor has been dimensioned correctly. Check that braking cycle meets allowed limits.
A794	BR data	Brake resistor data has not been given.	Check the resistor data settings (parameters <i>43.08...43.10</i>).
A79C	BC IGBT excess temperature	Brake chopper IGBT temperature has exceeded internal warning limit.	Let chopper cool down. Check for excessive ambient temperature. Check for cooling fan failure. Check for obstructions in the air flow. Check the dimensioning and cooling of the cabinet. Check resistor overload protection function settings (parameters <i>43.06...43.10</i>). Check minimum allowed resistor value for the chopper being used. Check that braking cycle meets allowed limits. Check that drive supply AC voltage is not excessive.
A7CE	EFB comm loss Programmable warning: <i>58.14 Communication loss action</i>	Communication break in embedded fieldbus (EFB) communication.	Check the status of the fieldbus master (online/offline/error etc.). Check cable connections to the EIA-485 terminals 25, 26, 27 and 28 on the control unit.
A7EE	Panel loss Programmable warning: <i>49.05 Communication loss action</i>	Control panel or PC tool selected as active control location for drive has ceased communicating.	Check PC tool or control panel connection. Check control panel connector. Check mounting platform if being used. Disconnect and reconnect the control panel.
A7AC	Main IOMCU internal error	Calibration data is not stored in the main IOMCU. Analog signals are not working with full accuracy.	Contact ABB
A8A0	AI supervision Programmable warning: <i>12.03 AI supervision function</i>	An analog signal is outside the limits specified for the analog input.	Check signal level at the analog input. Check the wiring connected to the input. Check the minimum and maximum limits of the input in parameter group <i>12 Standard AI</i> .
A8A1	RO life warning	The relay has changed states more than the recommended number of times.	Change the control board or stop using the relay output.

Code (hex)	Warning / Aux. code	Cause	What to do
	0001	Relay output 1	Change the control board or stop using relay output 1.
A8A2	RO toggle warning	The relay output is changing states faster than recommended, eg. if a fast changing frequency signal is connected to it. The relay lifetime will be exceeded shortly.	Replace the signal connected to the relay output source with a less frequently changing signal.
	0001	Relay output 1	Select a different signal with parameter <i>10.24 RO1 source</i> .
A8B0	Signal supervision (Editable message text) Programmable warning: <i>32.06 Supervision 1 action</i>	Warning generated by a signal supervision function.	Check the source of the warning (parameter <i>32.07 Supervision 1 signal</i>).
A8B1	Signal supervision (Editable message text) Programmable warning: <i>32.16 Supervision 2 action</i>	Warning generated by a signal supervision function.	Check the source of the warning (parameter <i>32.17 Supervision 2 signal</i>).
A8B2	Signal supervision (Editable message text) Programmable warning: <i>32.26 Supervision 3 action</i>	Warning generated by a signal supervision function.	Check the source of the warning (parameter <i>32.27 Supervision 3 signal</i>).
A8B3	Signal supervision (Editable message text) Programmable warning: <i>32.36 Supervision 4 action</i>	Warning generated by a signal supervision function.	Check the source of the warning (parameter <i>32.37 Supervision 4 signal</i>).
A8B4	Signal supervision (Editable message text) Programmable warning: <i>32.46 Supervision 5 action</i>	Warning generated by a signal supervision function.	Check the source of the warning (parameter <i>32.47 Supervision 5 signal</i>).
A8B5	Signal supervision (Editable message text) Programmable warning: <i>32.56 Supervision 6 action</i>	Warning generated by a signal supervision function.	Check the source of the warning (parameter <i>32.57 Supervision 6 signal</i>).

Code (hex)	Warning / Aux. code	Cause	What to do
A8C0	ULC invalid speed table	User load curve: X-axis points (speed) are not valid.	Check that points fulfill conditions. See parameter <i>37.11 ULC speed table point 1</i> .
A8C1	ULC overload warning	User load curve: Signal has been too long over the overload curve.	See parameter <i>37.03 ULC overload actions</i> .
A8C4	ULC underload warning	User load curve: Signal has been too long under the underload curve.	See parameter <i>37.04 ULC underload actions</i> .
A8C5	ULC invalid underload table	User load curve: Underload curve points are not valid.	Check that points fulfill conditions. See parameter <i>37.21 ULC underload point 1</i> .
A8C6	ULC invalid overload table	User load curve: Overload curve points are not valid.	Check that points fulfill conditions. See parameter <i>37.31 ULC overload point 1</i> .
A8C8	ULC invalid frequency table	User load curve: X-axis points (frequency) are not valid.	Check that points fulfill conditions. - $500.0 \text{ Hz} \leq 37.16 < 37.17 < 37.18 < 37.19 < 37.20 \leq 500.0 \text{ Hz}$. See parameter <i>37.16 ULC frequency table point 1</i> .
A981	External warning 1 (Editable message text) Programmable warning: <i>31.01 External event 1 source</i> <i>31.02 External event 1 type</i>	Fault in external device 1.	Check the external device. Check setting of parameter <i>31.01 External event 1 source</i> .
A982	External warning 2 (Editable message text) Programmable warning: <i>31.03 External event 2 source</i> <i>31.04 External event 2 type</i>	Fault in external device 2.	Check the external device. Check setting of parameter <i>31.03 External event 2 source</i> .
A983	External warning 3 (Editable message text) Programmable warning: <i>31.05 External event 3 source</i> <i>31.06 External event 3 type</i>	Fault in external device 3.	Check the external device. Check setting of parameter <i>31.05 External event 3 source</i> .

Code (hex)	Warning / Aux. code	Cause	What to do
A984	External warning 4 (Editable message text) Programmable warning: <i>31.07 External event 4 source</i> <i>31.08 External event 4 type</i>	Fault in external device 5.	Check the external device. Check setting of parameter <i>31.07 External event 4 source</i> .
A985	External warning 5 (Editable message text) Programmable warning: <i>31.09 External event 5 source</i> <i>31.10 External event 5 type</i>	Fault in external device 5.	Check the external device. Check setting of parameter <i>31.09 External event 5 source</i> .
AF8C	Process PID sleep mode	The drive is entering sleep mode.	Informative warning. See section <i>Sleep and boost functions for process PID control</i> , and parameters <i>40.43...40.48</i> .
AF90	Autotune	The autotune routine has been interrupted.	The code contains an auxiliary value that specifies the reason for the abortion. For details, see section <i>Speed controller autotune</i> .
AFAA	Autoreset	A fault is about to be autoreset.	Informative warning. See the settings in parameter group <i>31 Fault functions</i> .
AFE1	Emergency stop (off2)	Drive has received an emergency stop (mode selection off2) command.	Check that it is safe to continue operation. Then return emergency stop push button to normal position. Restart drive. If the emergency stop was unintentional, check the source selected by parameter <i>21.05 Emergency stop source</i> .
AFE2	Emergency stop (off1 or off3)	Drive has received an emergency stop (mode selection off1 or off3) command.	
AFEA	Enable start signal missing (Editable message text)	No enable start signal received.	Check the setting of (and the source selected by) parameter <i>20.19 Enable start command</i> .
AFE9	Start delay	The start delay is active and the drive will start the motor after a predefined delay.	Informative warning. See parameter <i>21.22 Start delay</i> .
AFEB	Run enable missing	No run enable signal is received.	Check setting of parameter <i>20.12 Run enable 1 source</i> . Switch signal on (e.g. in the fieldbus Control Word) or check wiring of selected source.
AFED	Enable to rotate	Signal enable to rotate has not been received within a fixed time delay of 240s.	Switch enable to rotate signal on (eg. in digital inputs). Check the setting of (and source selected by) parameter <i>20.22 Enable to rotate</i> .
AFF6	Identification run	Motor ID run will occur at next start.	Informative warning.

Code (hex)	Warning / Aux. code	Cause	What to do
AFF7	Autophasing	Autophasing will occur at next start.	Informative warning.
B5A0	STO event Programmable event: <i>31.22 STO indication run/stop</i>	Safe torque off function is active, ie. safety circuit signal(s) connected to connector STO is lost.	Check safety circuit connections. For more information, see chapter <i>The Safe torque off function</i> in the hardware manual of the drive and description of parameter <i>31.22 STO indication run/stop</i> (page 216).
B686	Checksum mismatch Programmable event: <i>96.54 Checksum action</i>	The calculated parameter checksum does not match any enabled reference checksum.	See <i>A686 Checksum mismatch</i> (page 359).

Fault messages

Code (hex)	Fault / Aux. code	Cause	What to do
1080	Backup/Restore timeout	Panel or PC tool has failed to communicate with the drive when backup was being made or restored.	Request backup or restore again.
1081	Rating ID fault	Drive software has not been able to read the rating ID of the drive.	Reset the fault to make the drive try to reread the rating ID. If the fault reappears, cycle the power to the drive. You may have to be repeat this. If the fault persists, contact your local ABB representative.
2281	Calibration	Measured offset of output phase current measurement or difference between output phase U2 and W2 current measurement is too great (the values are updated during current calibration).	Try performing the current calibration again. If the fault persists, contact your local ABB representative.
2310	Overcurrent	Output current has exceeded internal fault limit. In addition to an actual overcurrent situation, this fault may also be caused by an earth fault or supply phase loss.	Check motor load. Check acceleration times in parameter group <i>23 Speed reference ramp</i> (speed control), <i>26 Torque reference chain</i> (torque control) or <i>28 Frequency reference chain</i> (frequency control). Also check parameters <i>46.01 Speed scaling</i> , <i>46.02 Frequency scaling</i> and <i>46.03 Torque scaling</i> . Check motor and motor cable (including phasing and delta/star connection). Check there are no contactors opening and closing in motor cable. Check that the start-up data in parameter group <i>99 Motor data</i> corresponds to the motor rating plate. Check that there are no power factor correction capacitors or surge absorbers in motor cable. Check for an earth fault in motor or motor cables by measuring the insulation resistances of motor and motor cable. See chapter <i>Electrical installation</i> , section <i>Checking the insulation of the assembly</i> in the hardware manual of the drive.

Code (hex)	Fault / Aux. code	Cause	What to do
2330	Earth leakage Programmable fault: <i>30.20 Earth fault</i>	Drive has detected load unbalance typically due to earth fault in motor or motor cable.	Check there are no power factor correction capacitors or surge absorbers in motor cable. Check for an earth fault in motor or motor cables by measuring the insulation resistances of motor and motor cable. Try running the motor in scalar control mode if allowed. (See parameter <i>99.04 Motor control mode</i> .) If no earth fault can be detected, contact your local ABB representative.
2340	Short circuit	Short-circuit in motor cable(s) or motor. Aux code 0x0080 indicates that the state feedback from output phases does not match the control signals.	Check motor and motor cable for cabling errors. Check there are no power factor correction capacitors or surge absorbers in motor cable. Cycle the power to the drive.
2381	IGBT overload	Excessive IGBT junction to case temperature. This fault protects the IGBT(s) and can be activated by a short circuit in the motor cable.	Check motor cable. Check ambient conditions. Check air flow and fan operation. Check heatsink fins for dust pick-up. Check motor power against drive power.
3130	Input phase loss	Intermediate circuit DC voltage is oscillating due to missing input power line phase or blown fuse.	Check input power line fuses. Check for loose power cable connections. Check for input power supply imbalance.
3181	Cross connection Programmable fault: <i>31.23 Wiring or earth fault</i>	Incorrect input power and motor cable connection (ie. input power cable is connected to drive motor connection).	Check input power connections.
3210	DC link overvoltage	Excessive intermediate circuit DC voltage.	Check that overvoltage control is on (parameter <i>30.30 Overvoltage control</i>). Check that the supply voltage matches the nominal input voltage of the drive. Check the supply line for static or transient overvoltage. Check deceleration time. Use coast-to-stop function (if applicable). Retrofit drive with brake chopper and brake resistor. Check that the brake resistor is dimensioned properly and the resistance is between acceptable range for the drive.
3220	DC link undervoltage	Intermediate circuit DC voltage is not sufficient because of a missing supply phase, blown fuse or fault in the rectifier bridge.	Check supply cabling, fuses and switchgear.

Code (hex)	Fault / Aux. code	Cause	What to do
3385	Autophasing	Autophasing routine (see section <i>Autophasing</i> on page 66) has failed.	Check that the motor ID run has been successfully completed. Check that the motor is not already turning when the autophasing routine starts. Check the setting of parameter 99.03 <i>Motor type</i> .
3381	Output phase loss Programmable fault: 31.19 <i>Motor phase loss</i>	Motor circuit fault due to missing motor connection (any of the three phases not connected). In scalar control mode, the drive detects fault only when the output frequency is above 10% of the motor nominal frequency.	Connect motor cable. If the drive is in scalar mode and nominal current of the motor is less than 1/6 of the nominal output current of the drive, set parameter 31.19 <i>Motor phase loss</i> to <i>No action</i> .
4110	Control board temperature	Control board temperature is too high.	Check proper cooling of the drive. Check the auxiliary cooling fan.
4210	IGBT overtemperature	Estimated drive IGBT temperature is excessive.	Check ambient conditions. Check air flow and fan operation. Check heatsink fins for dust pick-up. Check motor power against drive power.
4290	Cooling	Drive module temperature is excessive.	Check ambient temperature. If it exceeds 50 °C /122 °F, ensure that load current does not exceed derated load capacity of drive. See chapter <i>Technical data</i> , section <i>Derating</i> in the hardware manual of the drive. Check drive module cooling air flow and fan operation. Check inside of cabinet and heatsink of drive module for dust pick-up. Clean whenever necessary.
42F1	IGBT temperature	Drive IGBT temperature is excessive.	Check ambient conditions. Check air flow and fan operation. Check heatsink fins for dust pick-up. Check motor power against drive power.
4310	Excess temperature	Power unit module temperature is excessive.	Check ambient conditions. Check air flow and fan operation. Check heatsink fins for dust pick-up. Check motor power against drive power.
4180	Excess temperature difference	High temperature difference between the IGBTs of different phases.	Check the motor cabling. Check cooling of drive module(s).
4981	External temperature 1 (Editable message text)	Measured temperature 1 has exceeded fault limit.	Check the value of parameter 35.02 <i>Measured temperature 1</i> . Check the cooling of the motor (or other equipment whose temperature is being measured). Check the value of parameter 35.12 <i>Temperature 1 fault limit</i> .

Code (hex)	Fault / Aux. code	Cause	What to do
5090	STO hardware failure	STO hardware diagnostics has detected hardware failure.	Contact your local ABB representative for hardware replacement.
5091	Safe torque off Programmable fault: <i>31.22 STO indication run/stop</i>	Safe torque off function is active, ie. safety circuit signal(s) connected to connector STO is broken during start or run.	Check safety circuit connections. For more information, see chapter <i>The Safe torque off function</i> in the hardware manual of the drive and description of parameter <i>31.22 STO indication run/stop</i> (page 216).
5092	PU logic error	Power unit memory has cleared.	Contact your local ABB representative.
5093	Rating ID mismatch	The hardware of the drive does not match the information stored in the memory. This may occur eg. after a firmware update.	Cycle the power to the drive. You may have to repeat this.
5094	Measurement circuit temperature	Problem with internal temperature measurement of the drive.	Contact your local ABB representative.
5098	I/O communication loss	Communication failure to standard I/O.	Try resetting the fault or cycle the power to the drive.
50A0	Fan	Cooling fan stuck or disconnected.	Check fan operation and connection. Replace fan if faulty.
5681	PU communication	Communication errors detected between the drive control unit and the power unit.	Check the connection between the drive control unit and the power unit.
5682	Power unit lost	Connection between the drive control unit and the power unit is lost.	Check the connection between the control unit and the power unit.
5690	PU communication internal	Internal communication error.	Contact your local ABB representative.
5691	Measurement circuit ADC	Measurement circuit fault.	Contact your local ABB representative.
5692	PU board powerfail	Power unit power supply failure.	Contact your local ABB representative.
5693	Measurement circuit DFF	Measurement circuit fault.	Contact your local ABB representative.
5696	PU state feedback	State feedback from output phases does not match control signals.	Contact your local ABB representative.
5697	Charging feedback	Charging feedback signal missing.	Check the feedback signal coming from the charging system.
6181	FPGA version incompatible	Firmware and FPGA versions are incompatible.	Reboot the control unit (using parameter <i>96.08 Control board boot</i>) or by cycling power. If the problem persists, contact your local ABB representative

Code (hex)	Fault / Aux. code	Cause	What to do
6200	Checksum mismatch Programmable event: <i>96.54 Checksum action</i>	The calculated parameter checksum does not match any enabled reference checksum.	See <i>A686 Checksum mismatch</i> (page 359).
6481	Task overload	Internal fault.	Reboot the control unit (using parameter <i>96.08 Control board boot</i>) or by cycling power. If the problem persists, contact your local ABB representative
6487	Stack overflow	Internal fault.	Reboot the control unit (using parameter <i>96.08 Control board boot</i>) or by cycling power. If the problem persists, contact your local ABB representative
64A1	Internal file load	File read error.	Reboot the control unit (using parameter <i>96.08 Control board boot</i>) or by cycling power. If the problem persists, contact your local ABB representative
64A6	Adaptive program file incompatible or corrupted	Adaptive program has faulted.	Check the auxiliary code. See actions for each code below.
	000A	Program corrupted or block non-existent.	Restore the template program or download the program to the drive.
	000C	Required block input missing.	Check the inputs of the block.
	000E	Program corrupted or block non-existent.	Restore the template program or download the program to the drive.
	0011	Program too large.	Remove blocks until the error stops.
	0012	Program is empty.	Correct the program and download it to the drive.
	001C	A non-existing parameter or block is used in the parameter.	Edit the program to correct the parameter reference, or use an existing block.
	001E	Output to parameter failed because the parameter was write-protected.	Check the parameter reference in the program. Check for other sources affecting the target parameter.
	0023	Program file incompatible with current firmware version.	Adapt the program to current block library and firmware version.
	0024	Program file incompatible with current firmware version.	Adapt the program to current block library and firmware version.
	Other	-	Contact your local ABB representative, quoting the auxiliary code.

Code (hex)	Fault / Aux. code	Cause	What to do
64B2	User set fault	Loading of user parameter set failed because <ul style="list-style-type: none"> • requested set does not exist • set is not compatible with control program • drive was switched off during loading. 	Ensure that a valid user parameter set exists. Reload if uncertain.
64E1	Kernel overload	Operating system error.	Reboot the control unit (using parameter <i>96.08 Control board boot</i>) or by cycling power. If the problem persists, contact your local ABB representative
6581	Parameter system	Parameter load or save failed.	Try forcing a save using parameter <i>96.07 Parameter save manually</i> . Retry.
6681	EFB comm loss Programmable fault: <i>58.14 Communication loss action</i>	Communication break in embedded fieldbus (EFB) communication.	Check the status of the fieldbus master (online/offline/error etc.). Check cable connections to the EIA-485 terminals 25, 26, 27 and 28 on the control unit.
6682	EFB config file	Embedded fieldbus (EFB) configuration file could not be read.	Contact your local ABB representative.
6683	EFB invalid parameterization	Embedded fieldbus (EFB) parameter settings inconsistent or not compatible with selected protocol.	Check the settings in parameter group <i>58 Embedded fieldbus</i> .
6684	EFB load fault	Embedded fieldbus (EFB) protocol firmware could not be loaded. Version mismatch between EFB protocol firmware and drive firmware.	Contact your local ABB representative.
6685	EFB fault 2	Fault reserved for the EFB protocol application.	Check the documentation of the protocol.
6686	EFB fault 3	Fault reserved for the EFB protocol application.	Check the documentation of the protocol.
6882	Text 32-bit table overflow	Internal fault.	Reset the fault. Contact your local ABB representative if the fault persists.
6885	Text file overflow	Internal fault.	Reset the fault. Contact your local ABB representative if the fault persists.
7081	Control panel loss Programmable fault: <i>49.05 Communication loss action</i>	Control panel or PC tool selected as active control location for drive has ceased communicating.	Check PC tool or control panel connection. Check control panel connector. Disconnect and reconnect the control panel.
7082	I/O module comm loss	Communication between IO module and drive is not working properly.	Replace the drive.

372 Fault tracing

Code (hex)	Fault / Aux. code	Cause	What to do
7086	I/O module AI Over voltage	Overvoltage detected in AI. AI is changed to voltage mode. AI will return automatically back to mA mode when the AI signal level is in accepted limits.	Check AI signal levels.
7121	Motor stall Programmable fault: <i>31.24 Stall function</i>	Motor is operating in stall region because of e.g. excessive load or insufficient motor power.	Check motor load and drive ratings. Check fault function parameters.
7122	Motor overload	Motor current is too high.	Check the motor, and the machinery coupled to motor, for overload. Adjust the parameters used for the motor overload function (<i>35.51...35.53</i>) and <i>35.55...35.56</i> .
7183	BR excess temperature	Brake resistor temperature has exceeded fault limit defined by parameter <i>43.11 Brake resistor fault limit</i> .	Stop drive. Let resistor cool down. Check resistor overload protection function settings (parameter group <i>43 Brake chopper</i>). Check fault limit setting, parameter <i>43.11 Brake resistor fault limit</i> . Check that braking cycle meets allowed limits.
7310	Overspeed	Motor is turning faster than highest allowed speed due to incorrectly set minimum/maximum speed, insufficient braking torque or changes in load when using torque reference.	Check minimum/maximum speed settings, parameters <i>30.11 Minimum speed</i> and <i>30.12 Maximum speed</i> . Check adequacy of motor braking torque. Check applicability of torque control. Check need for brake chopper and resistor(s).
73F0	Overfrequency	Maximum allowed output frequency exceeded.	Check minimum/maximum frequency settings, parameters <i>30.13 Minimum frequency</i> and <i>30.14 Maximum frequency</i> . Check adequacy of motor braking torque. Check applicability of torque control. Check need for brake chopper and resistor(s).
	00FA	Motor is turning faster than the highest allowed frequency due to incorrectly set minimum/maximum frequency or the motor rushes because of too high supply voltage or incorrect supply voltage selection in parameter <i>95.01 Supply voltage</i> .	Check minimum/maximum frequency settings, parameters <i>30.13 Minimum frequency</i> and <i>30.14 Maximum frequency</i> . Check used supply voltage and voltage selection parameter <i>95.01 Supply voltage</i> .

Code (hex)	Fault / Aux. code	Cause	What to do
	Other	-	Contact your local ABB representative, quoting the auxiliary code.
73B0	Emergency ramp failed	Emergency stop did not finish within expected time.	Check the settings of parameters <i>31.32 Emergency ramp supervision</i> and <i>31.33 Emergency ramp supervision delay</i> . Check the predefined ramp times (<i>23.11...23.15</i> for mode Off1, <i>23.23</i> for mode Off3).
8001	ULC underload fault	User load curve: Signal has been too long under the underload curve.	See parameter <i>37.04 ULC underload actions</i> .
8002	ULC overload fault	User load curve: Signal has been too long over the overload curve.	See parameter <i>37.03 ULC overload actions</i> .
80A0	AI supervision Programmable fault: <i>12.03 AI supervision function</i>	An analog signal is outside the limits specified for the analog input.	Check signal level at the analog input. Check the wiring connected to the input. Check the minimum and maximum limits of the input in parameter group <i>12 Standard AI</i> .
80B0	Signal supervision (Editable message text) Programmable fault: <i>32.06 Supervision 1 action</i>	Fault generated by the signal supervision 1 function.	Check the source of the fault (parameter <i>32.07 Supervision 1 signal</i>).
80B1	Signal supervision (Editable message text) Programmable fault: <i>32.16 Supervision 2 action</i>	Fault generated by the signal supervision 2 function.	Check the source of the fault (parameter <i>32.17 Supervision 2 signal</i>).
80B2	Signal supervision (Editable message text) Programmable fault: <i>32.26 Supervision 3 action</i>	Fault generated by the signal supervision 3 function.	Check the source of the fault (parameter <i>32.27 Supervision 3 signal</i>).
80B3	Signal supervision (Editable message text) Programmable fault: <i>32.36 Supervision 4 action</i>	Fault generated by the signal supervision 4 function.	Check the source of the fault (parameter <i>32.37 Supervision 4 signal</i>).
80B4	Signal supervision (Editable message text) Programmable fault: <i>32.46 Supervision 5 action</i>	Fault generated by the signal supervision 5 function.	Check the source of the fault (parameter <i>32.47 Supervision 5 signal</i>).

Code (hex)	Fault / Aux. code	Cause	What to do
80B5	Signal supervision (Editable message text) Programmable fault: <i>32.56 Supervision 6 action</i>	Fault generated by the signal supervision 6 function.	Check the source of the fault (parameter <i>32.57 Supervision 6 signal</i>).
9081	External fault 1 (Editable message text) Programmable fault: <i>31.01 External event 1 source</i> <i>31.02 External event 1 type</i>	Fault in external device 1.	Check the external device. Check setting of parameter <i>31.01 External event 1 source</i> .
9082	External fault 2 (Editable message text) Programmable fault: <i>31.03 External event 2 source</i> <i>31.04 External event 2 type</i>	Fault in external device 2.	Check the external device. Check setting of parameter <i>31.03 External event 2 source</i> .
9083	External fault 3 (Editable message text) Programmable fault: <i>31.05 External event 3 source</i> <i>31.06 External event 3 type</i>	Fault in external device 3.	Check the external device. Check setting of parameter <i>31.05 External event 3 source</i> .
9084	External fault 4 (Editable message text) Programmable fault: <i>31.07 External event 4 source</i> <i>31.08 External event 4 type</i>	Fault in external device 5.	Check the external device. Check setting of parameter <i>31.07 External event 4 source</i> .
9085	External fault 5 (Editable message text) Programmable fault: <i>31.09 External event 5 source</i> <i>31.10 External event 5 type</i>	Fault in external device 5.	Check the external device. Check setting of parameter <i>31.09 External event 5 source</i> .
FA81	Safe torque off 1	Safe torque off function is active, ie. STO circuit 1 is broken.	Check safety circuit connections. For more information, see chapter <i>The Safe torque off function</i> in the hardware manual of the drive and description of parameter <i>31.22 STO indication run/stop</i> (page 216).
FA82	Safe torque off 2	Safe torque off function is active, ie. STO circuit 2 is broken.	

Code (hex)	Fault / Aux. code	Cause	What to do
FF61	ID run	Motor ID run was not completed successfully.	Check the nominal motor values in parameter group <i>99 Motor data</i> . Check that no external control system is connected to the drive. Cycle the power to the drive (and its control unit, if powered separately). Check that no operation limits prevent the completion of the ID run. Restore parameters to default settings and try again. Check that the motor shaft is not locked.
	0001	Maximum current limit too low.	Check settings of parameters <i>99.06 Motor nominal current</i> and <i>30.17 Maximum current</i> . Make sure that $30.17 > 99.06$. Check that the drive is dimensioned correctly according to the motor.
	0002	Maximum speed limit or calculated field weakening point too low.	Check settings of parameters <ul style="list-style-type: none"> • <i>30.11 Minimum speed</i> • <i>30.12 Maximum speed</i> • <i>99.07 Motor nominal voltage</i> • <i>99.08 Motor nominal frequency</i> • <i>99.09 Motor nominal speed</i>. Make sure that <ul style="list-style-type: none"> • $30.12 > (0.55 \times 99.09) > (0.50 \times \text{synchronous speed})$ • $30.11 \leq 0$, and • supply voltage $\geq (0.66 \times 99.07)$.
	0003	Maximum torque limit too low.	Check settings of parameter <i>99.12 Motor nominal torque</i> , and the torque limits in group <i>30 Limits</i> . Make sure that the maximum torque limit in force is greater than 100%.
	0004	Current measurement calibration did not finish within reasonable time	Contact your local ABB representative.
	0005...0008	Internal error.	Contact your local ABB representative.
	0009	(Asynchronous motors only) Acceleration did not finish within reasonable time.	Contact your local ABB representative.
	000A	(Asynchronous motors only) Deceleration did not finish within reasonable time.	Contact your local ABB representative.
	000B	(Asynchronous motors only) Speed dropped to zero during ID run.	Contact your local ABB representative.
	000C	(Permanent magnet motors only) First acceleration did not finish within reasonable time.	Contact your local ABB representative.

376 Fault tracing

Code (hex)	Fault / Aux. code	Cause	What to do
	000D	(Permanent magnet motors only) Second acceleration did not finish within reasonable time.	Contact your local ABB representative.
	000E...0010	Internal error.	Contact your local ABB representative.
	0011	(Synchronous reluctance motors only) Pulse test error.	Contact your local ABB representative.
	0013	(Asynchronous motors only) Motor data error.	Check that the motor nominal value settings in the drive are the same as in the motor nameplate. Contact your local ABB representative.
FF8E	EFB force trip	A fault trip command has been received through the embedded fieldbus interface.	Check the fault information provided by the PLC.

9

Fieldbus control through the embedded fieldbus interface (EFB)

What this chapter contains

- *System overview*
 - *Modbus*
 - *Connecting the fieldbus to the drive*
 - *Setting up the embedded fieldbus interface (Modbus)*
 - *Setting the drive control parameters*
 - *Basics of the embedded fieldbus interface*
 - *About the control profiles*
 - *Control Word*
 - *Status Word*
 - *State transition diagrams*
 - *References*
 - *Actual values*
 - *Modbus holding register addresses*
 - *Modbus function codes*
 - *Exception codes*
 - *Coils (0xxxx reference set)*
 - *Discrete inputs (1xxxx reference set)*
 - *Error code registers (holding registers 400090...400100)*
-

System overview

The drive can be connected to an external control system through a communication link using the embedded fieldbus interface.

Modbus

The embedded fieldbus interface supports the Modbus RTU protocol. The drive control program can handle 10 Modbus registers in a 10-millisecond time level. For example, if the drive receives a request to read 20 registers, it will start its response within 22 ms of receiving the request – 20 ms for processing the request and 2 ms overhead for handling the bus. The actual response time depends on other factors as well, such as the baud rate (a parameter setting in the drive).

The drive can be set to receive all of its control information through the fieldbus interface, or the control can be distributed between the embedded fieldbus interface and other available sources, for example, digital and analog inputs.

■ Embedded fieldbus and external control panel mode switch

ACS180's embedded fieldbus and external control panel shares same port internally and can be switched by a jumper. You can't use external panel together with embedded fieldbus. If you have the EFB communication enabled in the drive, but need to change to a communication with an external panel temporarily, do these steps:

1. Power-down the drive, wait 5 minutes.
2. Place the jumper to "panel mode".
3. Connect the external panel onto the drive.
4. Power-up the drive.
5. The drive can identify the panel automatically and you can use the external panel as normal. Be noted that at this moment the EFB can not work.
6. After works done, power-down the drive.
7. Disconnect external panel from the drive.
8. Place the jumper J2 to "Modbus Mode".
9. Power-up the drive.

■ Connecting the fieldbus to the drive

Connect the fieldbus to the EIA-485 Modbus RTU terminal on the front of the drive.

The EIA-485 network uses shielded, twisted-pair cable for data signaling with

characteristic impedance between 100 and 130 ohm. The distributed capacitance between conductors is less than 100 pF per meter (30 pF per foot). Distributed capacitance between conductors and shield is less than 200 pF per meter (60 pF per foot). Foil or braided shields are acceptable. The connection diagram is shown below.

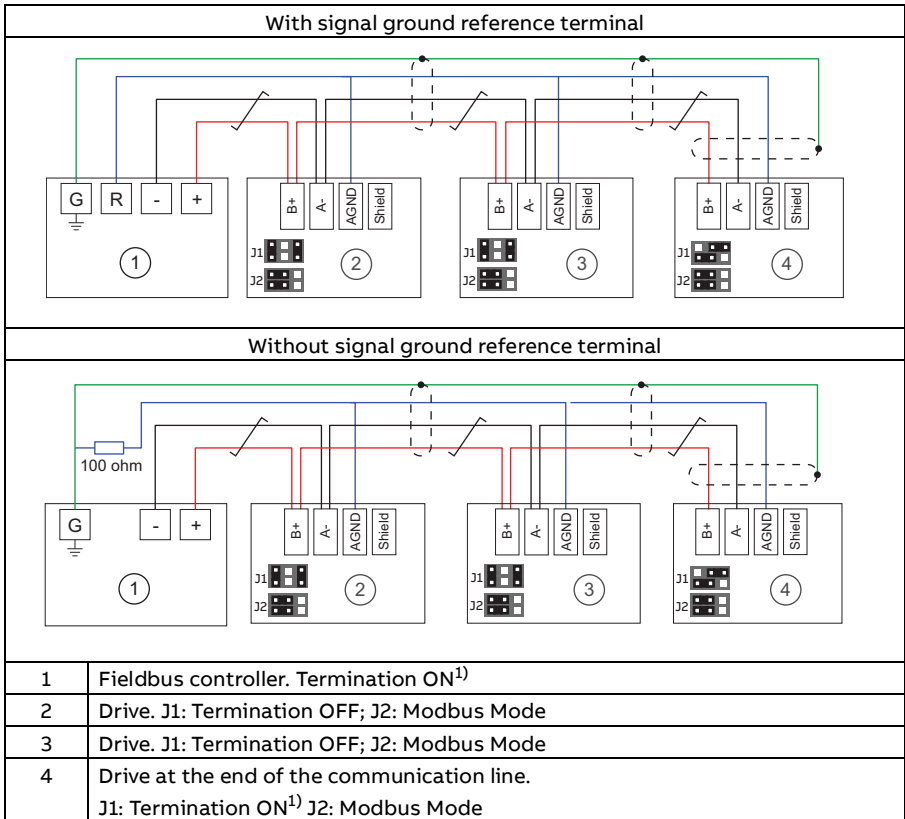

1) **Note:** The drive at both ends on the fieldbus must have termination set to ON.

■ Setting up the embedded fieldbus interface (Modbus)

To take the Modbus into use

1. Select *Modbus RTU* from the Control macros menu (see section on page 17).

The following parameters change automatically.

Parameter	Setting
20.01 Ext1 commands	Embedded fieldbus

Parameter	Setting
20.03 Ext1 in1	Not selected
20.04 Ext1 in2	Not selected
22.11 Ext1 speed ref1	EFB ref1
22.22 Constant speed sel1	Not selected
22.23 Constant speed sel2	Not selected
23.11 Ramp set selection	Acc/Dec time 1
28.11 Ext1 frequency ref1	EFB ref1
28.22 Constant frequency sel1	Not selected
28.23 Constant frequency sel2	Not selected
28.71 Freq ramp set sel	Acc/Dec time 1
31.11 Fault reset selection	DI1
58.01 Protocol enable	Modbus RTU

You can manually set the drive up for the embedded fieldbus communication with the parameters shown in the table below. The **Setting for fieldbus control** column gives either the value to use or the default value. The **Function/Information column** gives a description of the parameter.

Modbus parameter settings for embedded fieldbus interface

Parameter	Setting for fieldbus control	Function/Information
COMMUNICATION INITIALIZATION		
<i>58.01 Protocol enable</i>	<i>Modbus RTU</i>	Initializes embedded fieldbus communication.
EMBEDDED MODBUS CONFIGURATION		
<i>58.03 Node address</i>	1 (default)	Node address. There must be no two nodes with the same node address online.
<i>58.04 Baud rate</i>	19.2 kbps (default)	Defines the communication speed of the link. Use the same setting as in the master station.
<i>58.05 Parity</i>	8 EVEN 1 (default)	Selects the parity and stop bit setting. Use the same setting as in the master station.
<i>58.14 Communication loss action</i>	Fault (default)	Defines the action taken when a communication loss is detected.
<i>58.15 Communication loss mode</i>	Cw / Ref1 / Ref2 (default)	Enables/disables communication loss monitoring and defines the means for resetting the counter of the communication loss delay.
<i>58.16 Communication loss time</i>	3.0 s (default)	Defines the timeout limit for the communication monitoring.
<i>58.17 Transmit delay</i>	0 ms (default)	Defines a response delay for the drive.

Parameter	Setting for fieldbus control	Function/Information
58.25 <i>Control profile</i>	ABB Drives (default)	Selects the control profile used by the drive. See section <i>Basics of the embedded fieldbus interface</i> (page 384).
58.26 <i>EFB ref1 type</i> 58.27 <i>EFB ref2 type</i>	<i>Speed or frequency</i> (default for 58.26), <i>Transparent, General, Torque</i> (default for 58.27), <i>Speed, Frequency</i>	Defines the types of fieldbus references 1 and 2. The scaling for each reference type is defined by parameters 46.01...46.03. With the <i>Speed or frequency</i> setting, the type is selected automatically according to the currently active drive control mode.
58.28 <i>EFB act1 type</i> 58.29 <i>EFB act2 type</i>	<i>Speed or frequency</i> (default for 58.28), <i>Transparent</i> (default for 58.29), <i>General, Torque, Speed, Frequency</i>	Defines the types of actual values 1 and 2. The scaling for each actual value type is defined by parameters 46.01...46.03. With the <i>Speed or frequency</i> setting, the type is selected automatically according to the currently active drive control mode.
58.31 <i>EFB act1 transparent source</i> 58.32 <i>EFB act2 transparent source</i>	<i>Other</i>	Defines the source of actual values 1 and 2 when the 58.26 <i>EFB ref1 type</i> (58.27 <i>EFB ref2 type</i>) is set to <i>Transparent</i> .
58.33 <i>Addressing mode</i>	<i>Mode 0</i> (default)	Defines the mapping between parameters and holding registers in the 400001...465536 (100...65535) Modbus register range.
58.34 <i>Word order</i>	<i>LO-HI</i> (default)	Defines the order of the data words in the Modbus message frame.
58.101 <i>Data I/O 1</i> ... 58.114 <i>Data I/O 14</i>	For example, the default settings (I/Os 1...6 contain the control word, the status word, two references and two actual values)	Defines the address of the drive parameter which the Modbus master accesses when it reads from or writes to the register address corresponding to Modbus In/Out parameters. Select the parameters that you want to read or write through the Modbus I/O words.
	<i>RO/DIO control word, AO1 data storage, Feedback data storage, Setpoint data storage</i>	These settings write the incoming data into storage parameters 10.99 <i>RO/DIO control word</i> , 13.91 <i>AO1 data storage</i> , 40.91 <i>Feedback data storage</i> or 40.92 <i>Setpoint data storage</i> .

Parameter	Setting for fieldbus control	Function/Information
<i>58.06 Communication control</i>	<i>Refresh settings</i>	Validates the settings of the configuration parameters.

The new settings will take effect when the drive is powered up the next time, or when they are validated by parameter *58.06 Communication control (Refresh settings)*.

■ Setting the drive control parameters

After the embedded fieldbus interface has been set up, check and adjust the drive control parameters listed in the table below. The **Setting for fieldbus control** column gives the value or values to use when the embedded fieldbus signal is the desired source or destination for that particular drive control signal. The **Function/Information** column gives a description of the parameter.

Parameter	Setting for fieldbus control	Function/Information
-----------	------------------------------	----------------------

CONTROL COMMAND SOURCE SELECTION		
<i>20.01 Ext1 commands</i>	<i>Embedded fieldbus</i>	Selects fieldbus as the source for the start and stop commands when EXT1 is selected as the active control location.
<i>20.06 Ext2 commands</i>	<i>Embedded fieldbus</i>	Selects fieldbus as the source for the start and stop commands when EXT2 is selected as the active control location.

SPEED REFERENCE SELECTION		
<i>22.11 Ext1 speed ref1</i>	<i>EFB ref1</i>	Selects a reference received through the embedded fieldbus interface as speed reference 1.
<i>22.18 Ext2 speed ref1</i>	<i>EFB ref1</i>	Selects a reference received through the embedded fieldbus interface as speed reference 2.

TORQUE REFERENCE SELECTION		
<i>26.11 Torque ref1 source</i>	<i>EFB ref1</i>	Selects a reference received through the embedded fieldbus interface as torque reference 1.
<i>26.12 Torque ref2 source</i>	<i>EFB ref1</i>	Selects a reference received through the embedded fieldbus interface as torque reference 2.

FREQUENCY REFERENCE SELECTION		
<i>28.11 Ext1 frequency ref1</i>	<i>EFB ref1</i>	Selects a reference received through the embedded fieldbus interface as frequency reference 1.

Parameter	Setting for fieldbus control	Function/Information
<i>28.15 Ext2 frequency ref1</i>	<i>EFB ref1</i>	Selects a reference received through the embedded fieldbus interface as frequency reference 2.

OTHER SELECTIONS

EFB references can be selected as the source at virtually any signal selector parameter by selecting *Other*, then either *03.09 EFB reference 1* or *03.10 EFB reference 2*.

SYSTEM CONTROL INPUTS

<i>96.07 Parameter save manually</i>	<i>Save</i> (reverts to <i>Done</i>)	Saves parameter value changes (including those made through fieldbus control) to permanent memory.
--------------------------------------	---------------------------------------	--

■ Basics of the embedded fieldbus interface

The cyclic communication between a fieldbus system and the drive consists of 16-bit data words or 32-bit data words (with a transparent control profile).

The diagram below illustrates the operation of the embedded fieldbus interface. The signals transferred in the cyclic communication are explained further below the diagram.

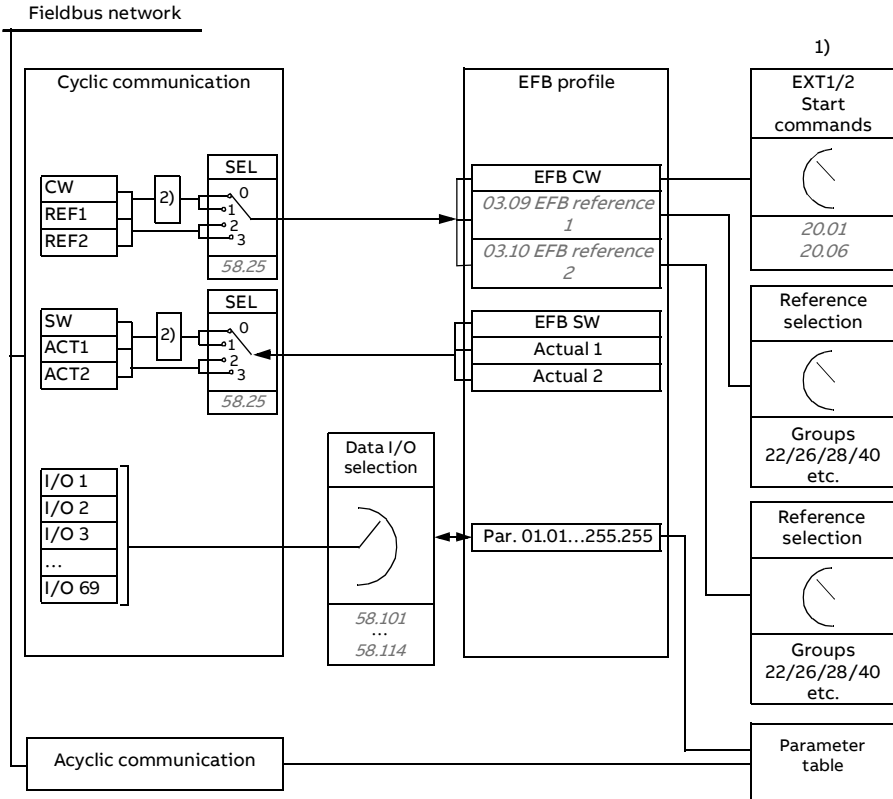

1. See also other parameters which can be controlled through fieldbus.
2. Data conversion if parameter *58.25 Control profile* is set to *ABB Drives*. See section *About the control profiles* on page 386.

■ Control word and Status word

The Control Word (CW) is a 16-bit or 32-bit packed boolean word. It is the principal means of controlling the drive from a fieldbus system. The CW is sent by the fieldbus controller to the drive. With drive parameters, the user selects

the EFB CW as the source of drive control commands (such as start/stop, emergency stop, selection between external control locations 1/2, or fault reset). The drive switches between its states according to the bit-coded instructions of the CW.

The fieldbus CW is either written to the drive as it is or the data is converted. See section *About the control profiles* on page 386.

The fieldbus Status Word (SW) is a 16-bit or 32-bit packed boolean word. It contains status information from the drive to the fieldbus controller. The drive SW is either written to the fieldbus SW as it is or the data is converted. See section *About the control profiles* on page 386.

■ References

EFB references 1 and 2 are 16-bit or 32-bit signed integers. The contents of each reference word can be used as the source of virtually any signal, such as the speed, frequency, torque or process reference. In embedded fieldbus communication, references 1 and 2 are displayed by *03.09 EFB reference 1* and *03.10 EFB reference 2* respectively. Whether the references are scaled or not depends on the settings of *58.26 EFB ref1 type* and *58.27 EFB ref2 type*. See section *About the control profiles* on page 386.

■ Actual values

Fieldbus actual signals (ACT1 and ACT2) are 16-bit or 32-bit signed integers. They convey selected drive parameter values from the drive to the master. Whether the actual values are scaled or not depends on the settings of *58.28 EFB act1 type* and *58.29 EFB act2 type*. See section *About the control profiles* on page 386.

■ Data input/outputs

Data input/outputs are 16-bit or 32-bit words containing selected drive parameter values. Parameters *58.101 Data I/O 1 ... 58.114 Data I/O 14* define the addresses from which the master either reads data (input) or to which it writes data (output).

■ Register addressing

The address field of Modbus requests for accessing holding registers is 16 bits. This allows the Modbus protocol to support addressing of 65536 holding registers.

Historically, Modbus master devices used 5-digit decimal addresses from 40001 to 49999 to represent holding register addresses. The 5-digit decimal addressing limited to 9999 the number of holding registers that could be addressed.

Modern Modbus master devices typically provide a means to access the full range of 65536 Modbus holding registers. One of these methods is to use 6-digit decimal addresses from 400001 to 465536. This manual uses 6-digit decimal addressing to represent Modbus holding register addresses.

Modbus master devices that are limited to the 5-digit decimal addressing may still access registers 400001 to 409999 by using 5-digit decimal addresses 40001 to 49999. Registers 410000-465536 are inaccessible to these masters. For more information, see parameter *58.33 Addressing mode*.

Note: Register addresses of 32-bit parameters cannot be accessed by using 5-digit register numbers.

■ About the control profiles

A control profile defines the rules for data transfer between the drive and the fieldbus master, for example:

- if packed boolean words are converted and how
- if signal values are scaled and how
- how drive register addresses are mapped for the fieldbus master.

You can configure the drive to receive and send messages according to one of the two profiles:

- *ABB Drives*
- *DCU Profile*.

For the ABB Drives profile, the embedded fieldbus interface of the drive converts the fieldbus data to and from the native data used in the drive. The DCU Profile involves no data conversion or scaling. The figure below illustrates the effect of the profile selection.

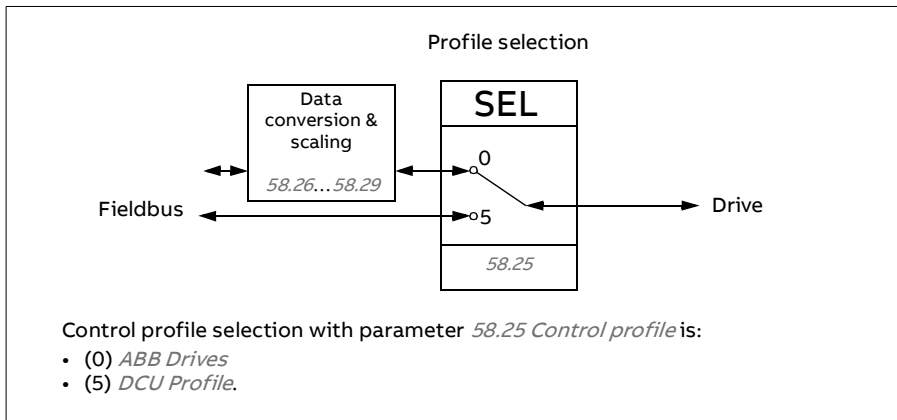

■ Control Word

Control Word for the ABB Drives profile

The table below shows the contents of the fieldbus Control Word for the ABB Drives control profile. The embedded fieldbus interface converts this word to the form in which it is used in the drive. The upper case boldface text refers to the states shown in *State transition diagram for the ABB Drives profile* on page 393.

Bit	Name	Value	STATE/Description
0	OFF1_CONTROL	1	Proceed to READY TO OPERATE .
		0	Stop along currently active deceleration ramp. Proceed to OFF1 ACTIVE ; proceed to READY TO SWITCH ON unless other interlocks (OFF2, OFF3) are active.
1	OFF2_CONTROL	1	Continue operation (OFF2 inactive).
		0	Emergency OFF, coast to stop. Proceed to OFF2 ACTIVE , proceed to SWITCH-ON INHIBITED .
2	OFF3_CONTROL	1	Continue operation (OFF3 inactive).
		0	Emergency stop, stop within time defined by drive parameter. Proceed to OFF3 ACTIVE ; proceed to SWITCH-ON INHIBITED . Warning: Ensure that the motor and driven machine can be stopped using this stop mode.
3	INHIBIT_OPERATION	1	Proceed to OPERATION ENABLED . Note: Run enable signal must be active; see the drive documentation. If the drive is set to receive the Run enable signal from the fieldbus, this bit activates the signal. See also parameter <i>06.18 Start inhibit status word</i> (page 124).
		0	Inhibit operation. Proceed to OPERATION INHIBITED .
4	RAMP_OUT_ZERO	1	Normal operation. Proceed to RAMP FUNCTION GENERATOR: OUTPUT ENABLED .
		0	Force Ramp Function Generator output to zero. Drive ramps to stop (current and DC voltage limits in force).
5	RAMP_HOLD	1	Enable ramp function. Proceed to RAMP FUNCTION GENERATOR: ACCELERATOR ENABLED .
		0	Halt ramping (Ramp Function Generator output held).
6	RAMP_IN_ZERO	1	Normal operation. Proceed to OPERATING . Note: This bit is effective only if the fieldbus interface is set as the source for this signal by drive parameters.
		0	Force Ramp Function Generator input to zero.

Bit	Name	Value	STATE/Description
7	RESET	0=>1	Fault reset if an active fault exists. Proceed to SWITCH-ON INHIBITED . Note: This bit is effective only if the fieldbus interface is set as the source for this signal by drive parameters.
		0	Continue normal operation.
8	JOGGING_1	1	Request running at Jogging 1 speed. Note: This bit is effective only if the fieldbus interface is set as the source for this signal by drive parameters.
		0	Continue normal operation.
9	JOGGING_2	1	Request running at Jogging 2 speed. Note: This bit is effective only if the fieldbus interface is set as the source for this signal by drive parameters.
		0	Continue normal operation.
10	REMOTE_CMD	1	Fieldbus control enabled.
		0	Control Word <> 0 or Reference <> 0: Retain last Control Word and Reference. Control Word = 0 and Reference = 0: Fieldbus control enabled. Reference and deceleration/acceleration ramp are locked.
11	EXT_CTRL_LOC	1	Select External Control Location EXT2. Effective if the control location is parameterized to be selected from the fieldbus.
		0	Select External Control Location EXT1. Effective if the control location is parameterized to be selected from the fieldbus.
12	USER_0		Writable control bits that can be combined with drive logic for application-specific functionality.
13	USER_1		
14	USER_2		
15	USER_3		

■ Control Word for the DCU Profile

The embedded fieldbus interface writes the fieldbus Control Word as is to the drive Control Word bits 0 to 15. Bits 16 to 32 of the drive Control Word are not in use.

Bit	Name	Value	State/Description
0	STOP	1	Stop according to the Stop Mode parameter or the stop mode request bits (bits 7...9).
		0	(no op)
1	START	1	Start the drive.
		0	(no op)

Bit	Name	Value	State/Description
2	REVERSE	1	Reverse direction of motor rotation.
		0	(no op)
3	Reserved		
4	RESET	0=>1	Fault reset if an active fault exists.
		0	(no op)
5	EXT2	1	Select External control location EXT2. Effective if the control location is parameterized to be selected from the fieldbus.
		0	Select External control location EXT1. Effective if the control location is parameterized to be selected from the fieldbus.
6	RUN_DISABLE	1	Run disable. If the drive is set to receive the run enable signal from the fieldbus, this bit deactivates the signal.
		0	Run enable. If the drive is set to receive the run enable signal from the fieldbus, this bit activates the signal.
7	STOPMODE_RAMP	1	Normal ramp stop mode
		0	(no op) Default to parameter stop mode if bits 7...9 are all 0.
8	STOPMODE_EMERGENCY_RAMP	1	Emergency ramp stop mode.
		0	(no op) Default to parameter stop mode if bits 7...9 are all 0.
9	STOPMODE_COAST	1	Coast stop mode.
		0	(no op) Default to parameter stop mode if bits 7...9 are all 0.
10	Reserved for RAMP_PAIR_2		Not yet implemented.
11	RAMP_OUT_ZERO	1	Force Ramp Function Generator output to zero. Drive ramps to stop (current and DC voltage limits in force).
		0	Normal operation.
12	RAMP_HOLD	1	Halt ramping (Ramp Function Generator output held).
		0	Normal operation.
13	RAMP_IN_ZERO	1	Force Ramp Function Generator input to zero.
		0	Normal operation.
14	REQ_LOCAL_LOCK	1	
		0	
15	Reserved for TORQ_LIM_PAIR_2		Not yet implemented.
16	FB_LOCAL_CTL	1	Local mode for control from the fieldbus is requested. Steal control from the active source.
		0	(no op)

Bit	Name	Value	State/Description
17	FB_LOCAL_REF	1	Local mode for reference from the fieldbus is requested. Steal reference from the active source.
		0	(no op)
18	Reserved for RUN_DISABLE_1		Not yet implemented.
19	Reserved		
20	Reserved		
21	Reserved		
22	USER_0		Writable control bits that can be combined with drive logic for application-specific functionality.
23	USER_1		
24	USER_2		
25	USER_3		
26 ...31	Reserved		

■ Status Word

Status Word for the ABB Drives profile

The table below shows the fieldbus Status Word for the ABB Drives control profile. The embedded fieldbus interface converts the drive Status Word into this form for the fieldbus. The upper case boldface text refers to the states shown in *State transition diagram for the ABB Drives profile* on page 393.

Bit	Name	Value	STATE/Description
0	RDY_ON	1	READY TO SWITCH ON.
		0	NOT READY TO SWITCH ON.
1	RDY_RUN	1	READY TO OPERATE.
		0	OFF1 ACTIVE.
2	RDY_REF	1	OPERATION ENABLED.
		0	OPERATION INHIBITED. See also parameter <i>06.18 Start inhibit status word</i> (page 124).
3	TRIPPED	1	FAULT.
		0	No fault.
4	OFF_2_STATUS	1	OFF2 inactive.
		0	OFF2 ACTIVE.
5	OFF_3_STATUS	1	OFF3 inactive.
		0	OFF3 ACTIVE.
6	SWC_ON_INHIB	1	SWITCH-ON INHIBITED.
		0	–

Bit	Name	Value	STATE/Description
7	ALARM	1	Warning/Alarm.
		0	No warning/alarm.
8	AT_SETPOINT	1	OPERATING. Actual value equals Reference (is within tolerance limits, e.g. in speed control, speed error is 10% max. of nominal motor speed).
		0	Actual value differs from Reference (is outside tolerance limits).
9	REMOTE	1	Drive control location: REMOTE (EXT1 or EXT2).
		0	Drive control location: LOCAL.
10	ABOVE_LIMIT	1	Actual frequency or speed equals or exceeds supervision limit (set by drive parameter). Valid in both directions of rotation. Set by drive parameters: <i>46.31, 46.32, 46.33</i> . These parameters are indicated by bit 10 of <i>06.11 Main status word</i> .
		0	Actual frequency or speed within supervision limit.
11	USER_0		Status bits that can be combined with drive logic for application-specific functionality.
12	USER_1		
13	USER_2		
14	USER_3		
15	Reserved		

Status Word for the DCU Profile

The embedded fieldbus interface writes the drive Status Word bits 0 to 15 to the fieldbus Status Word as is. Bits 16 to 32 of the drive Status Word are not in use.

Bit	Name	Value	State/Description
0	READY	1	Drive is ready to receive the start command.
		0	Drive is not ready.
1	ENABLED	1	External run enable signal is active.
		0	External run enable signal is not active.
2	Reserved for ENABLED_TO_ROTATE		Not yet implemented.
3	RUNNING	1	Drive is modulating.
		0	Drive is not modulating.
4	ZERO_SPEED	1	Drive is at zero speed.
		0	Drive is not at zero speed.
5	ACCELERATING	1	Not yet implemented.
		0	Not yet implemented.

Bit	Name	Value	State/Description
6	DECELERATING	1	Not yet implemented.
		0	Not yet implemented.
7	AT_SETPOINT	1	Drive is at setpoint.
		0	Drive is not at setpoint.
8	LIMIT	1	Drive operation is limited.
		0	Drive operation is not limited.
9	SUPERVISION	1	Actual value (speed, frequency or torque) is above a limit. Limit is set with parameters 46.31...46.33
		0	Actual value (speed, frequency or torque) is within limits.
10	REVERSE_REF	1	Not yet implemented.
		0	Not yet implemented.
11	REVERSE_ACT	1	Not yet implemented.
		0	Not yet implemented.
12	PANEL_LOCAL	1	Panel/keypad (or PC tool) is in local control mode.
		0	Panel/keypad (or PC tool) is not in local control mode.
13	FIELDBUS_LOCAL	1	Fieldbus is in local control mode.
		0	Fieldbus is not in local control mode.
14	EXT2_ACT	1	External control location EXT2 is active.
		0	External control location EXT1 is active.
15	FAULT	1	Drive is faulted.
		0	Drive is not faulted.
16	ALARM	1	Warning/Alarm is active.
		0	No warning/alarm.
17	Reserved		
18	Reserved for DIRECTION_LOCK		Not yet implemented.
19	Reserved		
20	CTL_MODE	1	Vector motor control mode is active.
		0	Scalar motor control mode is active
21	Reserved		
22	USER_0		Status bits that can be combined with drive logic for application-specific functionality.
23	USER_1		
24	USER_2		
25	USER_3		
26	REQ_CTL	1	Control is requested in this channel.
		0	Control is not requested in this channel.

Bit	Name	Value	State/Description
27 ... 31	Reserved		

■ State transition diagrams

State transition diagram for the ABB Drives profile

The diagram below shows the state transitions in the drive when the drive is using the ABB Drives profile and the drive is configured to follow the commands of the control word from the embedded fieldbus interface. The upper case texts refer to the states which are used in the tables representing the fieldbus Control and Status words.

See sections *Control Word for the ABB Drives profile* on page 387 and *Status Word for the ABB Drives profile* on page 390.

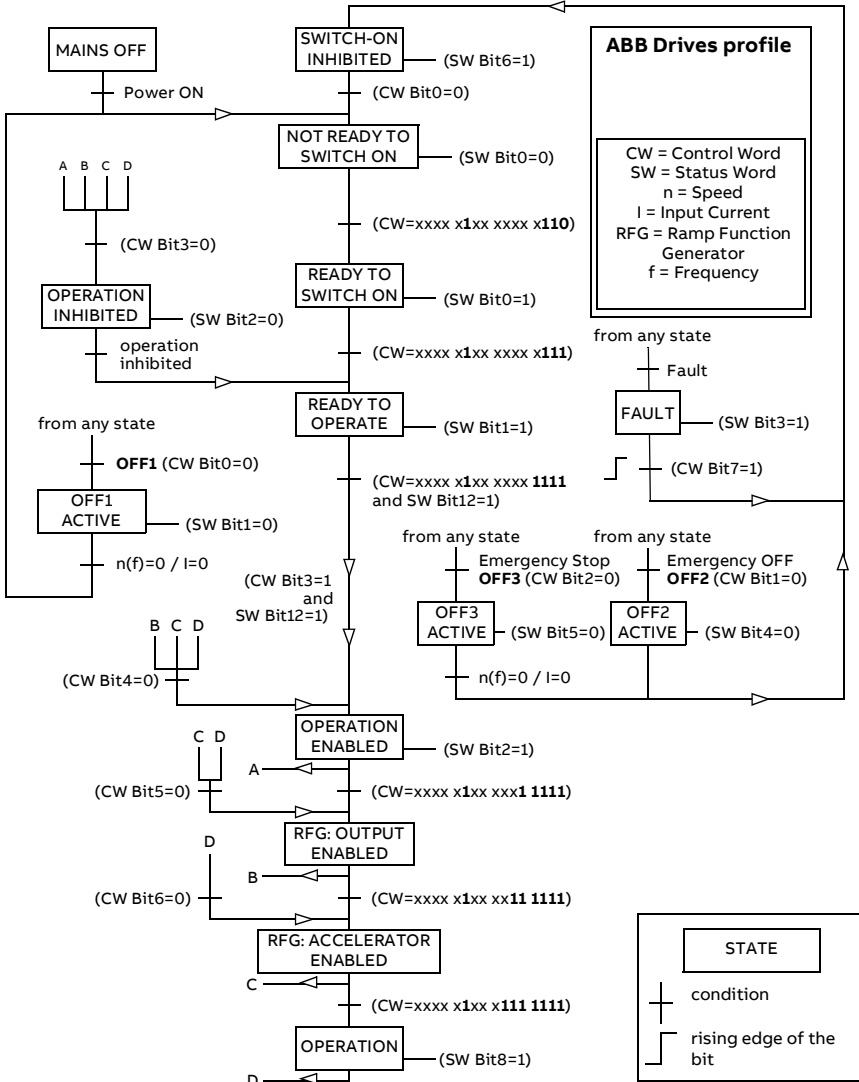

A control word sequence example is given below:

Start:

- 476h --> NOT READY TO SWITCH ON

If MSW bit 0 = 1 then

- 477h --> READY TO SWITCH ON (Stopped)
- 47Fh --> OPERATION (Running)

Stop:

- 477h = Stop according to *21.03 Stop mode*
- 47Eh = OFF1 ramp stop (**Note:** uninterpretable ramp stop)

Fault reset:

- Rising edge of MCW bit 7

Start after STO:

If *31.22 STO indication run/stop* is not *Fault/Fault* make sure that *06.18 Start inhibit status word*, bit 7 STO = 0 before giving a start command.

■ References

References for the ABB Drives profile and DCU Profile

The ABB Drives profile supports the use of two references, EFB reference 1 and EFB reference 2. The references are 16-bit words each containing a sign bit and a 15-bit integer. A negative reference is formed by calculating the two's complement from the corresponding positive reference.

The references are scaled as defined by parameters *46.01...46.04*; which scaling is in use depends on the setting of *58.26 EFB ref1 type* and *58.27 EFB ref2 type* (see page *286*).

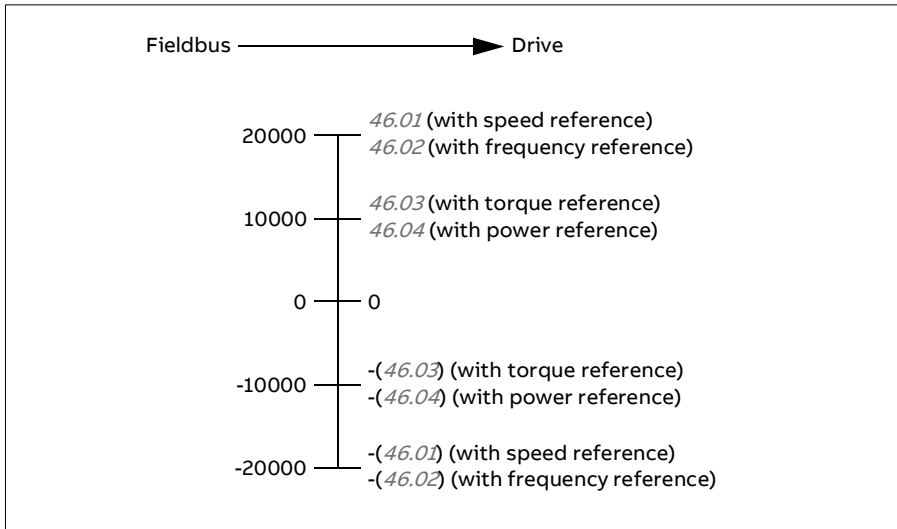

The scaled references are shown by parameters *03.09 EFB reference 1* and *03.10 EFB reference 2*.

■ Actual values

Actual values for the ABB Drives profile and DCU Profile

The ABB Drives profile supports the use of two fieldbus actual values, ACT1 and ACT2. The actual values are 16-bit words each containing a sign bit and a 15-bit integer. A negative value is formed by calculating the two's complement from the corresponding positive value.

The actual values are scaled as defined by parameters *46.01...46.04*; which scaling is in use depends on the setting of parameters *58.28 EFB act1 type* and *58.29 EFB act2 type* (see page *286*).

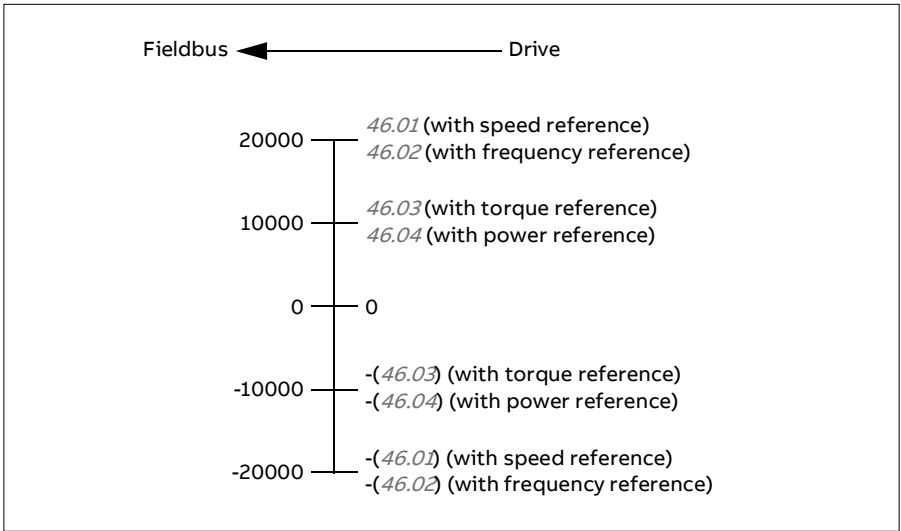

■ **Modbus holding register addresses**

Modbus holding register addresses for the ABB Drives profile and DCU Profile

The table below shows the default Modbus holding register addresses for the drive data with the ABB Drives profile. This profile provides a converted 16-bit access to the drive data.

Note: Only the 16 least significant bits of the drive’s 32-bit Control and Status Words can be accessed.

Note: Bits 16 through 32 of the DCU Control/Status word are not in use if 16-bit control/status word is used with the DCU Profile.

Register address	Register data (16-bit words)
400001	Default: Control word (<i>CW 16bit</i>). See sections <i>Control Word for the ABB Drives profile</i> (page 387) and <i>Control Word for the DCU Profile</i> (page 388). The selection can be changed using parameter 58.101 Data I/O 1.
400002	Default: Reference 1 (<i>Ref1 16bit</i>). The selection can be changed using parameter 58.102 Data I/O 2.
400003	Default: Reference 2 (<i>Ref2 16bit</i>). The selection can be changed using parameter 58.102 Data I/O 2.
400004	Default: Status Word (<i>SW 16bit</i>). See sections <i>Status Word for the ABB Drives profile</i> (page 390) and <i>Status Word for the DCU Profile</i> (page 391). The selection can be changed using parameter 58.102 Data I/O 2.

400005	Default: Actual value 1 (<i>Act1 16bit</i>). The selection can be changed using parameter <i>58.105 Data I/O 5</i> .
400006	Actual value 2 (<i>Act2 16bit</i>). The selection can be changed using parameter <i>58.106 Data I/O 6</i> .
400007...400014	Data in/out 7...14. Selected by parameters <i>58.107 Data I/O 7... 58.114 Data I/O 14</i> .
400015...400089	Unused
400090...400100	Error code access. See section <i>Error code registers (holding registers 400090...400100)</i> (page 402).
400101...465536	Parameter read/write. Parameters are mapped to register addresses according to parameter <i>58.33 Addressing mode</i> .

■ Modbus function codes

The table below shows the Modbus function codes supported by the embedded fieldbus interface.

Code	Function name	Description
01h	Read Coils	Reads the 0/1 status of coils (0X references).
02h	Read Discrete Inputs	Reads the 0/1 status of discrete inputs (1X references).
03h	Read Holding Registers	Reads the binary contents of holding registers (4X references).
05h	Write Single Coil	Forces a single coil (0X reference) to 0 or 1.
06h	Write Single Register	Writes a single holding register (4X reference).
08h	Diagnostics	Provides a series of tests for checking the communication, or for checking various internal error conditions. Supported subcodes: <ul style="list-style-type: none"> • 00h Return Query Data: Echo/loopback test. • 01h Restart Comm Option: Restarts and initializes the EFB, clears communications event counters. • 04h Force Listen Only Mode • 0Ah Clear Counters and Diagnostic Register • 0Bh Return Bus Message Count • 0Ch Return Bus Comm. Error Count • 0Dh Return Bus Exception Error Count • 0Eh Return Slave Message Count • 0Fh Return Slave No Response Count • 10h Return Slave NAK (negative acknowledge) Count • 11h Return Slave Busy Count • 12h Return Bus Character Overrun Count • 14h Clear Overrun Counter and Flag

Code	Function name	Description
08h	Get Comm Event Counter	Returns a status word and an event count.
0Fh	Write Multiple Coils	Forces a sequence of coils (0X references) to 0 or 1.
10h	Write Multiple Registers	Writes the contents of a contiguous block of holding registers (4X references).
16h	Mask Write Register	Modifies the contents of a 4X register using a combination of an AND mask, an OR mask, and the register's current contents.
17h	Read/Write Multiple Registers	Writes the contents of a contiguous block of 4X registers, then reads the contents of another group of registers (the same or different than those written) in a server device.
2Bh / 0Eh	Encapsulated Interface Transport	Supported subcodes: <ul style="list-style-type: none"> • 0Eh Read Device Identification: Allows reading the identification and other information. Supported ID codes (access type): <ul style="list-style-type: none"> • 00h: Request to get the basic device identification (stream access) • 04h: Request to get one specific identification object (individual access) Supported Object IDs: <ul style="list-style-type: none"> • 00h: Vendor Name ("ABB") • 01h: Product Code (for example, "ASCCL") • 02h: Major Minor Revision (combination of contents of parameters <i>07.05 Firmware version</i> and <i>58.02 Protocol ID</i>). • 03h: Vendor URL ("www.abb.com") • 04h: Product name: ("ACS180").

■ Exception codes

The table below shows the Modbus exception codes supported by the embedded fieldbus interface.

Code	Name	Description
01h	ILLEGAL FUNCTION	The function code received in the query is not an allowable action for the server.
02h	ILLEGAL ADDRESS	The data address received in the query is not an allowable address for the server.
03h	ILLEGAL VALUE	The requested quantity of registers is larger than the device can handle. This error does not mean that a value written to the device is outside of the valid range.

Code	Name	Description
04h	DEVICE FAILURE	An unrecoverable error occurred while the server was attempting to perform the requested action. See section <i>Error code registers (holding registers 400090...400100)</i> on page 402.

■ Coils (0xxxx reference set)

Coils are 1-bit read/write values. Control Word bits are exposed with this data type. The table below summarizes the Modbus coils (0xxxx reference set). Note that the references are 1-based index which match the address transmitted on the wire.

Reference	ABB Drives profile	DCU Profile
000001	OFF1_CONTROL	STOP
000002	OFF2_CONTROL	START
000003	OFF3_CONTROL	Reserved
000004	INHIBIT_OPERATION	Reserved
000005	RAMP_OUT_ZERO	RESET
000006	RAMP_HOLD	EXT2
000007	RAMP_IN_ZERO	RUN_DISABLE
000008	RESET	STOPMODE_RAMP
000009	JOGGING_1	STOPMODE_EMERGENCY_RAMP
000010	JOGGING_2	STOPMODE_COAST
000011	REMOTE_CMD	Reserved
000012	EXT_CTRL_LOC	RAMP_OUT_ZERO
000013	USER_0	RAMP_HOLD
000014	USER_1	RAMP_IN_ZERO
000015	USER_2	Reserved
000016	USER_3	Reserved
000017	Reserved	FB_LOCAL_CTL
000018	Reserved	FB_LOCAL_REF
000019	Reserved	Reserved
000020	Reserved	Reserved
000021	Reserved	CTL_MODE
000022	Reserved	Reserved
000023	Reserved	USER_0
000024	Reserved	USER_1
000025	Reserved	USER_2
000026	Reserved	USER_3
000027	Reserved	Reserved
000028	Reserved	Reserved

Reference	ABB Drives profile	DCU Profile
000029	Reserved	Reserved
000030	Reserved	Reserved
000031	Reserved	Reserved
000032	Reserved	Reserved
000033	Control for relay output RO1 (parameter <i>10.99 RO/DIO control word</i> , bit 0)	Control for relay output RO1 (parameter <i>10.99 RO/DIO control word</i> , bit 0)

■ Discrete inputs (1xxxx reference set)

Discrete inputs are 1-bit read-only values. Status Word bits are exposed with this data type. The table below summarizes the Modbus discrete inputs (1xxxx reference set). Note that the references are 1-based index which match the address transmitted on the wire.

Reference	ABB Drives profile	DCU Profile
0	RDY_ON	READY
1	RDY_RUN	ENABLED
2	RDY_REF	Reserved
3	TRIPPED	RUNNING
4	OFF_2_STATUS	ZERO_SPEED
5	OFF_3_STATUS	Reserved
6	SWC_ON_INHIB	Reserved
7	ALARM	AT_SETPOINT
8	AT_SETPOINT	LIMIT
9	REMOTE	SUPERVISION
10	ABOVE_LIMIT	Reserved
11	USER_0	Reserved
12	USER_1	PANEL_LOCAL
13	USER_2	FIELDBUS_LOCAL
14	USER_3	EXT2_ACT
15	Reserved	FAULT
16	Reserved	ALARM
17	Reserved	Reserved
18	Reserved	Reserved
19	Reserved	Reserved
20	Reserved	Reserved
21	Reserved	Reserved
22	Reserved	USER_0
23	Reserved	USER_1

Reference	ABB Drives profile	DCU Profile
24	Reserved	USER_2
25	Reserved	USER_3
26	Reserved	REQ_CTL
27	Reserved	Reserved
28	Reserved	Reserved
29	Reserved	Reserved
30	Reserved	Reserved
31	Reserved	Reserved
32	Delayed status of digital input DI1 (parameter <i>10.02 DI delayed status</i> , bit 0)	Delayed status of digital input DI1 (parameter <i>10.02 DI delayed status</i> , bit 0)
33	Delayed status of digital input DI2 (parameter <i>10.02 DI delayed status</i> , bit 1)	Delayed status of digital input DI2 (parameter <i>10.02 DI delayed status</i> , bit 1)
34	Delayed status of digital input DI3 (parameter <i>10.02 DI delayed status</i> , bit 2)	Delayed status of digital input DI3 (parameter <i>10.02 DI delayed status</i> , bit 2)
35	Delayed status of digital input DI4 (parameter <i>10.02 DI delayed status</i> , bit 3)	Delayed status of digital input DI4 (parameter <i>10.02 DI delayed status</i> , bit 3)
36	Delayed status of digital input DO1 (parameter <i>11.02 DIO delayed status</i> , bit 4)	Delayed status of digital input DO1 (parameter <i>11.02 DIO delayed status</i> , bit 4)

■ Error code registers (holding registers 400090...400100)

These registers contain information about the last query. The error register is cleared when a query has finished successfully.

Reference	Name	Description
89	Reset Error Registers	1 = Reset internal error registers (91...95). 0 = Do nothing.
90	Error Function Code	Function code of the failed query.
91	Error Code	Set when exception code 04h is generated (see table above). <ul style="list-style-type: none"> • 00h No error • 02h Low/High limit exceeded • 03h Faulty Index: Unavailable index of an array parameter • 05h Incorrect Data Type: Value does not match the data type of the parameter • 65h General Error: Undefined error when handling query

Reference	Name	Description
92	Failed Register	The last register (discrete input, coil, input register or holding register) that failed to be read or written.
93	Last Register Written Successfully	The last register (discrete input, coil, input register or holding register) that was written successfully.
94	Last Register Read Successfully	The last register (discrete input, coil, input register or holding register) that was read successfully.

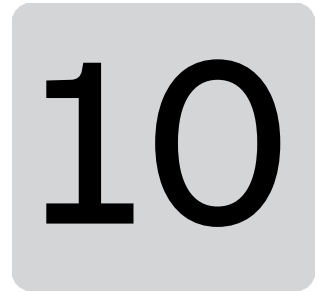

Control chain diagrams

What this chapter contains

This chapter presents the reference chains of the drive. The control chain diagrams can be used to trace how parameters interact and where parameters have an effect within the drive parameter system.

For a more general diagram, see section *Operating modes of the drive* on page 48.

Note: The panel references in the diagrams refer to ACX-AP-x Assistant control panels and the Drive composer PC tool.

Frequency reference selection

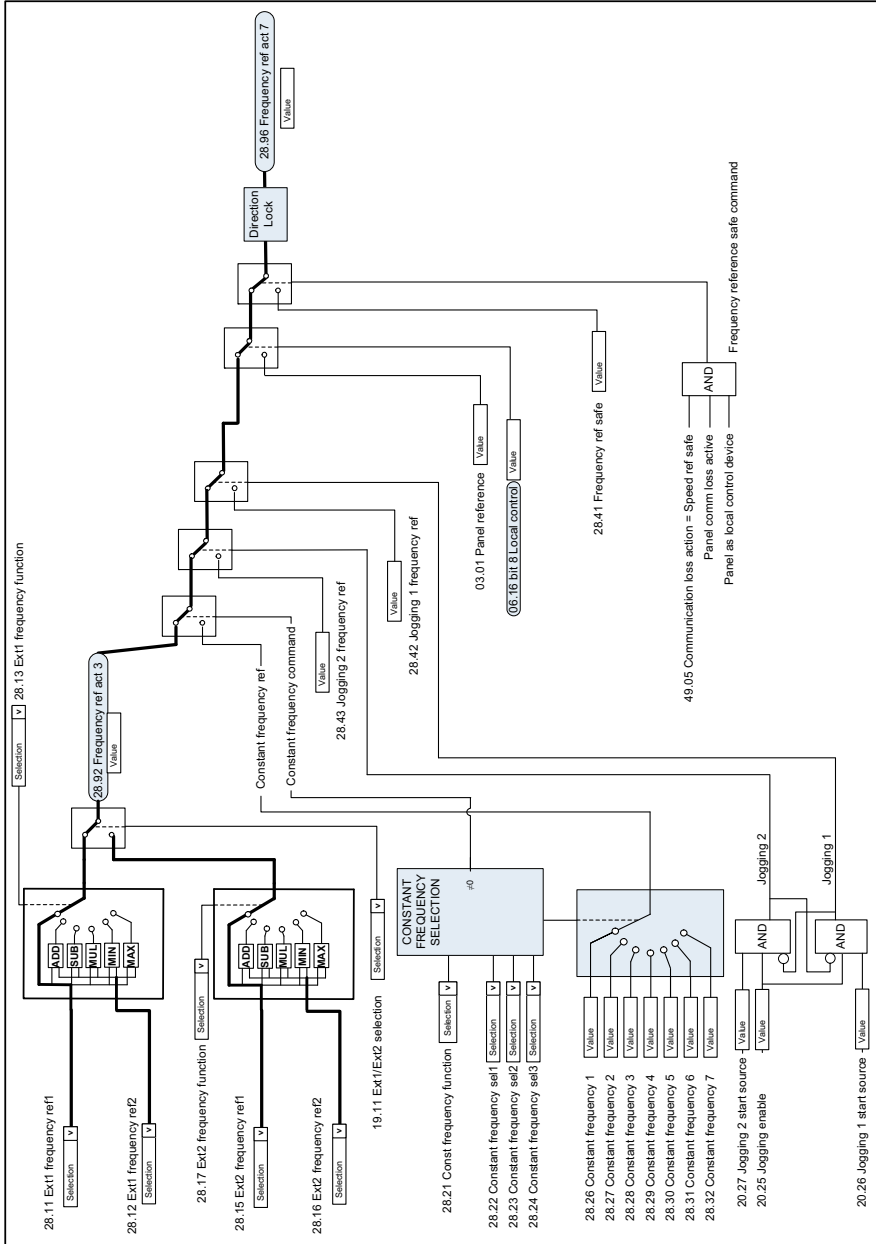

Frequency reference modification

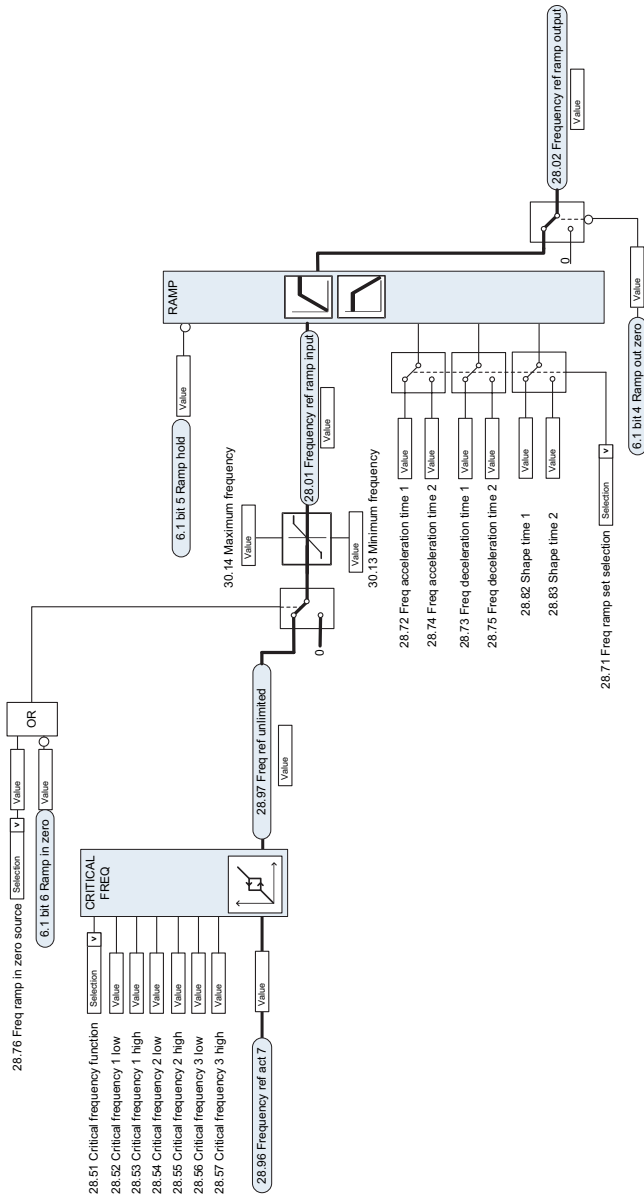

Speed reference source selection I

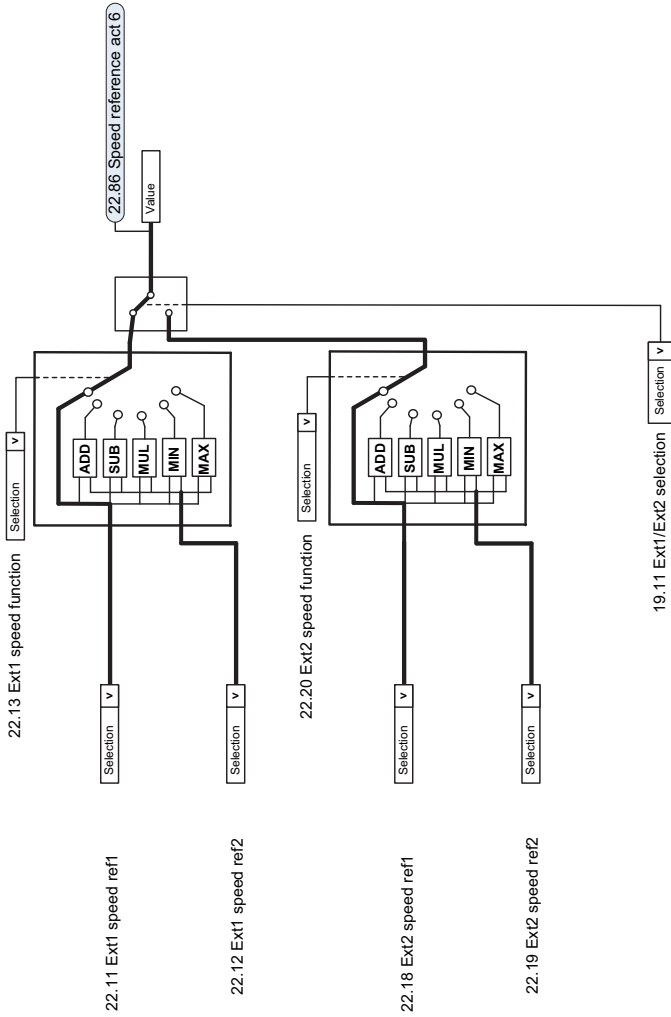

Speed reference source selection II

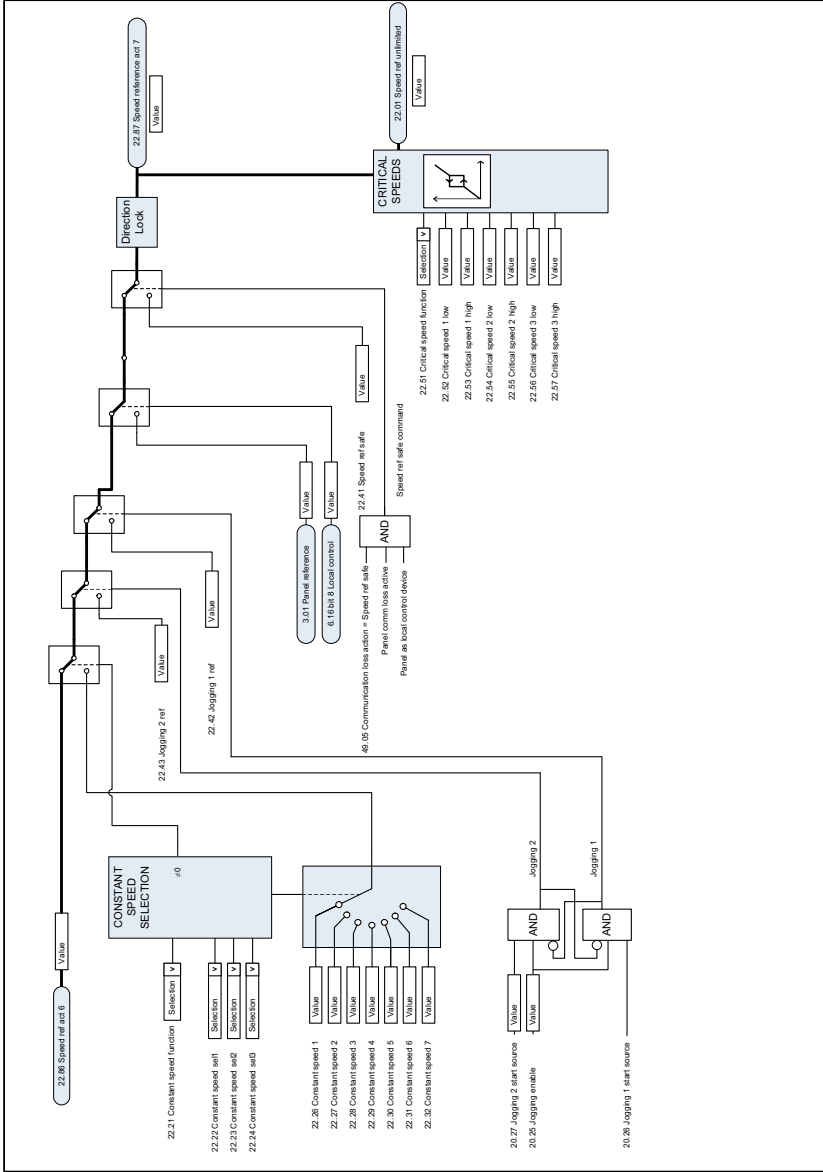

Speed reference ramping and shaping

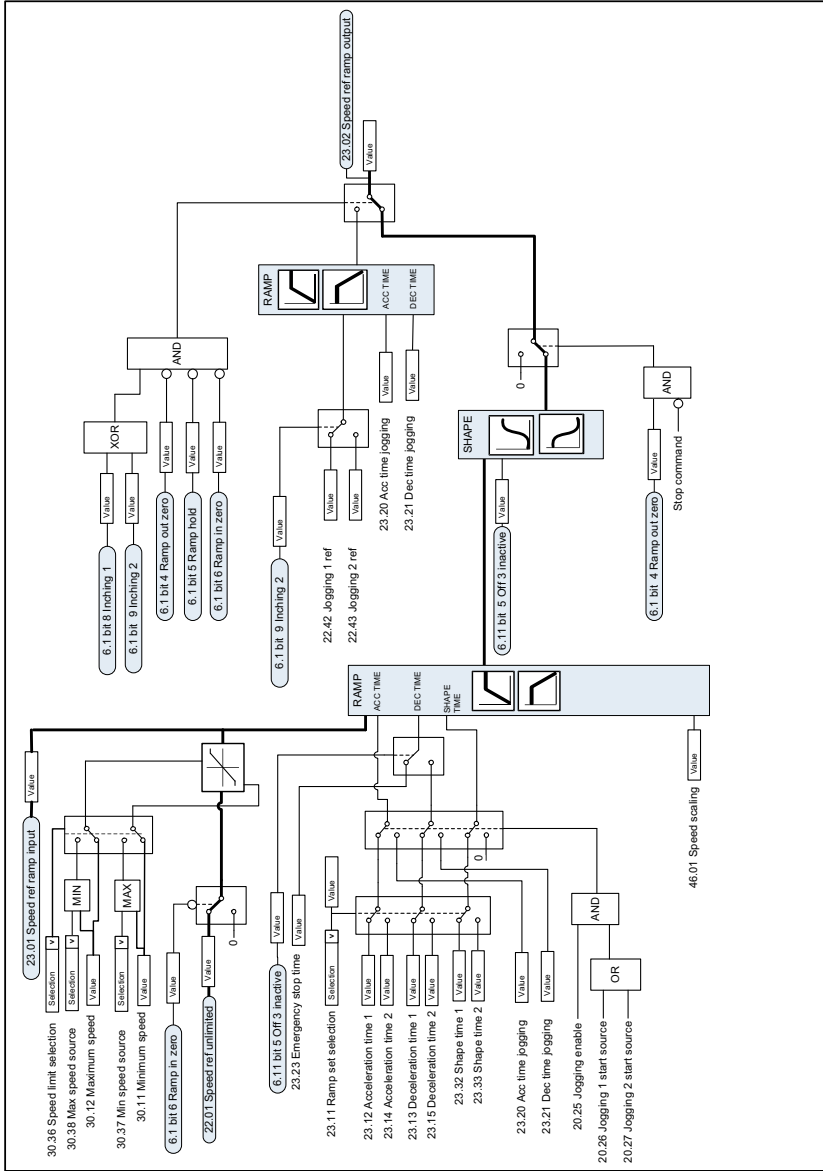

Speed error calculation

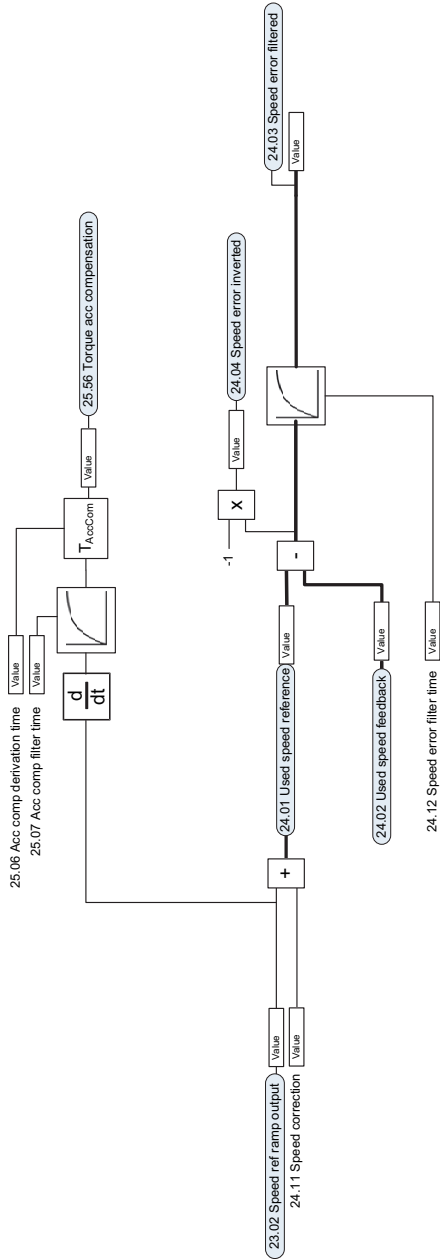

Speed controller

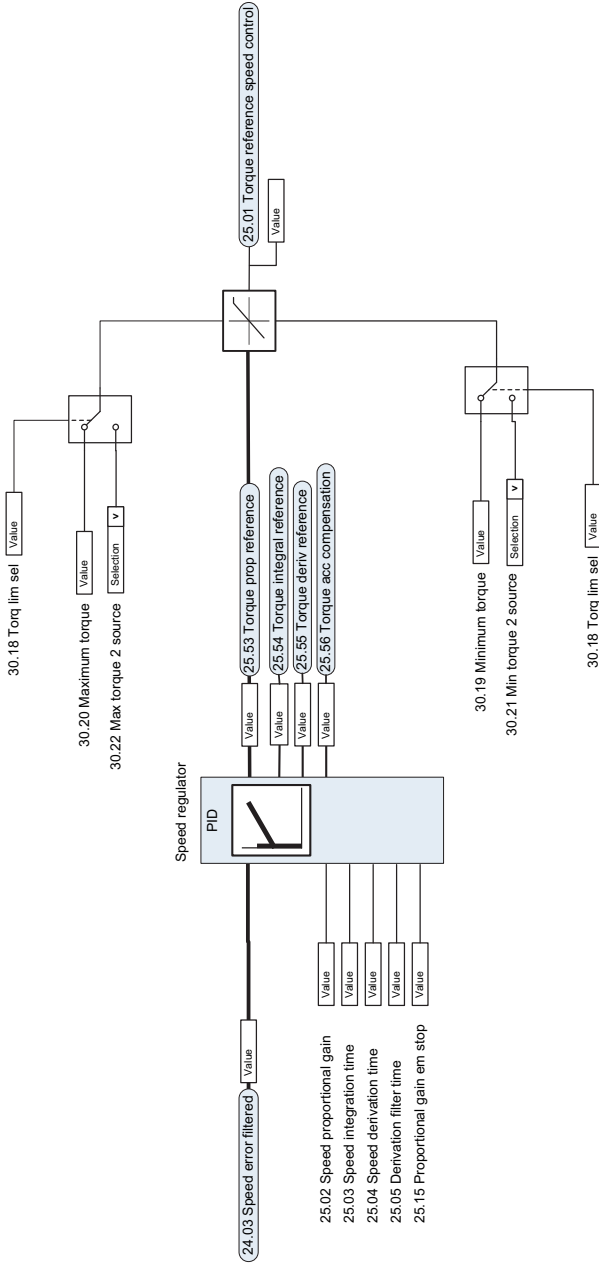

Torque reference source selection and modification

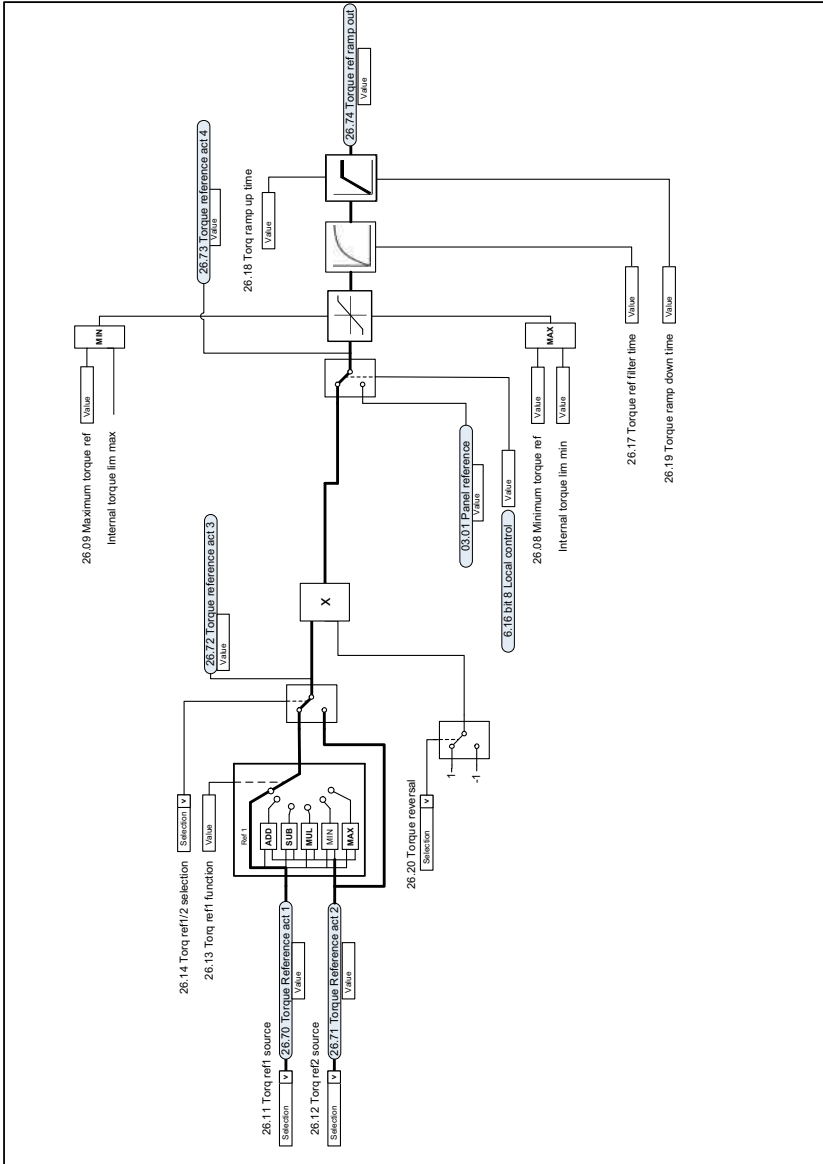

Reference selection for torque controller

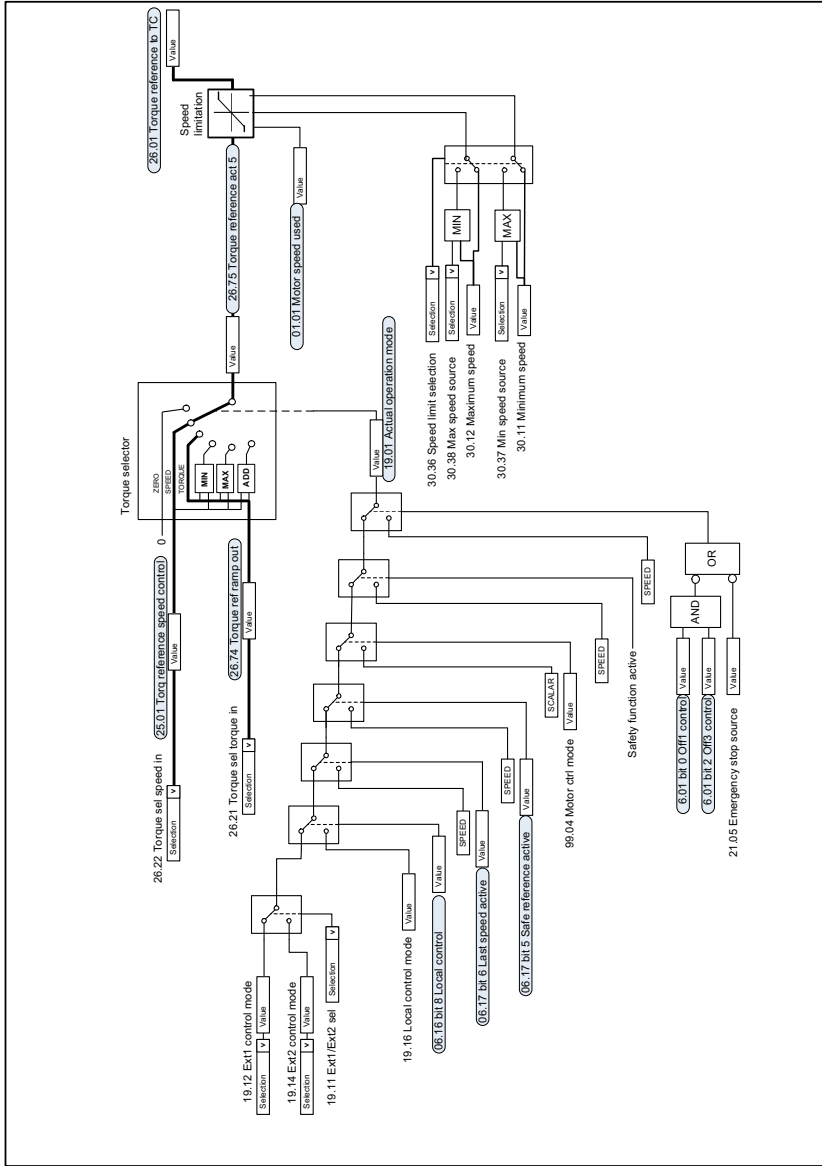

Torque limitation

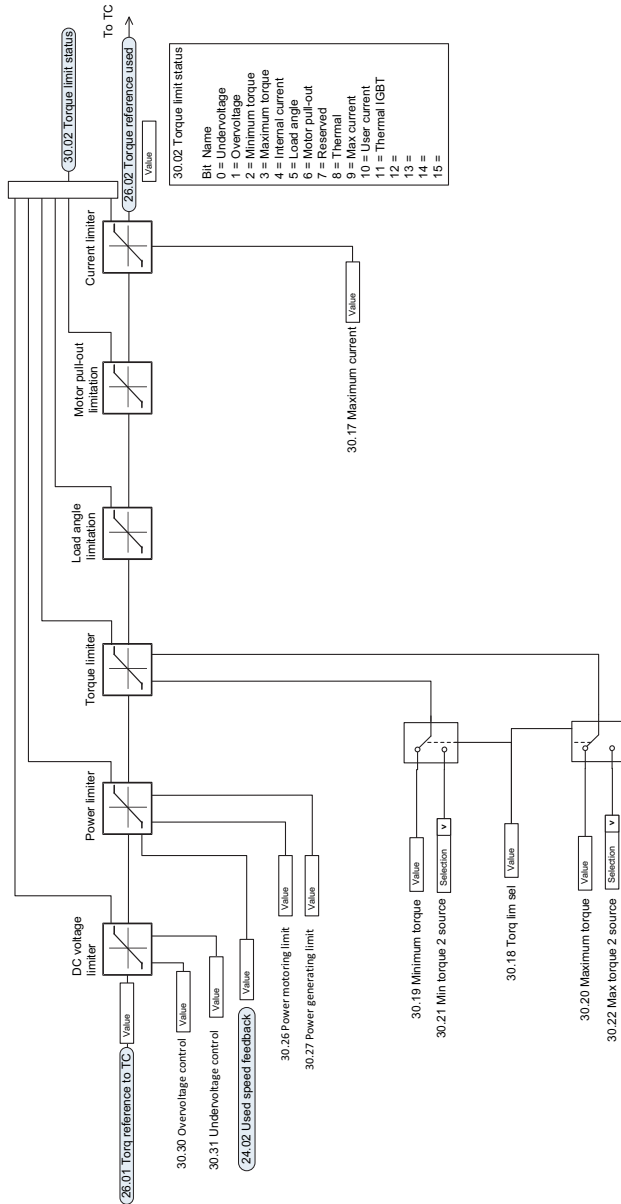

Process PID setpoint and feedback source selection

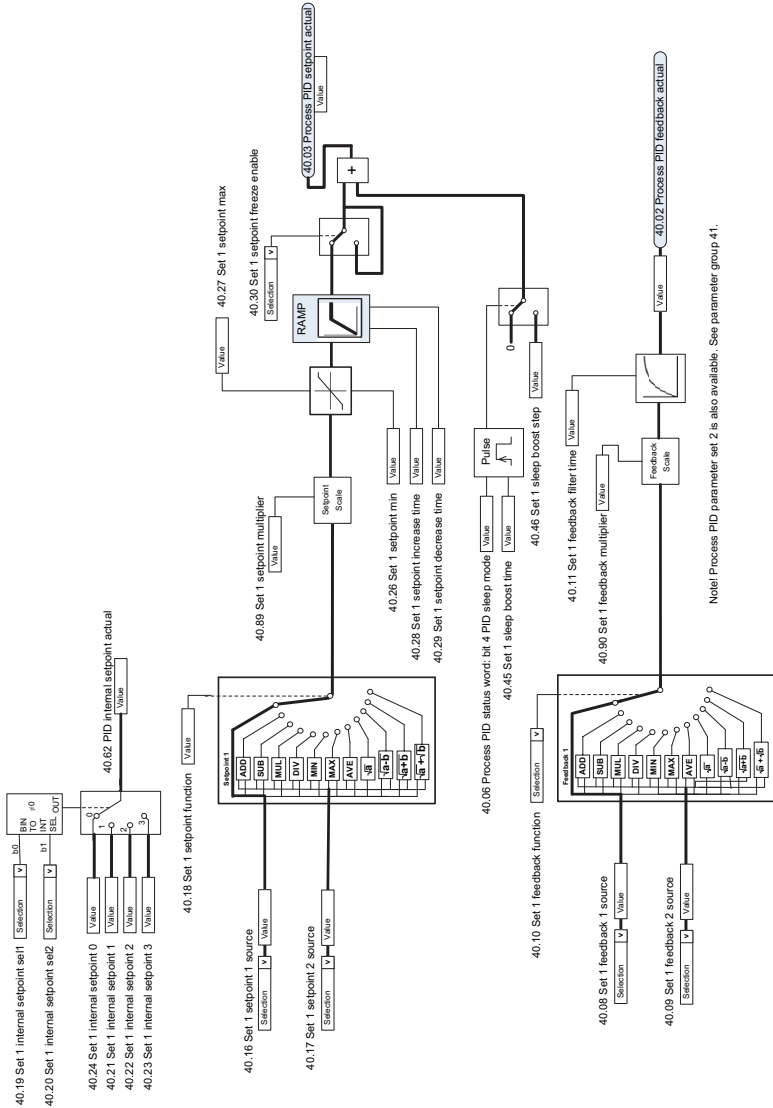

Process PID controller

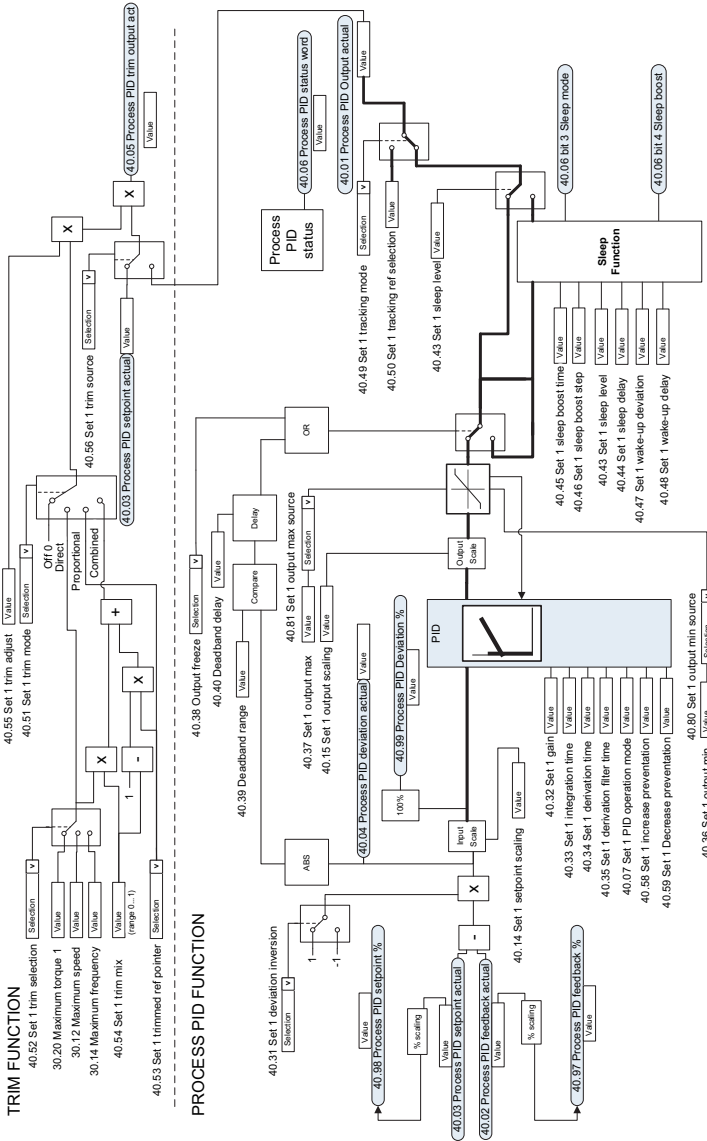

External PID setpoint and feedback source selection

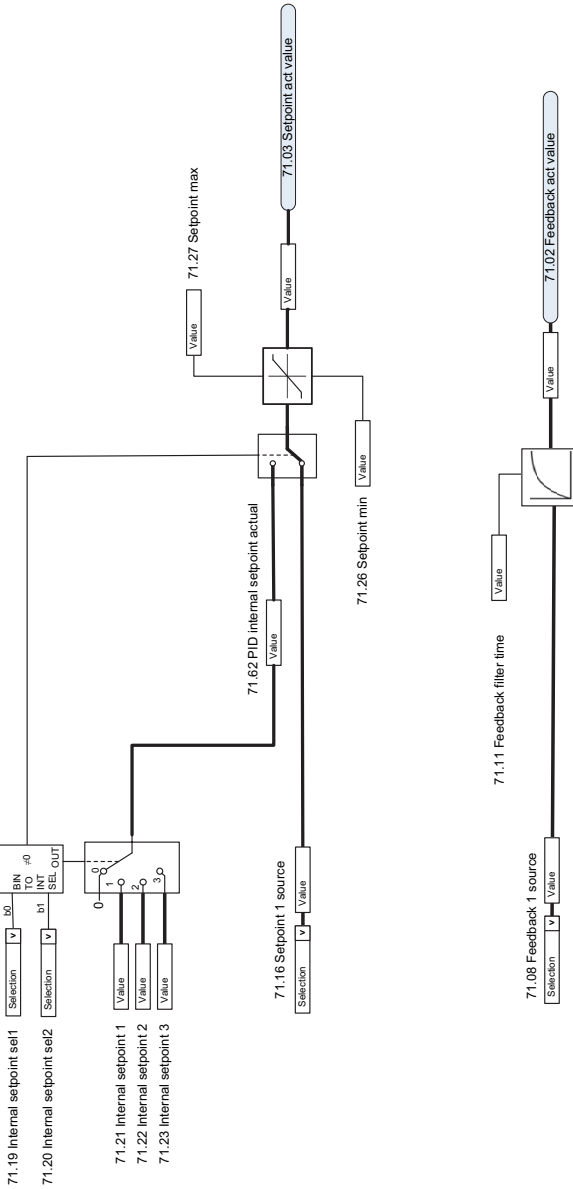

External PID controller

EXTERNAL PID FUNCTION

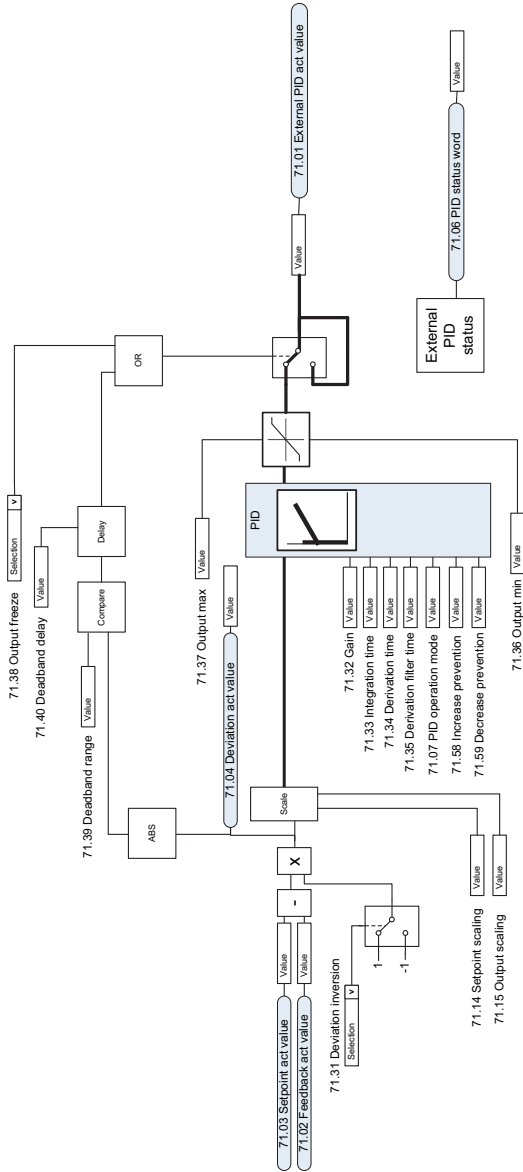

Direction lock

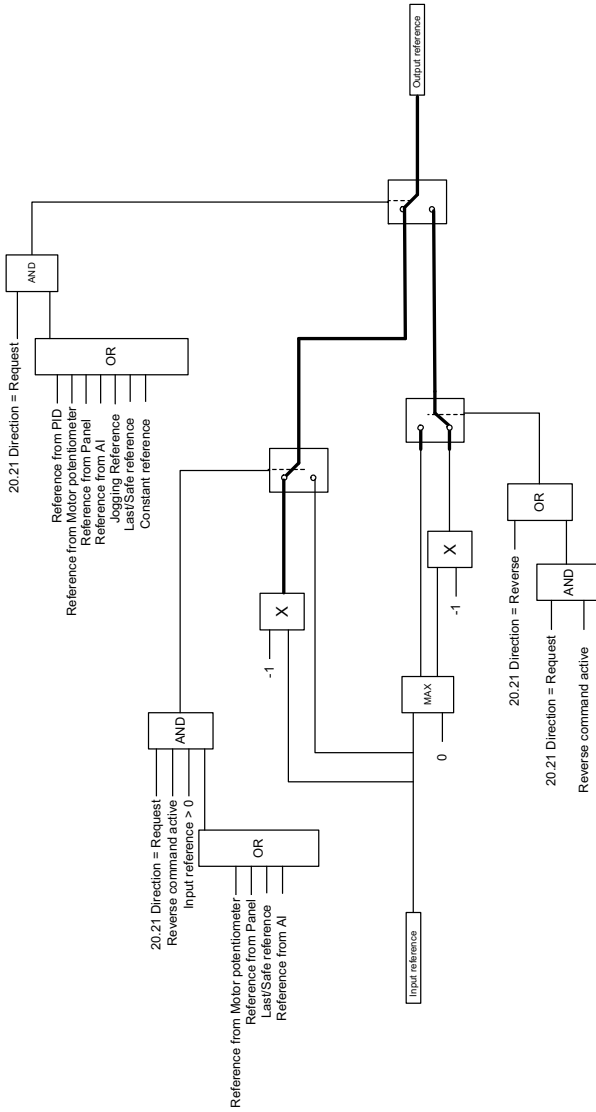

Further information

Product and service inquiries

Address any inquiries about the product to your local ABB representative, quoting the type designation and serial number of the unit in question. A listing of ABB sales, support and service contacts can be found by navigating to abb.com/searchchannels.

Product training

For information on ABB product training, navigate to new.abb.com/service/training.

Providing feedback on ABB Drives manuals

Your comments on our manuals are welcome. Navigate to new.abb.com/drives/manuals-feedback-form.

Document library on the Internet

You can find manuals and other product documents in PDF format on the Internet at abb.com/drives/documents.



abb.com/drives



3AXD50000467860C