

ValveMate 7194 Auger Valve Controller

Operating Manual



Electronic pdf files of Nordson EFD manuals are also available at www.nordsonefd.com



You have selected a reliable, high-quality dispensing system from Nordson EFD, the world leader in fluid dispensing. The ValveMate™ 7194 auger valve controller was designed specifically for industrial dispensing and will provide you with years of trouble-free, productive service.

This manual will help you maximize the usefulness of your ValveMate 7194 controller.

Please spend a few minutes to become familiar with the controls and features. Follow our recommended testing procedures. Review the helpful information we have included, which is based on more than 50 years of industrial dispensing experience.

Most questions you will have are answered in this manual. However, if you need assistance, please do not hesitate to contact EFD or your authorized EFD distributor. Detailed contact information is provided on the last page of this document.

The Nordson EFD Pledge

Thank You!

You have just purchased the world's finest precision dispensing equipment.

I want you to know that all of us at Nordson EFD value your business and will do everything in our power to make you a satisfied customer.

If at any time you are not fully satisfied with our equipment or the support provided by your Nordson EFD Product Application Specialist, please contact me personally at 800.556.3484 (US), 401.431.7000 (outside US), or Srini.Subramanian@nordsonefd.com.

I guarantee that we will resolve any problems to your satisfaction.

Thanks again for choosing Nordson EFD.

Srini Subramanian
Srini Subramanian, General Manager

Contents

Contents	3
Introduction	4
Nordson EFD Product Safety Statement	5
Halogenated Hydrocarbon Solvent Hazards	6
High Pressure Fluids	6
Qualified Personnel	6
Intended Use	7
Regulations and Approvals	7
Personal Safety	7
Fire Safety	8
Preventive Maintenance	8
Important Disposable Component Safety Information	9
Action in the Event of a Malfunction	9
Disposal	9
Specifications	10
Operating Features	11
Front Panel Components	11
Indicator Lamps	11
Back Panel Connections / Markings	12
Front Panel Buttons / Modes of Operation	13
Installation	14
Typical Setup: ValveMate 7194 System with a 794 Valve	14
Typical Setup: ValveMate 7194 System with a 794-TC Valve	15
Mounting the ValveMate 7194 Controller	16
Connecting the External Power Adapter	17
Connecting the Valve Initiate Signal	17
Connecting Inputs / Outputs	18
5–24 INIT Connection	19
Alarm OUT Connection	19
End-of-Cycle (EOC) OUT Connection	19
CC INIT Connection	19
10–24 VDC MOTOR	19
I/O Connection Schematics	20
Connecting Air	21
Air Input Connection	21
Air Output Connection	21
Installing a 794 Auger Valve	22
Installing a 794-TC Auger Valve	23
System Setup Recommendations	24
Testing the Installation	25
How To	26
How to Set the Forward Dispense Time	26
How to Make On-the-Fly (OTF) Time Adjustments in the RUN Mode	26
How to Set the Forward Motor Speed	26
How to Set the Reverse Motor Speed	26
How to Set the Fluid Pressure Air Output Mode	26
How to Set the Auger Valve Type	27
How to Enable / Disable Reverse Motor Rotation	27
How to Use the TEACH Mode	27
How to Purge with or without Fluid Pressure	27
How to Enable / Disable the Steady / Timer Override Mode	28
How to Enable / Disable the Low Air Pressure Alarm	28
How to Select PSI or BAR Pressure Readout	28
How to Enable / Disable CC INIT I/O as an External Alarm Input	28
Valve Type Selection Table	29
Motor / Electrical Short Circuit Alarm	29
Part Numbers	30
Replacement Parts	30
Troubleshooting	31

Introduction

This manual provides installation, setup, programming, and service information for the ValveMate 7194 auger valve controller. The ValveMate 7194 controller provides precise time, fluid pressure, and speed control for Nordson EFD 794 / 794-TC Series auger valves that use brush or brushless DC motors. Refer to the valve operating manuals for detailed information on valves.

The controller is available in a 0–2 bar (0–30 psi) version for solder pastes, silver conductive epoxies, and other filled fluids, and a 0–7 bar (0–100 psi) version for dispensing thicker filled materials, such as thermal compounds.

The controller provides an easy-to-use interface for quick setup and operation of the valve. Through the push-button interface, you can:

- Enter the dispense time setting.
- Set the motor speed for the forward and reverse motor directions.
- Enable a post-dispensing motor reverse cycle.

The controller also includes the following additional features:

- Push-button time setting or one-touch time programming.
- A floating decimal, allowing dispense time ranges of 0.001 to 99.9 seconds.
- Bright red LED display.
- Push-button purge.
- Alarms for low air-pressure, tank low level detection, and motor protection shutdown.
- End-of-cycle (EOC) feedback signal.

The ValveMate 7194 controller has been designed with the machine builder and operator in mind. The objectives are to bring valve control close to the point of application and to provide the features necessary to make setup and operation as easy and precise as possible.

The controller is easy to operate. Once you have reviewed the features, you will understand the benefits and the ease of control the ValveMate 7194 provides.

As with all EFD products, the ValveMate 7194 has been produced to exacting specifications and thoroughly tested prior to shipment.

To obtain maximum performance from this equipment, read this manual carefully.



Nordson EFD Product Safety Statement

WARNING

The safety message that follows has a WARNING level hazard.
Failure to comply could result in death or serious injury.



ELECTRIC SHOCK

Risk of electric shock. Disconnect power before removing covers and/or disconnect, lock out, and tag switches before servicing electrical equipment. If you receive even a slight electrical shock, shut down all equipment immediately. Do not restart the equipment until the problem has been identified and corrected.

CAUTION

The safety messages that follow have a CAUTION level hazard.
Failure to comply may result in minor or moderate injury.



READ MANUAL

Read manual for proper use of this equipment. Follow all safety instructions. Task- and equipment-specific warnings, cautions, and instructions are included in equipment documentation where appropriate. Make sure these instructions and all other equipment documents are accessible to persons operating or servicing equipment.



MAXIMUM AIR PRESSURE

Unless otherwise noted in the product manual, the maximum air input pressure is 7.0 bar (100 psi). Excessive air input pressure may damage the equipment. Air input pressure is intended to be applied through an external air pressure regulator rated for 0 to 7.0 bar (0 to 100 psi).



RELEASE PRESSURE

Release hydraulic and pneumatic pressure before opening, adjusting, or servicing pressurized systems or components.



BURNS

Hot surfaces! Avoid contact with the hot metal surfaces of heated components. If contact can not be avoided, wear heat-protective gloves and clothing when working around heated equipment. Failure to avoid contact with hot metal surfaces can result in personal injury.

Nordson EFD Product Safety Statement (continued)

Halogenated Hydrocarbon Solvent Hazards

Do not use halogenated hydrocarbon solvents in a pressurized system that contains aluminum components. Under pressure, these solvents can react with aluminum and explode, causing injury, death, or property damage. Halogenated hydrocarbon solvents contain one or more of the following elements.

Element	Symbol	Prefix
Fluorine	F	“Fluoro-”
Chlorine	Cl	“Chloro-”
Bromine	Br	“Bromo-”
Iodine	I	“Iodo-”

Check the Safety Data Sheet (SDS) or contact your material supplier for more information. If you must use halogenated hydrocarbon solvents, contact your EFD representative for compatible EFD components.

High Pressure Fluids

High pressure fluids, unless they are safely contained, are extremely hazardous. Always release fluid pressure before adjusting or servicing high pressure equipment. A jet of high pressure fluid can cut like a knife and cause serious bodily injury, amputation, or death. Fluids penetrating the skin can also cause toxic poisoning.

WARNING

Any injury caused by high pressure liquid can be serious. If you are injured or even suspect an injury:

- Go to an emergency room immediately.
- Tell the doctor that you suspect an injection injury.
- Show the doctor the following note.
- Tell the doctor what kind of material you were dispensing.

Medical Alert — Airless Spray Wounds: Note to Physician

Injection in the skin is a serious traumatic injury. It is important to treat the injury surgically as soon as possible. Do not delay treatment to research toxicity. Toxicity is a concern with some exotic coatings injected directly into the bloodstream.

Qualified Personnel

Equipment owners are responsible for making sure that EFD equipment is installed, operated, and serviced by qualified personnel. Qualified personnel are those employees or contractors who are trained to safely perform their assigned tasks. They are familiar with all relevant safety rules and regulations and are physically capable of performing their assigned tasks.

Nordson EFD Product Safety Statement (continued)

Intended Use

Use of EFD equipment in ways other than those described in the documentation supplied with the equipment may result in injury to persons or damage to property. Some examples of unintended use of equipment include:

- Using incompatible materials.
- Making unauthorized modifications.
- Removing or bypassing safety guards or interlocks.
- Using incompatible or damaged parts.
- Using unapproved auxiliary equipment.
- Operating equipment in excess of maximum ratings.
- Operating equipment in an explosive atmosphere.

Regulations and Approvals

Make sure all equipment is rated and approved for the environment in which it is used. Any approvals obtained for Nordson EFD equipment will be voided if instructions for installation, operation, and service are not followed. If the equipment is used in a manner not specified by Nordson EFD, the protection provided by the equipment may be impaired.

Personal Safety

To prevent injury, follow these instructions:

- Do not operate or service equipment unless you are qualified.
- Do not operate equipment unless safety guards, doors, and covers are intact and automatic interlocks are operating properly. Do not bypass or disarm any safety devices.
- Keep clear of moving equipment. Before adjusting or servicing moving equipment, shut off the power supply and wait until the equipment comes to a complete stop. Lock out power and secure the equipment to prevent unexpected movement.
- Make sure spray areas and other work areas are adequately ventilated.
- When using a syringe barrel, always keep the dispensing end of the tip pointing towards the work and away from the body or face. Store syringe barrels with the tip pointing down when they are not in use.
- Obtain and read the Safety Data Sheet (SDS) for all materials used. Follow the manufacturer's instructions for safe handling and use of materials and use recommended personal protection devices.
- Be aware of less-obvious dangers in the workplace that often cannot be completely eliminated, such as hot surfaces, sharp edges, energized electrical circuits, and moving parts that cannot be enclosed or otherwise guarded for practical reasons.
- Know where emergency stop buttons, shutoff valves, and fire extinguishers are located.
- Wear hearing protection to protect against hearing loss that can be caused by exposure to vacuum exhaust port noise over long periods of time.

Nordson EFD Product Safety Statement (continued)

Fire Safety

To prevent a fire or explosion, follow these instructions:

- Shut down all equipment immediately if you notice static sparking or arcing. Do not restart the equipment until the cause has been identified and corrected.
- Do not smoke, weld, grind, or use open flames where flammable materials are being used or stored.
- Do not heat materials to temperatures above those recommended by the manufacturer. Make sure heat monitoring and limiting devices are working properly.
- Provide adequate ventilation to prevent dangerous concentrations of volatile particles or vapors. Refer to local codes or the SDS for guidance.
- Do not disconnect live electrical circuits when working with flammable materials. Shut off power at a disconnect switch first to prevent sparking.
- Know where emergency stop buttons, shutoff valves, and fire extinguishers are located.

Preventive Maintenance

As part of maintaining continuous trouble-free use of this product, Nordson EFD recommends the following simple preventive maintenance checks:

- Periodically inspect tube-to-fitting connections for proper fit. Secure as necessary.
- Check tubing for cracks and contamination. Replace tubing as necessary.
- Check all wiring connections for looseness. Tighten as necessary.
- Clean: If a front panel requires cleaning, use a clean, soft, damp rag with a mild detergent cleaner. DO NOT USE strong solvents (MEK, acetone, THF, etc.) as they will damage the front panel material.
- Maintain: Use only a clean, dry air supply to the unit. The equipment does not require any other regular maintenance.
- Test: Verify the operation of features and the performance of equipment using the appropriate sections of this manual. Return faulty or defective units to Nordson EFD for replacement.
- Use only replacement parts that are designed for use with the original equipment. Contact your Nordson EFD representative for information and advice.

Nordson EFD Product Safety Statement (continued)

Important Disposable Component Safety Information

All Nordson EFD disposable components, including syringe barrels, cartridges, pistons, tip caps, end caps, and dispense tips, are precision engineered for one-time use. Attempting to clean and re-use components will compromise dispensing accuracy and may increase the risk of personal injury.

Always wear appropriate protective equipment and clothing suitable for your dispensing application and adhere to the following guidelines:

- Do not heat syringe barrels or cartridges to a temperature greater than 38° C (100° F).
- Dispose of components according to local regulations after one-time use.
- Do not clean components with strong solvents (MEK, acetone, THF, etc.).
- Clean cartridge retainer systems and barrel loaders with mild detergents only.
- To prevent fluid waste, use Nordson EFD SmoothFlow™ pistons.

Action in the Event of a Malfunction

If a system or any equipment in a system malfunctions, shut off the system immediately and perform the following steps:

1. Disconnect and lock out system electrical power. If using hydraulic and pneumatic shutoff valves, close and relieve pressure.
2. For Nordson EFD air-powered dispensers, remove the syringe barrel from the adapter assembly. For Nordson EFD electro-mechanical dispensers, slowly unscrew the barrel retainer and remove the barrel from the actuator.
3. Identify the reason for the malfunction and correct it before restarting the system.

Disposal

Dispose of equipment and materials used in operation and servicing according to local codes.

Specifications

NOTE: Specifications and technical details are subject to engineering change without prior notification.

Item	Specification
Cabinet size	20.0W x 6.8H x 14.2D cm (7.9W x 2.7H x 5.6D")
Weight	1.8 kg (3.9 lb)
Cycle rate	Exceeds 400 per minute
Time range	0.001–99.9 seconds
Electrical power input	30 VDC (+/- 2%),  1.33 Amp maximum
Electrical input connector	Switchcraft L722RA or equivalent, locking type
External power adapter	100–240 VAC (+/-10%), ~50/60Hz input, 30 VDC (+/-2%), 1.33 Amp output, Switchcraft S761K locking DC plug or equivalent, desktop type, AC input: IEC 320 inlet
Feedback circuits	EOC Out and Alarm Out: Electronic switch, 24 VDC, 100 mA maximum
Initiate circuits	5–24 INIT: 5–24 VDC initiate signal CC INIT and foot pedal: Dry contact initiate circuits, 19 mA, closure current INIT signal duration: No less than 0.012 seconds momentary or maintained for steady
Input air pressure	4.5–7.0 bar (65–100 psi)
Ambient operating conditions	Temperature: 5–45° C (41–113° F) Humidity: 85% RH at 30° C, 40% at 45° C non-condensing Height above sea level: 2,000 meters max (6,562 feet)
Product classification	Installation Category II Pollution Degree 2
Approvals	CE, CSA, RoHS, WEEE, China RoHS

RoHS标准相关声明 (China RoHS Hazardous Material Declaration)

产品名称 Part Name	有害物质及元素 Toxic or Hazardous Substances and Elements					
	铅 Lead (Pb)	汞 Mercury (Hg)	镉 Cadmium (Cd)	六价铬 Hexavalent Chromium (Cr6)	多溴联苯 Polybrominated Biphenyls (PBB)	多溴联苯醚 Polybrominated Diphenyl Ethers (PBDE)
外部接口 External Electrical Connectors	X	0	0	0	0	0
<p>0: 表示该产品所含有的危险成分或有害物质含量依照EIP-A, EIP-B, EIP-C的标准低于SJ/T11363-2006 限定要求。Indicates that this toxic or hazardous substance contained in all the homogeneous materials for this part, according to EIP-A, EIP-B, EIP-C is below the limit requirement in SJ/T11363-2006.</p> <p>X: 表示该产品所含有的危险成分或有害物质含量依照EIP-A, EIP-B, EIP-C的标准高于SJ/T11363-2006 限定要求。Indicates that this toxic or hazardous substance contained in all the homogeneous materials for this part, according to EIP-A, EIP-B, EIP-C is above the limit requirement in SJ/T11363-2006.</p>						

WEEE Directive



This equipment is regulated by the European Union under WEEE Directive (2012/19/EU). Refer to www.nordsonefd.com/WEEE for information about how to properly dispose of this equipment.

Operating Features

Front Panel Components

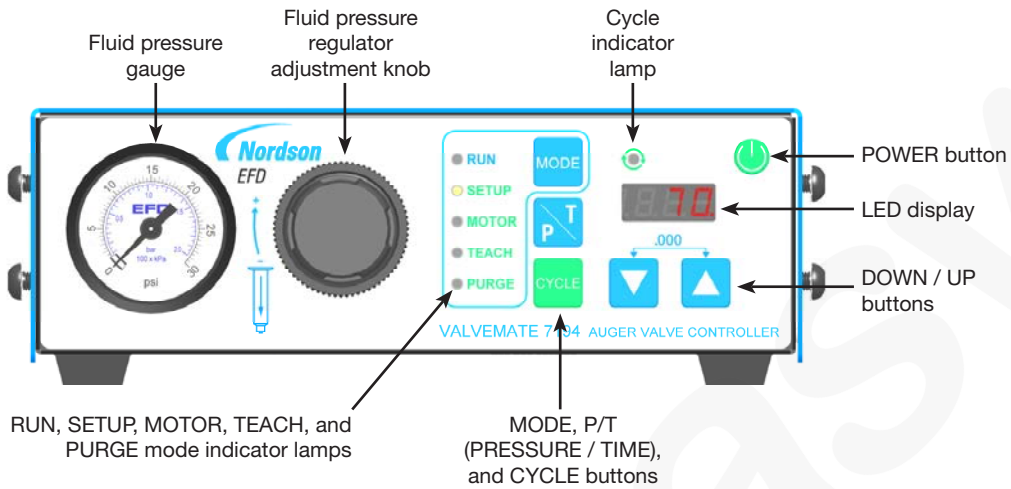

Indicator Lamps

The indicator lamp  at the upper left corner above the LED display illuminates whenever the auger valve is actuated.

The center front panel has five indicator lamps used to indicate the operational mode.

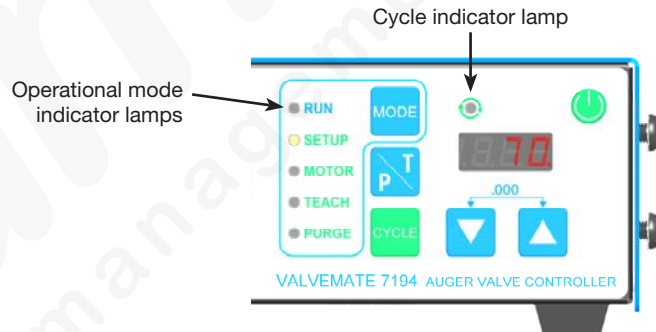

Operating Features (continued)

Back Panel Connections / Markings

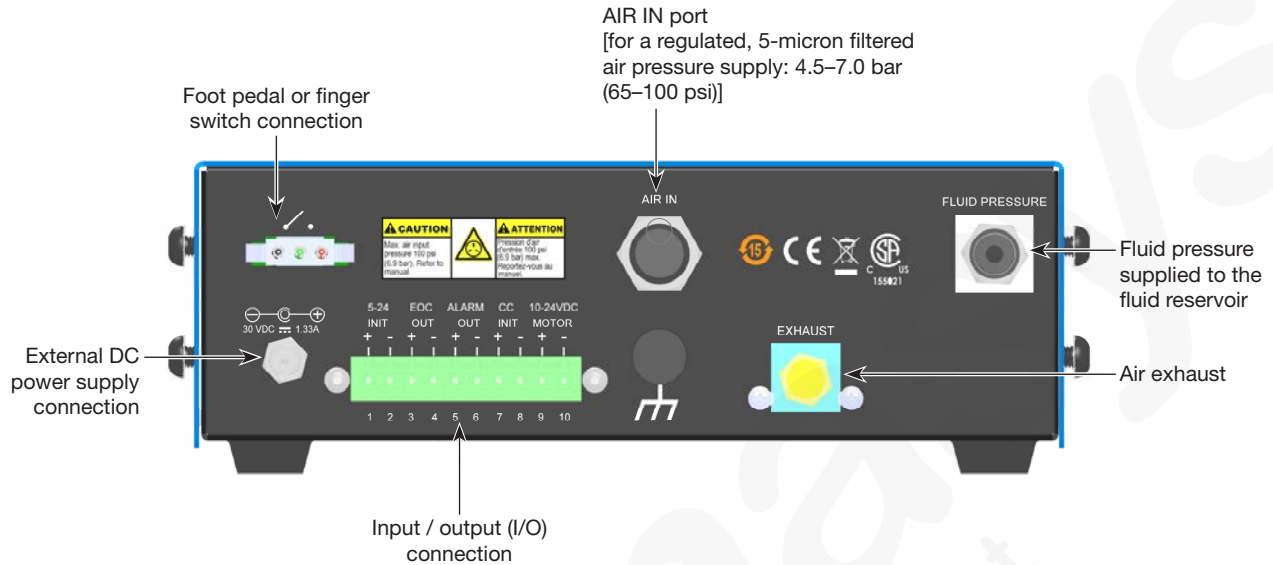

Maximum Air Pressure Caution
Caution symbol informing that the maximum air input pressure is 7.0 bar (100 psi). Excessive air input pressure may damage the equipment.



Foot Pedal/Finger Switch Connection
Switch symbol identifies the connector as a momentary contact closure switch for dispense initiates. An optional foot pedal, part #7014865, may be ordered.







Power Input Current
Input current symbol specifying that DC current is utilized on the power supply connector. The current is derived from an external 30 VDC source.



Chassis Connection
This symbol identifies the chassis connection terminal. Used for grounding the chassis to shunt leakage current and/or enhance system ESD protection.

Operating Features (continued)

Front Panel Buttons / Modes of Operation

Item	Description
POWER 	Switches power to the controller ON or OFF. NOTE: The ValveMate 7194 always powers on in the RUN mode.
RUN	Enables the external initiate inputs and disables the CYCLE button.
SETUP	Used for setup, testing, and modification of the auger dispense time for the forward and reverse directions.
MOTOR	Accesses the following setup selections: <ul style="list-style-type: none"> • Auger Speed Selection: Forward, Reverse (10 VDC to 24 VDC) • Fluid Pressure Air Output: Pulsed or Constant • Auger Valve Type: 794BR, 794BL, 790BR, or 794BL-DEC. Refer to “Valve Type Selection Table” on page 29 to make the correct selection for your valve.
TEACH	Used for easy setup and teaching of the time setting for continuous dispensing or other longer cycle applications.
PURGE	Supports purging of the auger valve. Controls operation of the auger motor, auger direction, and fluid pressure during purging.
MODE 	Cycles the controller through the operating modes: RUN, SETUP, MOTOR, TEACH, and PURGE.
P / T 	When in the RUN mode, used to momentarily toggle the LED display to show pressure; after 5 seconds, the LED display returns to the time setting.
DOWN / UP 	Decreases / increases time settings, toggles pressure units between bar and psi, or decreases / increases the voltage for the Auger Speed setting. In the SETUP and TEACH modes, pressing both DOWN / UP buttons simultaneously resets the time to zero (0). The DOWN / UP buttons are functional in the SETUP, TEACH, and RUN modes.
CYCLE 	Cycles the dispenser. Pressing CYCLE produces different results depending on the selected MODE.
ALARMS	<p>Low Air Pressure Alarm ON / OFF: Ensures sufficient pressure is present for valve operation. Can be disabled.</p> <p>CC INIT (Contact Closure Initiate): Optional usage of the CC INIT for external alarm applications. Examples of uses: low tank level switch, operator safety interlock, etc.</p> <p>Auger Motor Stuck / Frozen or Electrical Short Circuit Alarm: Conveys the status of a motor fault condition due to over-current caused by a short circuit or a jammed auger.</p> <p>NOTE: The Low Air Pressure [less than 4.1 bar (60 psi)] and CC INIT alarm conditions are assessed just before the start of a dispense operation. A motor fault alarm can occur at any time during auger valve operation.</p>
Extended User Setup Functions	<ul style="list-style-type: none"> • Low Air Pressure Alarm ON / OFF • Pressure units: bar / psi • CC INIT: Enable for Alarm IN • Steady / Timer Override mode

Installation

Prior to installing the valve, read the associated reservoir and valve operating manuals to become familiar with the operation of all components of the dispensing system.

Typical Setup: ValveMate 7194 System with a 794 Valve

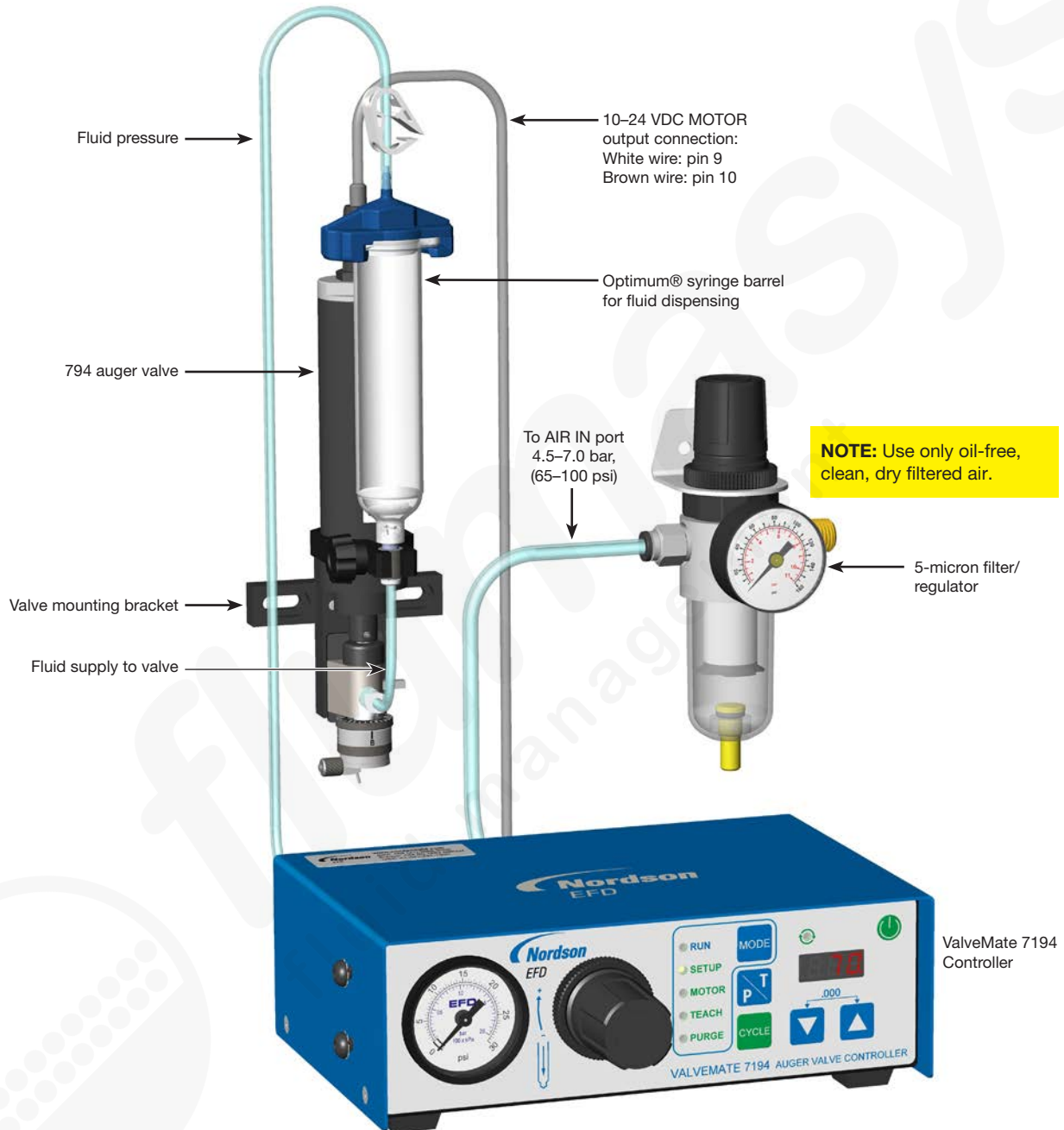

⚠ CAUTION

Always depressurize a reservoir before opening it. For tank installations: (1) slide the shutoff valve on the air line away from the reservoir and (2) open the pressure relief valve. Before opening the reservoir, check the pressure gauge to verify that pressure is zero (0). For syringe barrel installations, disconnect the adapter assembly from the reservoir pressure regulator and gauge. On all EFD syringe barrels, the unique threaded design provides fail-safe air pressure release during cap removal.

Installation (continued)

Prior to installing the valve, read the associated reservoir and valve operating manuals to become familiar with the operation of all components of the dispensing system.

Typical Setup: ValveMate 7194 System with a 794-TC Valve

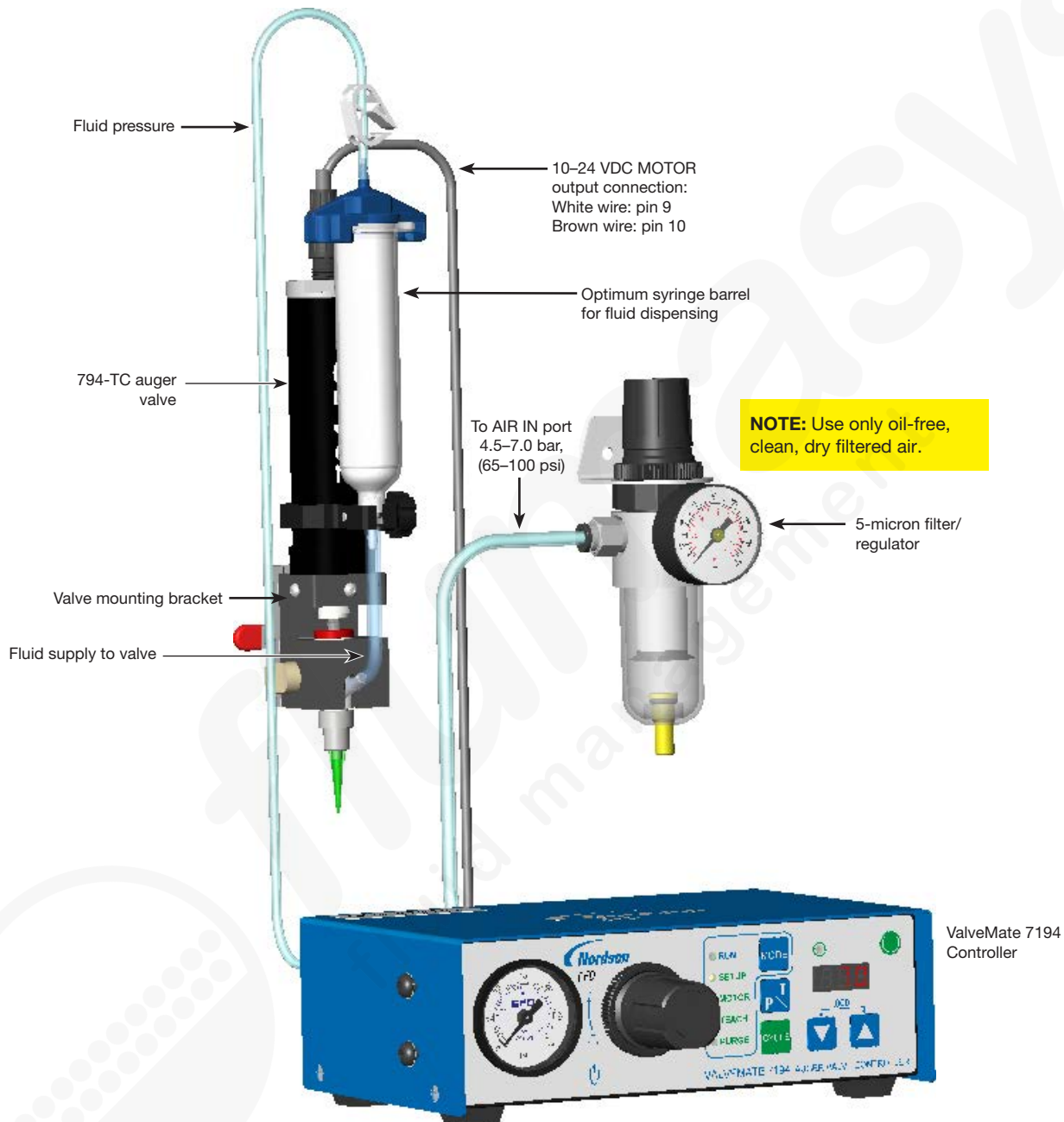

⚠ CAUTION

Always depressurize a reservoir before opening it. For tank installations: (1) slide the shutoff valve on the air line away from the reservoir and (2) open the pressure relief valve. Before opening the reservoir, check the pressure gauge to verify that pressure is zero (0). For syringe barrel installations, disconnect the adapter assembly from the reservoir pressure regulator and gauge. On all EFD syringe barrels, the unique threaded design provides fail-safe air pressure release during cap removal.

Mounting the ValveMate 7194 Controller

Use the universal mounting bracket (included) to mount the controller either over or under the cabinet. The bracket allows the controller to pivot 30 degrees from a horizontal position. When mounted under a workbench, secure with screws or nuts and bolts to support 6 kg (14 lb).



Optional Panel Mount Kit

For panel mounting, an optional panel mount bracket kit is available. (Order P/N 7026544)

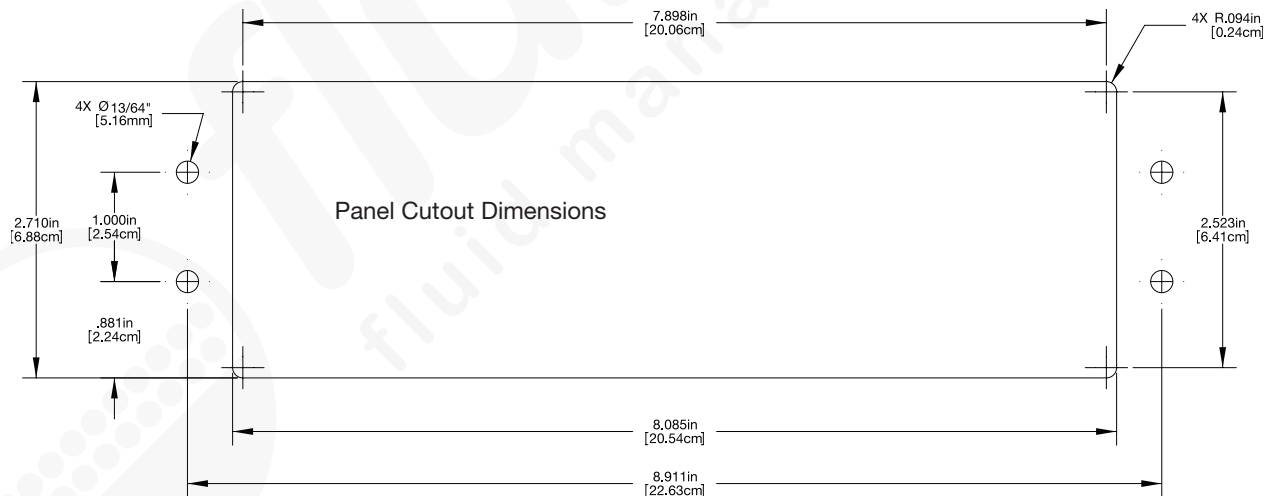

Connecting the External Power Adapter

A universal 30 VDC remote power supply is included with each ValveMate 7194. Select a convenient location and connect to the appropriate input voltage.



Connecting the Valve Initiate Signal

Connect a valve initiate signal to the controller. The valve can be initiated by any of the following three inputs:

- 5-24 INIT: Application of 5–24 VDC to the 5-24 INIT terminals, pins 1 and 2.
- CC INIT: Application of mechanical contacts on CC INIT terminals, pins 7 and 8.
- Foot pedal: Use of the optional EFD foot pedal (P/N 7014865) plugged into foot pedal receptacle.

A connection schematic is provided. Refer to “I/O Connection Schematics” on page 20.

Connecting Inputs / Outputs

The 10 pin terminal strip includes 5–24 VDC and contact closure (CC) initiate inputs. Outputs include an Alarm Out, end-of-cycle (EOC) feedback, and a 10–24 VDC motor voltage output for energizing the auger valve.

- 5–24 INIT: Dispense initiate input activated with a 5–24 VDC input voltage.
- EOC OUT: End-of-cycle feedback.
- ALARM OUT: Circuit that closes when an alarm condition is present.
- CC INIT: Dispense initiate input activated with a contact closure switch.
- 10–24 VDC MOTOR: Auger motor connection. The auger valve motor lead wires connect to pins 9 and 10 of the 10-pin terminal strip. The white wire connects to the (+) terminal on pin 9 and the brown wire connects to the (-) terminal on pin 10.

NOTE: ALARM OUT and EOC (end-of-cycle) only function in RUN mode.

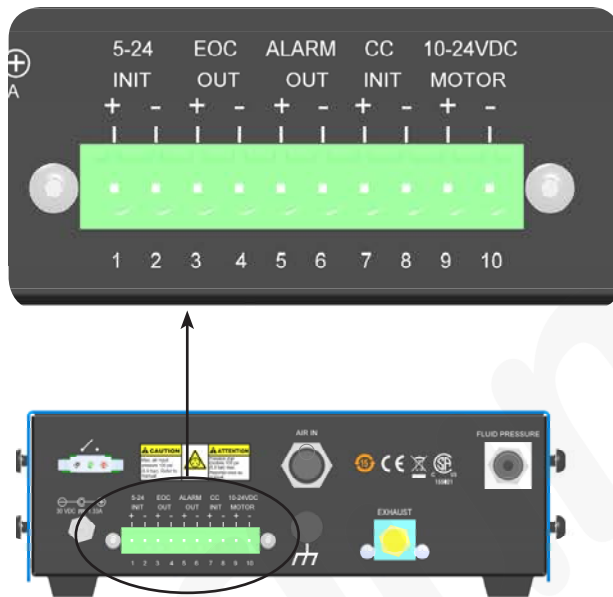

Connecting Inputs / Outputs (continued)

5–24 INIT Connection

The controller can be initiated through application of 5–24 VDC to the 5-24 INIT terminals, pins 1 and 2. The controller can also be initiated by the application of mechanical contacts on CC INIT terminals, pins 7 and 8. Refer to “Connecting the Valve Initiate Signal” on page 17.

Alarm OUT Connection

The controller features an alarm output circuit. The Alarm OUT circuit closes when an alarm condition is present. The Alarm OUT circuit is a normally open electronic switch that can switch an external 5–24 VDC circuit to an external signaling device or PLC input. Maximum load is 100 mA, 5–24 VDC.

End-of-Cycle (EOC) OUT Connection

The controller features an EOC circuit to acknowledge an active valve actuation cycle. The EOC circuit is a normally closed electronic switch that can switch an external 5–24 VDC circuit to an external signaling device or PLC input. Maximum load is 100 mA, 5–24 VDC.

EOC signaling functions when the controller is in the RUN mode. The EOC output is closed when in the controller is in the RUN mode without valve actuation. The EOC switch opens upon valve actuation and closes when the valve actuation cycle completes. A valve actuation cycle consists of a forward direction auger actuation plus an enabled reverse direction auger actuation.

CC INIT Connection

The controller can also be initiated by the application of mechanical contacts on CC INIT terminals, pins 7 and 8. Refer to “Connecting the Valve Initiate Signal” on page 17.

The controller offers an alternate use of the CC INIT initiate input for an external alarm signal. Refer to the “How to Enable / Disable CC INIT I/O as an External Alarm Input” on page 28 to enable. When enabled as an alarm input, the CC INIT on pins 7 and 8 is connected to a normally closed switch, such as a low level reservoir float switch. When the CC INIT is enabled as an alarm input, the connections on pins 7 and 8 must be closed to initiate a valve actuation cycle.

10–24 VDC MOTOR

The 10–24 VDC MOTOR output powers the auger valve during a dispense cycle. Both the (+) and (-) 10–24 VDC MOTOR output pins are isolated from common or ground circuits and should only be connected to a Nordson EFD auger valve. The 10–24 VDC MOTOR output polarity is per the (+) and (-) labels when the auger actuates in the forward direction. The output polarity is reversed when the auger actuates in the reverse direction.

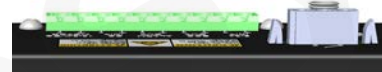
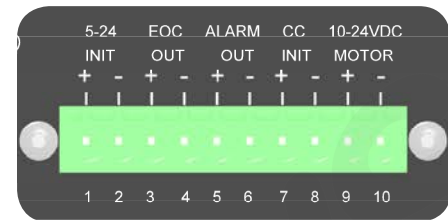

I/O Connection Schematics

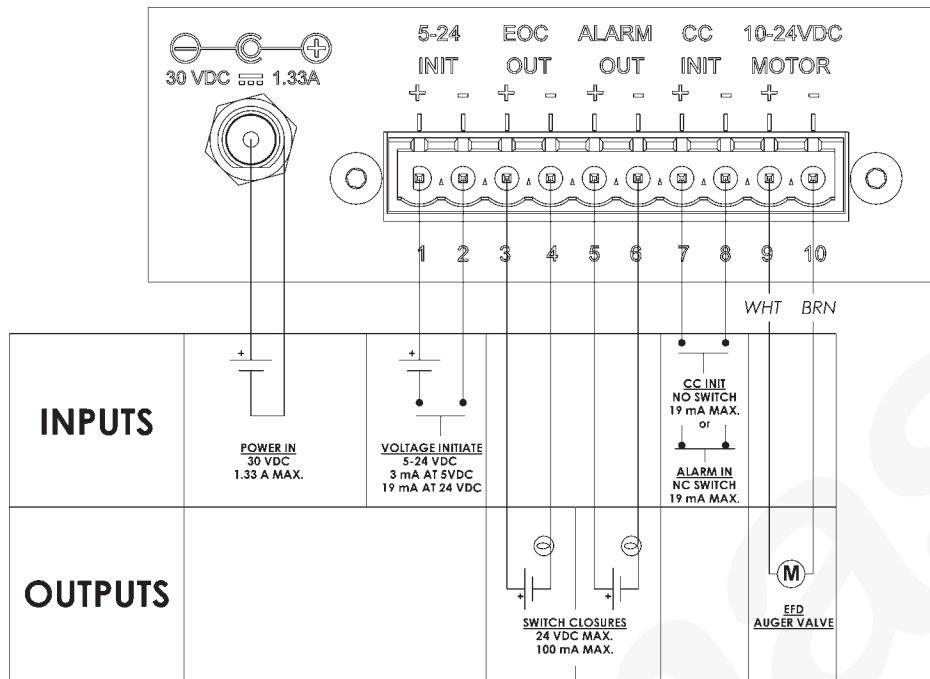

I/O external wiring diagram

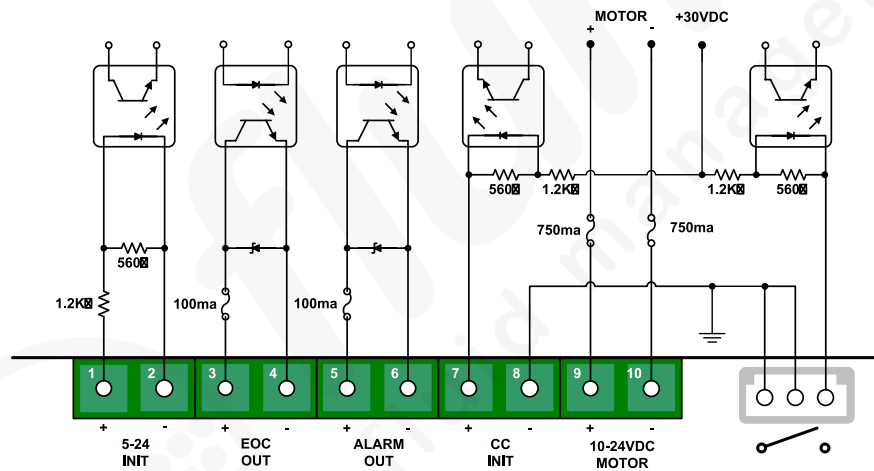

I/O electrical schematic

Connecting Air

Air Input Connection

Connect the controller to the plant air source through the supplied 5-micron filter/regulator assembly (P/N 7016547). Use the supplied 6 mm tubing to connect the air between the AIR IN push-in fitting and the constant air output push-in fitting on the 5-micron filter/regulator assembly. Refer to “Typical Setup: ValveMate 7194 System with a 794 Valve” on page 14 or to “Typical Setup: ValveMate 7194 System with a 794-TC Valve” on page 15, as applicable.

Air Output Connection

Use the supplied 4 mm air tubing to connect the air between the FLUID PRESSURE push-in fitting and the fluid reservoir.

NOTE: When the Air Output mode is set to Constant, the air output turns ON at the first dispense cycle. It will remain ON if a new dispense initiate occurs within 16 seconds after completion of a dispense cycle. The air output turns OFF as follows: (1) if 16 seconds elapse during which there is no dispense initiate, or (2) after a MODE change. When the Air Output mode is set to Pulsed, the air output cycles ON and OFF depending on whether the valve signal is active. Nordson EFD recommends operating in the Constant mode.

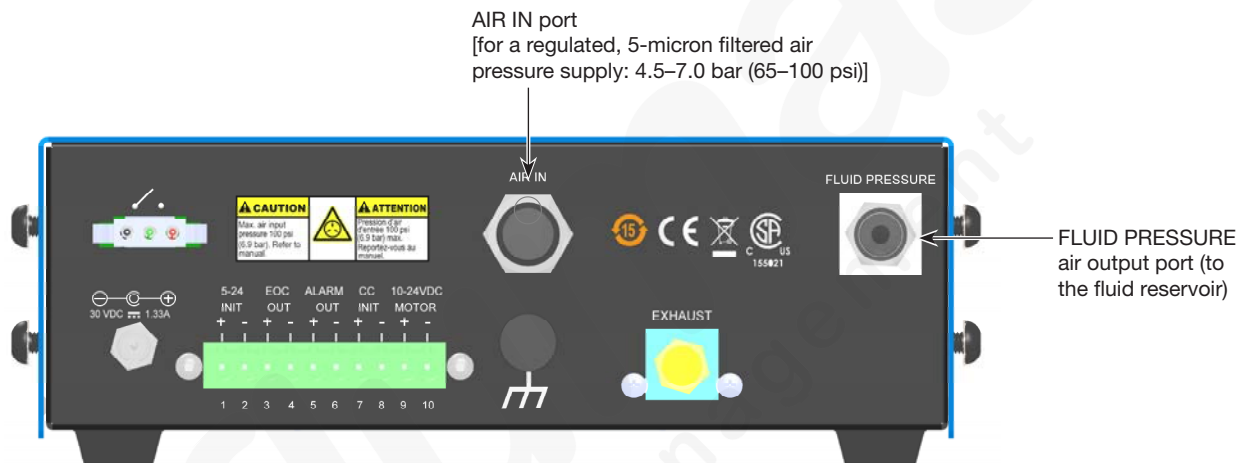

IMPORTANT

The air output push-in fitting has an internal safety stop valve. Ensure that the valve air hose is fully inserted into the fitting to allow proper air flow. The air hose insert depth is 15 mm (0.6") when it is completely inserted into the air output push-in fitting, thus ensuring unrestricted air flow.

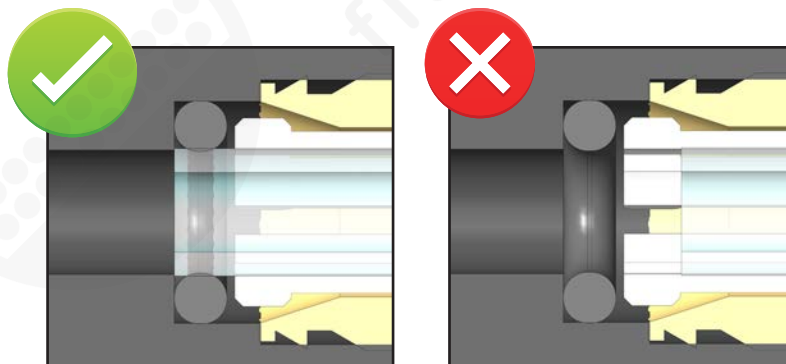

Installing a 794 Auger Valve

Prior to installing the valve, read the associated reservoir and valve operating manuals to become familiar with the operation of all components of the dispensing system.

WARNING

Disconnect the electrical power and inlet air pressure to the factory automation system and valve controller prior to proceeding.

1. Mount the valve securely to the Z axis of the robot using the bracket provided for the valve or another appropriate mounting bracket for other machines.
2. Connect the motor lead wires to the valve controller:
 - White wire: pin 9 (+)
 - Brown wire: pin 10 (-)
3. Attach the syringe barrel outlet fitting to the end of a syringe barrel of material to be dispensed.
4. Insert the syringe barrel into the barrel clamp position as required and clamp securely.
5. Snap the auger assembly into the sliding head after first aligning the inlet fitting toward the front of the valve.
6. Trim a length of the supply hose provided to approximately 80 mm (3 1/8") and push into the barrel outlet and auger assembly input fittings.
7. Do the following to connect the fluid pressure to the valve:
 - a. Cut off the plastic bayonet quick-connect fitting from the end of the syringe barrel adapter assembly.
 - b. Attach the blue end of the syringe barrel adapter assembly to the top of the barrel.
 - c. Push the end of the hose into the FLUID PRESSURE air output fitting.
8. Install an EFD 1/4" long dispensing tip of the appropriate gauge.

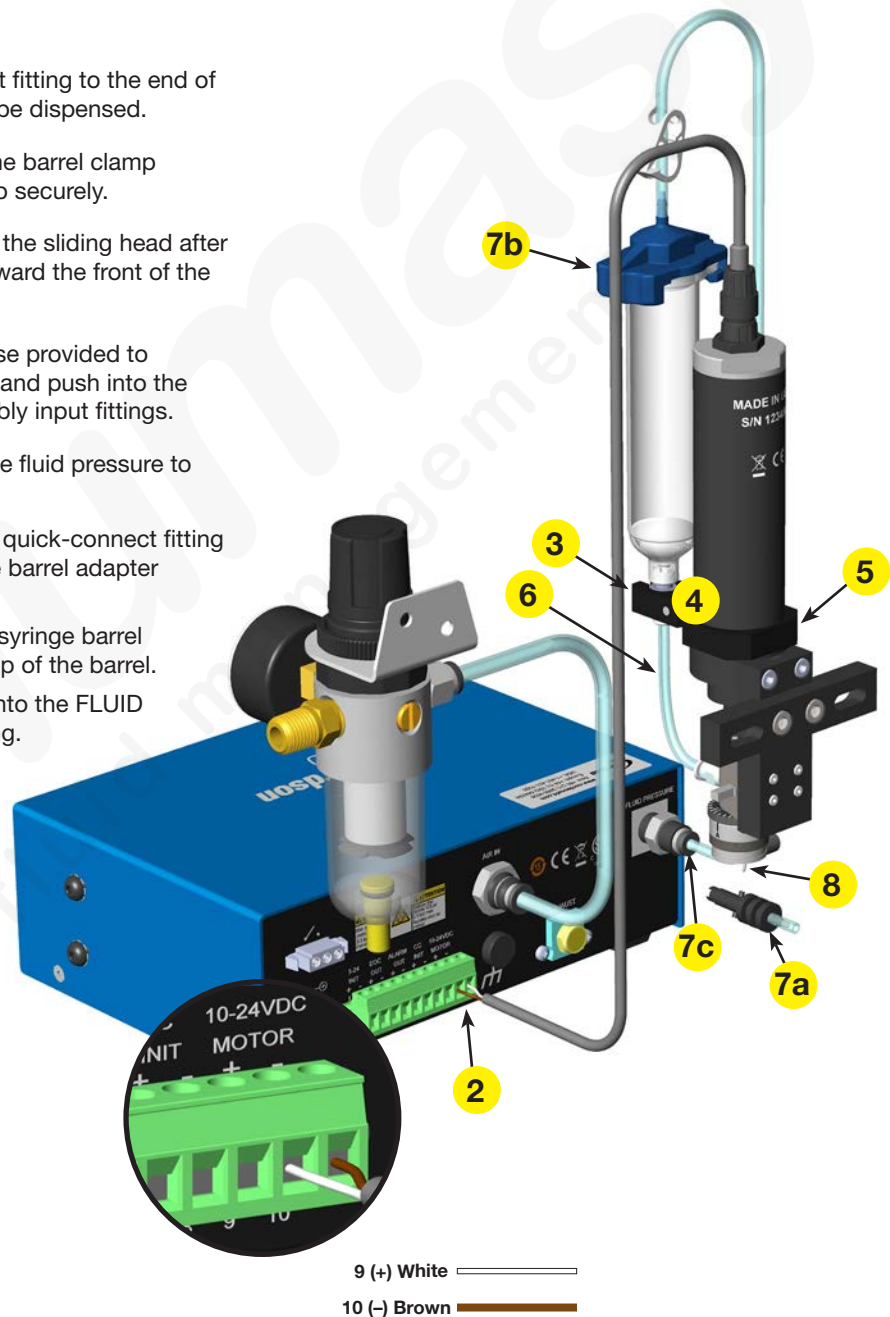

Installing a 794-TC Auger Valve

Prior to installing the valve, read the associated reservoir and valve operating manuals to become familiar with the operation of all components of the dispensing system.

WARNING

Disconnect the electrical power and inlet air pressure to the factory automation system and valve controller prior to proceeding.

1. Mount the valve securely to the Z axis of the robot using the bracket provided for the valve or another appropriate mounting bracket for other machines.
2. Connect the motor lead wires to the valve controller:
 - White wire: pin 9 (+)
 - Brown wire: pin 10 (-)
3. Attach the barrel outlet fitting to the end of a barrel of material to be dispensed.
4. Insert the barrel into the barrel clamp, position as required, and clamp securely.
5. Use the supplied 4 mm push-in fitting and 3/32" x 5/32" material supply tubing to connect the material supply to the fluid inlet on the auger valve.
6. Attach the blue end of the barrel adapter assembly to the end of the barrel.
7. Connect the bayonet fitting to the valve controller air output.
8. Securely install a tip onto the luer fitting.

NOTE: Tip selection is critical to achieve optimum valve performance. In general, use the shortest and least restrictive tip possible to provide the best paste flow. 794-TC valves are packaged with a dispensing tip kit for maximum fluid control.

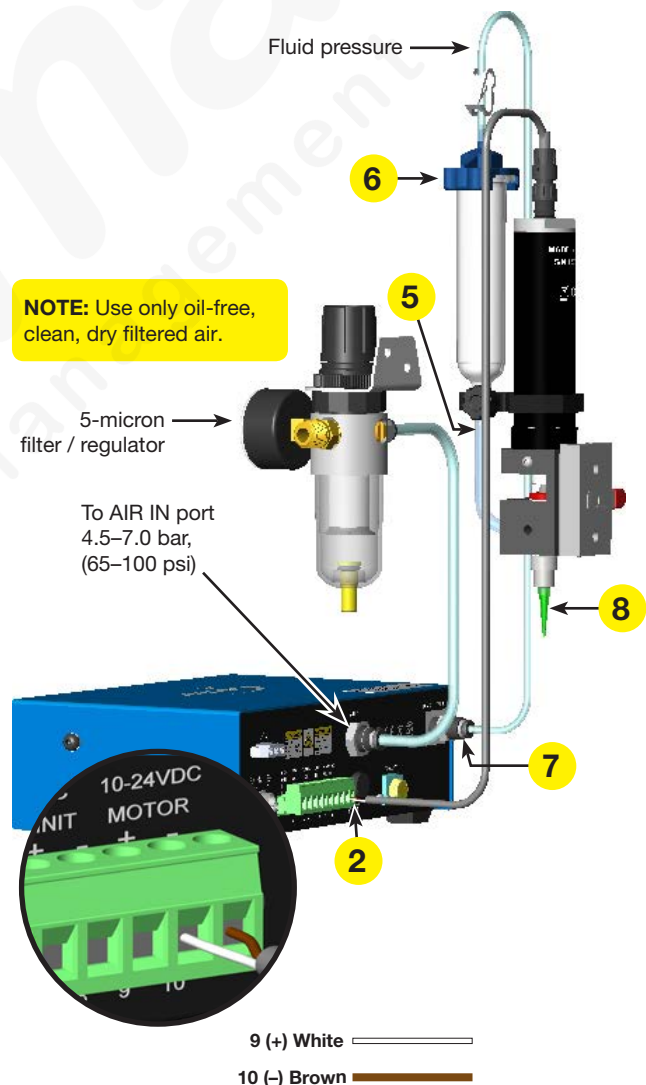

System Setup Recommendations

Reservoir Pressure Setting

Air pressure is used to maintain a constant flow of fluid from the reservoir to the auger. In general, 0.5–0.8 bar (8–12 psi) is enough pressure for solder paste. Some experimentation may be necessary to find the correct pressure for other fluids.

Set the pressure so there is enough to keep the auger primed at all times, but not so much pressure that the fluid is forced past the auger when the valve is off.

Begin by setting the pressure at 0.68 bar (10 psi). Operate the valve in STEADY mode (without a dispensing tip installed) until material flows from the outlet. If after 10 seconds material does not flow, increase pressure. The pressure setting is correct when fluid does not flow between cycles when the valve is off.

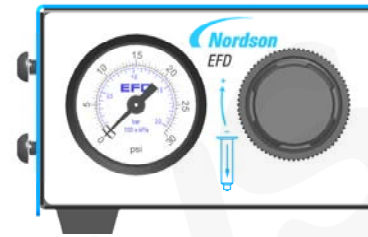

Controlling Deposit Size

There are three ways to control the output from the valve: dispense time, dispensing tip diameter, and motor speed.

- Dispense time is the primary control of deposit size. For optimal results, the minimum time setting should be greater than 0.070 seconds.
- The diameter of the dispensing tip also affects deposit size. A smaller diameter tip reduces deposit size by restricting the fluid flow. Nordson EFD recommends using as large a tip as practical for the application. This will keep the time setting low, thus maximizing productivity.
- The motor speed control provides fine-tuning of the output. The reference for motor speed on the LED display is in voltage. Normal operating voltage is 24 VDC, which is the maximum speed; the speed can be reduced to 10 VDC (the minimum speed). Reducing motor speed reduces the dispensing rate. This is useful when dispensing stripes or beads of material. The dispensing rate can be coordinated with the linear travel speed of the valve, as in the case of XY motion control.

Auger Forward / Reverse Direction

The 7194 controller features the option to reverse the rotational direction of the motor. Forward motor rotation is used to dispense material. Reverse motor rotation creates a snuff-back action, similar to the vacuum in a syringe barrel. The forward direction is a clockwise rotation of the auger as viewed from above on the the 790BR, 794BR, 794BL, 794BL-DEC, and 794-TC valves. The reverse motor direction creates a cleaner deposit at the end of a dispense cycle, particularly with materials that are more tacky or sticky.

Power Off

The power button controls both the power and the air supply for the controller. Nordson EFD recommends switching power OFF whenever the system will not be used for an extended period of time.

Testing the Installation

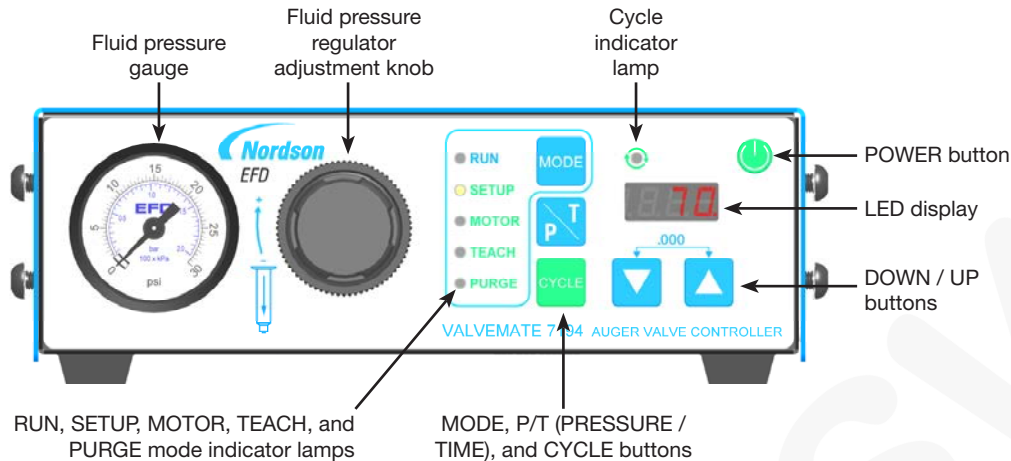

Verify the Pressure Settings

1. Press POWER to switch power ON.
2. Press MODE until the RUN lamp illuminates.
3. Press P/T to momentarily display the input air pressure on the LED display. Adjust the external 5-micron filter/regulator to 4.5 bar (65 psi).
4. Turn the fluid pressure regulator adjustment knob to set the fluid pressure to 0.68 bar (10 psi), as displayed on the fluid pressure gage.

Purge the System





1. Place the dot-pattern card (supplied) with the purge compound under the dispensing tip.
2. Press MODE until the PURGE lamp illuminates. PuF is visible.
3. Press DOWN to change to Pur .
4. Press DOWN / UP to select the Fluid Pressure Air Output mode: OFF , Pulsed , or Constant .
5. Press and hold CYCLE . The motor starts.
6. Continue pressing CYCLE until the red purge compound begins to dispense from the tip. Continue dispensing until the valve is purged of all air.

Test the System





1. Press MODE until the MOTOR lamp illuminates. The current Forward speed setting is visible.
2. Press UP to advance the Forward speed to F24 .
3. Press PRESSURE / TIME two times, then press DOWN / UP to select Constant air output.
4. Press MODE until the TEACH lamp illuminates. If the displayed time value is non-zero, simultaneously press DOWN / UP to clear the value.
5. Press and hold CYCLE OR depress the foot pedal while observing the deposit size. Initially, the LED display blinks to signify the beginning of a dispense actuation. As dispensing begins, the display shows the accumulated total dispense time.
6. Release CYCLE or the foot pedal. Subsequent actuations are added to the total dispense time. This time value is saved as the current forward dispense time. Clear the time to zero to repeat the process until the desired deposit size is achieved.
7. Press MODE until the SETUP lamp illuminates. Press CYCLE or depress the foot pedal to initiate the programmed deposit. Each initiate repeats the programmed deposit. A deposit cycle is canceled if an initiate input occurs during a dispense cycle.
8. Press DOWN / UP to make minor adjustments to the dispense time. Press and hold DOWN / UP for rapid time adjustments.
9. Press MODE until the MOTOR lamp illuminates. Press DOWN to decrease the motor voltage to F16.
10. Press CYCLE or depress the foot pedal and note the deposit size change. Repeat step 9 to decrease the motor voltage to F10, then restore the voltage to F24.

How To





How to Set the Forward Dispense Time

- Step 1 Press MODE  until the SETUP lamp illuminates.
- Step 2 Press DOWN / UP   to select a time value from **.000** to **99.9**.
- Step 3 Press MODE  to advance.





How to Make On-the-Fly (OTF) Time Adjustments in the RUN Mode

- Step 1 Press CYCLE  to enable OTF. The LED display blinks.
- Step 2 Press DOWN / UP   to adjust the valve ON time.
- Step 3 Press CYCLE  to disable OTF. The LED display stops blinking.





How to Set the Forward Motor Speed

- Step 1 Press MODE  until the MOTOR lamp illuminates. The current Forward speed setting is visible: **F 14** (where F = Forward, and digits 2 and 3 = a voltage between 10 and 24; for example, F14 = a forward speed of 14V).
- Step 2 Press DOWN / UP   to select a value from F10 to F24 (10V being the slowest speed and 24V being the fastest speed).
- Step 3 Press MODE  to advance.

How to Set the Reverse Motor Speed









- Step 1 Press MODE  until the MOTOR lamp illuminates.
- Step 2 Press PRESSURE / TIME  once. The current Reverse speed setting is visible: **r 12** (where r = Reverse, and digits 2 and 3 = a voltage between 10 and 24; for example, r12 = a reverse speed of 12V).
- Step 3 Press DOWN / UP   to select a value from r10 to r24 (10V being the slowest speed and 24V being the fastest speed).
- Step 4 Press MODE  to advance.

How to Set the Fluid Pressure Air Output Mode







- Step 1 Press MODE  until the MOTOR lamp illuminates.
- Step 2 Press PRESSURE / TIME  two times.
- Step 3 Press DOWN / UP   to select Pulsed **Pul** or Constant **Con**.
- Step 4 Press MODE  to advance.

How To (continued)







How to Set the Auger Valve Type

- Step 1 Press MODE  until the MOTOR lamp illuminates.
- Step 2 Press PRESSURE / TIME  three times.
- Step 3 Press DOWN / UP   to select 794BR , 794BL , 790BR , or 794BL-DEC . Refer to “Valve Type Selection Table” on page 29 to make the correct selection for your valve.
- Step 4 Press MODE  to advance.

How to Enable / Disable Reverse Motor Rotation

- Step 1 Press MODE  until the SETUP lamp illuminates.
- Step 2 Press and hold PRESSURE / TIME  until the current time setting blinks rapidly.
Value = zero (0): Disabled
Value = 0.001–0.999: Enabled
- Step 3 Release PRESSURE / TIME  to adjust the time setting. The LED display continues blinking rapidly.
- Step 4 Press DOWN / UP   to set the desired non-zero time value.
NOTE: A non-zero value enables reverse auger rotation at the selected time setting.
- Step 5 Press MODE  to advance.

How to Use the TEACH Mode

- Step 1 Press MODE  until the TEACH lamp illuminates.
- Step 2 Press and hold CYCLE  or depress the foot pedal in the TEACH mode. The LED display blinks before the TEACH function begins.
- Step 3 Add incremental time by a continued press and hold of CYCLE , or depress and hold the foot pedal.
- Step 4 To fine-tune the programmed pulse time, press DOWN / UP   to decrease / increase time.
- Step 5 Press DOWN / UP   simultaneously to reset the LED display to 0.000 and to restart the TEACH process.

How to Purge with or without Fluid Pressure

Press MODE  until the PURGE lamp illuminates. PuF (Forward)  is visible.

To PURGE without fluid pressure:

- Step 1 Press CYCLE  or depress the foot pedal to purge.

To PURGE with fluid pressure:







- Step 1 Press UP  to toggle the Fluid Pressure Air Output mode to PuL (Pulsed)  or Con (Constant) .

NOTE: Upon entry, the Fluid Pressure Air Output mode is OFF .









- Step 2 Press CYCLE  or depress the foot pedal to purge.

How To (continued)











How to Enable / Disable the Steady / Timer Override Mode

- Step 1 Press MODE  until the SETUP lamp illuminates.
- Step 2 Press PRESSURE / TIME  and hold for 3 seconds. The Reverse dispense time setting blinks rapidly to distinguish it from the Forward dispense time setting.
- Step 3 Press and release PRESSURE / TIME  to show the Forward dispense time setting, which blinks at a low speed.
- Step 4 Press DOWN / UP   to toggle between Steady  or Timer Override  mode.













How to Enable / Disable the Low Air Pressure Alarm

- Step 1 Press MODE  until the MOTOR lamp illuminates.
- Step 2 Press and hold PRESSURE / TIME  until  or  is visible.
- Step 3 Press DOWN / UP   to toggle between Alarm ON  or Alarm OFF .
- Step 4 Press MODE  to advance.

How to Select PSI or BAR Pressure Readout

- Step 1 Press MODE  until the MOTOR lamp illuminates.
- Step 2 Press and hold PRESSURE / TIME  until  or  is visible.
- Step 3 Press PRESSURE / TIME  one time.
- Step 4 Press DOWN / UP   to toggle between  for BAR and  for PSI:
PSI format: 0.0 to 101.0
BAR format: 0.0 to 7.0
- Step 5 Press MODE  to advance.

How to Enable / Disable CC INIT I/O as an External Alarm Input

- Step 1 Press MODE  until the MOTOR lamp illuminates.
 - Step 2 Press and hold PRESSURE / TIME  until  or  is visible.
 - Step 3 Press PRESSURE / TIME  two times.
 - Step 4 Press DOWN / UP   to toggle between  or .
- CC INIT function is:
 CCI:  Contact closure initiate input
 ALI:  External alarm input
- Step 5 Press MODE  to advance.

Valve Type Selection Table

Use the following table to select the correct auger valve type. Refer to “How to Set the Auger Valve Type” on page 27 for the valve type selection procedure.

Brush Motor Valves	Valve Part #	Auger Valve Type Selection under the Motor Menu
794-SB	7029743	794BL-DEC 4dE
794-FB	7029742	
794-SB	7029744	
794-FB	7029463	
790-BR	7021907	790BR 0br
790-BR	7021854	
790-BR	7021855	

Brushless Motor Valves	Valve Part #	Auger Valve Type Selection under the Motor Menu
794-SR	7021916	794BR 4br
794-FR	7029745	
794-SR	7021917	
794-FR	7029746	
794-TC	7363510	
794-TC	7363511	
794-TC	7363512	

Motor / Electrical Short Circuit Alarm

The ValveMate 7194 controller detects significant motor overload conditions or electrical short circuits of the I/O outputs (pins 9 and 10) for the auger motor power. This alarm is always enabled to detect these conditions. This alarm can also occur if the wrong auger valve type is selected.

When a motor / electrical short circuit alarm occurs:

- The MODE lamp blinks and the LED displays alternately blinks **noE** and **---**.
- Motor power switches OFF

Refer to “Troubleshooting” on page 31 to troubleshoot this alarm.

Part Numbers

Part #	Description
7360201	ValveMate 7194 Controller, 0-2 bar (0-30 psi)
7362374	ValveMate 7194 Controller, 0-7 bar (0-100 psi)

Replacement Parts

Item	Part #	Description
1	7026518	4 mm bulkhead fitting
2	7026520	Solenoid valve, 24 VDC, 1.8 W, with connector
3	7026524	M4 x 20 mm thumbscrew assembly
4	7026521	10-position terminal block connector with I/O, 5.08 mm
5	7016567	Gauge, 0-2 bar (0-30 psi)
	7014866	Gauge, 0-7 bar (0-100 psi)
6	7026523	Regulator, 2 bar (30 psi)
	7026525	Regulator, 7 bar (100 psi)
Not shown	7360759	Universal desktop power supply, 30 VDC, 40 W
Not shown	7026543	2 m (6.6 ft) DC cable assembly with locking connector
Not shown	7026522	Pivot bracket
Not shown	7026544	Panel mount bracket
Not shown	7016547	5-micron filter/regulator assembly
Not shown	7014865	Optional foot pedal

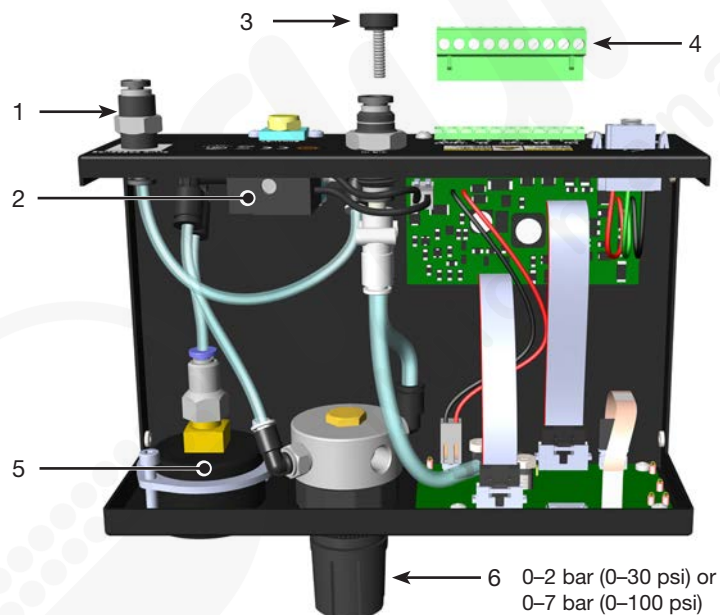

Troubleshooting

Problem	Possible Cause	Corrective Action
LED display toggles between ALr and pressure value and will not accept initiate signal	Air pressure to the controller dropped below 4.1 bar (60 psi)	Increase the air input pressure to 4.8 bar (70 psi). Press MODE  to reset. If the problem persists, ensure that devices such as air cylinders are not causing a pressure drop in the controller air input line.
Controller not responding to the initiate signal	Controller not in RUN mode	Ensure that the controller is in the RUN mode.
	Time setting too low	A response delay in the pneumatic circuit prevents the valve from opening when the time setting is set at or below 0.010 seconds. Increase the time setting. The signal must break cleanly before the next signal is initiated.
Timer inoperative	Controller in Steady / Timer Override mode	Disable the Steady / Timer Override mode. Refer to “How to Enable / Disable the Steady / Timer Override Mode” on page 28.
LED display blinking ALr – OPn	External alarm enabled and circuit open	Check for the cause of the fault or disable the external alarm. Refer to “How to Enable / Disable CC INIT I/O as an External Alarm Input” on page 28.
MODE lamp blinking and LED display blinking ALr – OPn	Auger motor stuck / frozen, electrical short circuit, or incorrect valve type selected	Ensure that the auger motor is not stuck / frozen. Verify that the wiring to pins 9 and 10 is not shorted. Ensure that the correct valve type is selected. Refer to “How to Set the Auger Valve Type” on page 27 to select the valve type.

NORDSON EFD ONE YEAR LIMITED WARRANTY

Nordson EFD products are warranted for one year from date of purchase to be free from defects in material and workmanship (but not against damage caused by misuse, abrasion, corrosion, negligence, accident, faulty installation or by dispensing material incompatible with equipment) when the equipment is installed and operated in accordance with factory recommendations and instructions. Nordson EFD will repair or replace free of charge any part of the equipment thus found to be defective, on authorized return of the part prepaid to our factory during the warranty period. In no event shall any liability or obligation of Nordson EFD arising from this warranty exceed the purchase price of the equipment. This warranty is valid only when oil-free, clean, dry, filtered air is used.

Nordson EFD makes no warranty of merchantability or fitness for a particular purpose. In no event shall Nordson EFD be liable for incidental or consequential damages.

