

E Series Automated Dispensing Systems

Operating Manual

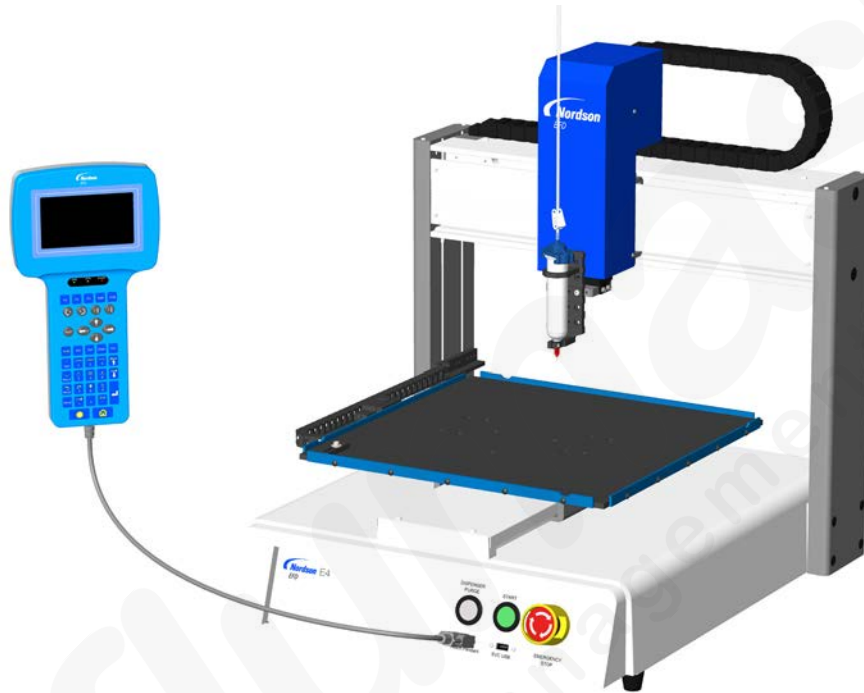

Electronic pdf files of Nordson EFD manuals are also available at www.nordsonefd.com

Nordson
EFD

You have selected a reliable, high-quality dispensing system from Nordson EFD, the world leader in fluid dispensing. Nordson EFD automated dispensing systems are designed specifically for industrial dispensing and will provide you with years of trouble-free, productive service.

This manual will help you maximize the usefulness of your automated dispensing system.

Please spend a few minutes to become familiar with the controls and features. Follow our recommended testing procedures. Review the helpful information we have included, which is based on more than 50 years of industrial dispensing experience.

Most questions you will have are answered in this manual. However, if you need assistance, please do not hesitate to contact EFD or your authorized EFD distributor. Detailed contact information is provided on the last page of this document.

The Nordson EFD Pledge

Thank You!

You have just purchased the world's finest precision dispensing equipment.

I want you to know that all of us at Nordson EFD value your business and will do everything in our power to make you a satisfied customer.

If at any time you are not fully satisfied with our equipment or the support provided by your Nordson EFD Product Application Specialist, please contact me personally at 800.556.3484 (US), 401.431.7000 (outside US), or Srini.Subramanian@nordsonefd.com.

I guarantee that we will resolve any problems to your satisfaction.

Thanks again for choosing Nordson EFD.

Srini Subramanian
Srini Subramanian, General Manager



Contents

Contents	3
Introduction	6
Nordson EFD Product Safety Statement	7
Halogenated Hydrocarbon Solvent Hazards	8
High Pressure Fluids	8
Qualified Personnel	8
Intended Use	8
Regulations and Approvals	9
Personal Safety	9
Fire Safety	9
Preventive Maintenance	10
Important Disposable Component Safety Information	10
Action in the Event of a Malfunction	10
Disposal	10
Equipment-Specific Safety Information	11
Specifications	12
Operating Features	15
Component Identification	15
Front Panel	15
Back Panel	16
Installation	16
Unpack the System Components	16
Position the Robot and Install and Connect Components	17
Prepare the Work Surface or Fixture Plate	18
Connect Inputs / Outputs (Optional)	18
Connect a Barcode Scanner (Optional)	18
Power On the System	19
Concepts	20
About Programs and Commands	20
About Tip Height	21
About Mark Points	21
Overview of the Teach Pendant	22
Run Mode vs. Teach Mode	23
Executing Functions and Entering Numeric Data	23
Navigating the Menus	24
Jogging the Dispensing Tip	24
Teach Pendant Key Descriptions	25
Teach Pendant Menu Structure	26
Teach Pendant Menu Item Descriptions	27
Program Menu	27
Menu 1	28
Utility Menu	29
Diagnostic Menu	30
Menu 2	30
Setup Menu	31
Type Menu	33
USB Menu	33

Continued on next page

Contents (continued)

Setup	34
Switching from Run Mode to Teach Mode.....	34
Setting System Parameters	34
XY Move Speed or Z Move Speed.....	35
Axis Limit.....	35
Jog Acceleration	36
Teach Move Z Clearance (How High the Tip Lifts in the Teach Mode).....	36
Point to Point Arc Jump	37
Park Position	37
Pause Status (Tip Pause Location)	38
Pre-Cycle Initialize (Auto-Initialize).....	38
Pre-Dispense Wait Time.....	39
Default Dispense Port (Dispense Port Output).....	39
Measurement Unit.....	40
Password Setup.....	40
Auto Purge	41
Language	42
Key Beep.....	42
Setting the Tool Offset.....	43
Setting Up Barcode Scanning	44
Setting the Dispenser Ports.....	45
Programming.....	46
Working with Programs and Commands.....	46
How to Switch from Run Mode to Teach Mode	46
How to Open and Edit a Program.....	47
How to Name a Program	48
How to Clear or Copy a Program.....	49
How to Jump to a Specific Address or Label	50
How to Insert or Delete a Command	50
How to Change a Group of Addresses (Group Edit).....	51
How to Set Mark Points	54
How to Adjust All Points in a Program (Program Offset)	55
How to Expand a Step & Repeat Command	56
How to Lock or Unlock the System	57
How to Upload / Download Programs Using the SVC USB Port	59
How to Create and Run a Program.....	60
Creating Patterns.....	62
How to Make a Dot	62
How to Make a Line	63
How to Make an Arc.....	65
How to Make a Circle.....	67
How to Fill an Area.....	68
How to Make an Array of Dots (Step & Repeat).....	70
Calibrating the Tip Height.....	72
Systems without a Tip Aligner.....	72
Systems with a Tip Aligner.....	74
Working with Inputs / Outputs.....	76
Enable or Disable an Input / Output.....	76
Automatically Switch Outputs ON	77
Set How Outputs Behave at the End of a Program	77

Continued on next page

Contents (continued)

Operation.....	78
Starting the System for Routine Operation.....	78
Running a Program by Scanning a Barcode	78
Pausing During a Dispense Cycle.....	79
Purging the System	79
Shutting Down the System.....	79
Part Numbers	79
Accessories	80
Safety Enclosures	80
Pre-Configured Output Cables.....	80
Fixture Plates	81
Start / Stop Box.....	81
Tip Aligner.....	81
Height Sensor	81
Mounting Brackets	82
Troubleshooting	83
Teach Pendant Error Messages	83
Diagnostic Checks (Diagnostic Menu).....	84
Restoring the System to the Factory Default Settings (Clear Memory).....	86
Technical Data.....	87
Dimensions	87
Robot Feet Mounting Hole Template	87
Wiring Diagrams	88
Dispenser Port	88
Ext. Control Port.....	88
I/O Port.....	89
RS232 Port (for Remote Communication).....	89
Example Input / Output Connections.....	90
Appendix A, Type Menu Reference.....	91
Appendix B, RS-232 Communication Protocol.....	115
Appendix C, DXF File Import Using TeachMotion DXF.....	117
Installing TeachMotion DXF and Connecting to the Robot	117
Overview of the TeachMotion DXF Software.....	118
Program Screen and Icons	119
Option Screen	122
DXF Screen and Icons	123
Modifying the DXF Import Options.....	125
Importing a DXF File	126
Appendix D, Height Sensor Setup and Use.....	130

Introduction

This manual provides installation, setup, programming, operation, and service information for all components of a Nordson EFD E Series automated dispensing system. Nordson EFD's automated dispensing systems dispense fluid in a preprogrammed pattern onto a workpiece. They are specifically designed and configured for use with Nordson EFD industrial syringe barrel and valve systems. Automated dispensing systems offer the flexibility of working either as a stand-alone system or as a key part of an automated solution and are easily integrated into in-line transfer systems, rotary tables, and pallet assembly lines.

The primary components of an automated dispensing system are the Teach Pendant (TP), the robot, and the dispensing valve components. The robot executes a program to dispense fluid from the valve in a specific pattern onto a workpiece. Programs are created and executed using the Teach Pendant. Material is dispensed through a Nordson EFD syringe barrel or valve system. A valve system may be contact or non-contact. Contact systems may dispense fluid through a needle or a dispensing tip. For the purposes of this manual, "dispensing tip" refers to either a needle or a tip.

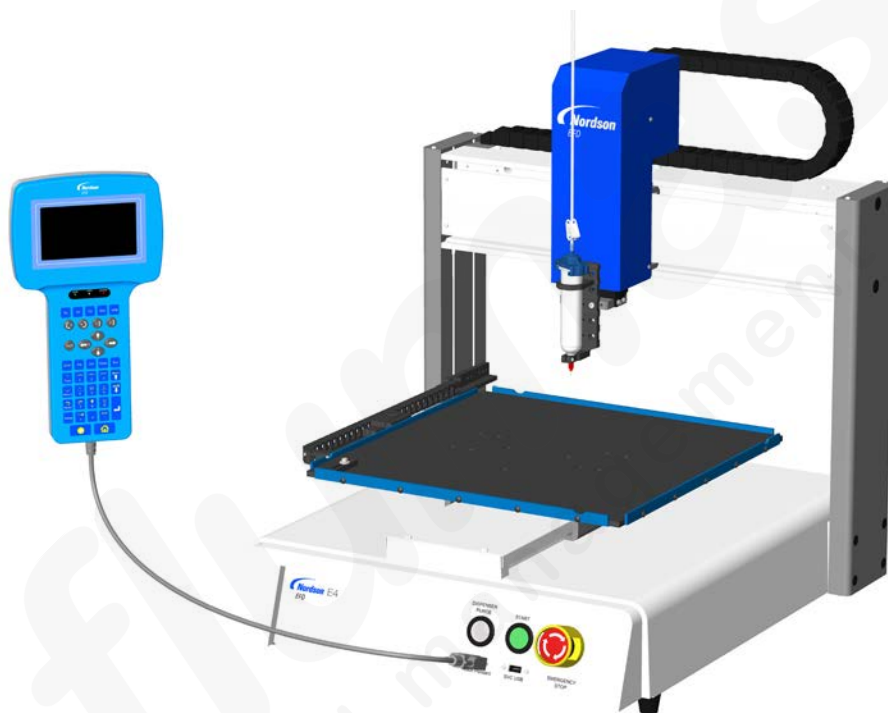

Nordson EFD Product Safety Statement

WARNING

The safety message that follows has a WARNING level hazard.
Failure to comply could result in death or serious injury.



ELECTRIC SHOCK

Risk of electric shock. Disconnect power before removing covers and / or disconnect, lock out, and tag switches before servicing electrical equipment. If you receive even a slight electrical shock, shut down all equipment immediately. Do not restart the equipment until the problem has been identified and corrected.

CAUTION

The safety messages that follow have a CAUTION level hazard.
Failure to comply may result in minor or moderate injury.



READ MANUAL

Read manual for proper use of this equipment. Follow all safety instructions. Task- and equipment-specific warnings, cautions, and instructions are included in equipment documentation where appropriate. Make sure these instructions and all other equipment documents are accessible to persons operating or servicing equipment.



MAXIMUM AIR PRESSURE

Unless otherwise noted in the product manual, the maximum air input pressure is 7.0 bar (100 psi). Excessive air input pressure may damage the equipment. Air input pressure is intended to be applied through an external air pressure regulator rated for 0 to 7.0 bar (0 to 100 psi).



RELEASE PRESSURE

Release hydraulic and pneumatic pressure before opening, adjusting, or servicing pressurized systems or components.



BURNS

Hot surfaces! Avoid contact with the hot metal surfaces of heated components. If contact can not be avoided, wear heat-protective gloves and clothing when working around heated equipment. Failure to avoid contact with hot metal surfaces can result in personal injury.

Nordson EFD Product Safety Statement (continued)

Halogenated Hydrocarbon Solvent Hazards

Do not use halogenated hydrocarbon solvents in a pressurized system that contains aluminum components. Under pressure, these solvents can react with aluminum and explode, causing injury, death, or property damage. Halogenated hydrocarbon solvents contain one or more of the following elements.

Element	Symbol	Prefix
Fluorine	F	“Fluoro-”
Chlorine	Cl	“Chloro-”
Bromine	Br	“Bromo-”
Iodine	I	“Iodo-”

Check the Safety Data Sheet (SDS) or contact your material supplier for more information. If you must use halogenated hydrocarbon solvents, contact your EFD representative for compatible EFD components.

High Pressure Fluids

High pressure fluids, unless they are safely contained, are extremely hazardous. Always release fluid pressure before adjusting or servicing high pressure equipment. A jet of high pressure fluid can cut like a knife and cause serious bodily injury, amputation, or death. Fluids penetrating the skin can also cause toxic poisoning.

WARNING

Any injury caused by high pressure liquid can be serious. If you are injured or even suspect an injury:

- Go to an emergency room immediately.
- Tell the doctor that you suspect an injection injury.
- Show the doctor the following note.
- Tell the doctor what kind of material you were dispensing.

Medical Alert — Airless Spray Wounds: Note to Physician

Injection in the skin is a serious traumatic injury. It is important to treat the injury surgically as soon as possible. Do not delay treatment to research toxicity. Toxicity is a concern with some exotic coatings injected directly into the bloodstream.

Qualified Personnel

Equipment owners are responsible for making sure that EFD equipment is installed, operated, and serviced by qualified personnel. Qualified personnel are those employees or contractors who are trained to safely perform their assigned tasks. They are familiar with all relevant safety rules and regulations and are physically capable of performing their assigned tasks.

Intended Use

Use of EFD equipment in ways other than those described in the documentation supplied with the equipment may result in injury to persons or damage to property. Some examples of unintended use of equipment include:

- Using incompatible materials.
- Making unauthorized modifications.
- Removing or bypassing safety guards or interlocks.
- Using incompatible or damaged parts.
- Using unapproved auxiliary equipment.
- Operating equipment in excess of maximum ratings.
- Operating equipment in an explosive atmosphere.

Nordson EFD Product Safety Statement (continued)

Regulations and Approvals

Make sure all equipment is rated and approved for the environment in which it is used. Any approvals obtained for Nordson EFD equipment will be voided if instructions for installation, operation, and service are not followed. If the equipment is used in a manner not specified by Nordson EFD, the protection provided by the equipment may be impaired.

Personal Safety

To prevent injury, follow these instructions:

- Do not operate or service equipment unless you are qualified.
- Do not operate equipment unless safety guards, doors, and covers are intact and automatic interlocks are operating properly. Do not bypass or disarm any safety devices.
- Keep clear of moving equipment. Before adjusting or servicing moving equipment, shut off the power supply and wait until the equipment comes to a complete stop. Lock out power and secure the equipment to prevent unexpected movement.
- Make sure spray areas and other work areas are adequately ventilated.
- When using a syringe barrel, always keep the dispensing end of the tip pointing towards the work and away from the body or face. Store syringe barrels with the tip pointing down when they are not in use.
- Obtain and read the Safety Data Sheet (SDS) for all materials used. Follow the manufacturer's instructions for safe handling and use of materials and use recommended personal protection devices.
- Be aware of less-obvious dangers in the workplace that often cannot be completely eliminated, such as hot surfaces, sharp edges, energized electrical circuits, and moving parts that cannot be enclosed or otherwise guarded for practical reasons.
- Know where emergency stop buttons, shutoff valves, and fire extinguishers are located.
- Wear hearing protection to protect against hearing loss that can be caused by exposure to vacuum exhaust port noise over long periods of time.

Fire Safety

To prevent a fire or explosion, follow these instructions:

- Shut down all equipment immediately if you notice static sparking or arcing. Do not restart the equipment until the cause has been identified and corrected.
- Do not smoke, weld, grind, or use open flames where flammable materials are being used or stored.
- Do not heat materials to temperatures above those recommended by the manufacturer. Make sure heat monitoring and limiting devices are working properly.
- Provide adequate ventilation to prevent dangerous concentrations of volatile particles or vapors. Refer to local codes or the SDS for guidance.
- Do not disconnect live electrical circuits when working with flammable materials. Shut off power at a disconnect switch first to prevent sparking.
- Know where emergency stop buttons, shutoff valves, and fire extinguishers are located.

Nordson EFD Product Safety Statement (continued)

Preventive Maintenance

As part of maintaining continuous trouble-free use of this product, Nordson EFD recommends the following simple preventive maintenance checks:

- Periodically inspect tube-to-fitting connections for proper fit. Secure as necessary.
- Check tubing for cracks and contamination. Replace tubing as necessary.
- Check all wiring connections for looseness. Tighten as necessary.
- Clean: If a front panel requires cleaning, use a clean, soft, damp rag with a mild detergent cleaner. DO NOT USE strong solvents (MEK, acetone, THF, etc.) as they will damage the front panel material.
- Maintain: Use only a clean, dry air supply to the unit. The equipment does not require any other regular maintenance.
- Test: Verify the operation of features and the performance of equipment using the appropriate sections of this manual. Return faulty or defective units to Nordson EFD for replacement.
- Use only replacement parts that are designed for use with the original equipment. Contact your Nordson EFD representative for information and advice.

Important Disposable Component Safety Information

All Nordson EFD disposable components, including syringe barrels, cartridges, pistons, tip caps, end caps, and dispense tips, are precision engineered for one-time use. Attempting to clean and re-use components will compromise dispensing accuracy and may increase the risk of personal injury.

Always wear appropriate protective equipment and clothing suitable for your dispensing application and adhere to the following guidelines:

- Do not heat syringe barrels or cartridges to a temperature greater than 38° C (100° F).
- Dispose of components according to local regulations after one-time use.
- Do not clean components with strong solvents (MEK, acetone, THF, etc.).
- Clean cartridge retainer systems and barrel loaders with mild detergents only.
- To prevent fluid waste, use Nordson EFD SmoothFlow™ pistons.

Action in the Event of a Malfunction

If a system or any equipment in a system malfunctions, shut off the system immediately and perform the following steps:

1. Disconnect and lock out system electrical power. If using hydraulic and pneumatic shutoff valves, close and relieve pressure.
2. For Nordson EFD air-powered dispensers, remove the syringe barrel from the adapter assembly. For Nordson EFD electro-mechanical dispensers, slowly unscrew the barrel retainer and remove the barrel from the actuator.
3. Identify the reason for the malfunction and correct it before restarting the system.

Disposal

Dispose of equipment and materials used in operation and servicing according to local codes.

Nordson EFD Product Safety Statement (continued)

Equipment-Specific Safety Information

The following safety information is specific to Nordson EFD automated dispensing systems.

European Community

To meet the requirements of the European Community (CE) safety directives, the robot must be placed in an enclosure. The enclosure prevents an operator from entering the robot's work area and generates an emergency stop signal if the door switch is opened while the robot is running.

WARNING

Install the input / output safety plug only to bypass the door switch. When this plug is installed, the installer assumes all safety liability.

Installation Location

Do not store, install, or operate the robot in a location where it is exposed to the following:

- Temperatures lower or higher than 0–40 °C (50–104 °F) or humidity lower or higher than 20–95%
- Direct sunlight
- Electrical noise
- Flammable or corrosive gases
- Dust or iron powder
- Sources of splashing water, oil, or chemicals
- Radioactive materials, magnetic fields, or vacuum rooms

Power and Grounding

- Connect the robot and accessories to a properly grounded power source.
- Ensure that the system is connected to the correct voltage.

Operation and Service

- Turn on the dust collection system before operating the robot.
- Do not drop or spill foreign objects or material, such as screws or liquids, into the robot.
- Do not overload the robot.
- Do not touch any part of the robot while it is running. Load and unload workpieces or material only when the robot is stopped.
- Disconnect and lock out power to the system before changing fixtures or tooling.
- Use only a neutral detergent for cleaning. Do not use alcohol, benzene, or thinner.
- Refer to the maintenance instructions for a recommended maintenance schedule, detailed cleaning instructions, and available tools and supplies for servicing the robot.

Specifications

NOTE: Specifications and technical details are subject to change without prior notification.

Item / Model	E2	E3	E4
Number of axes	3	3	3
Maximum working area (X / Y / Z)	200 / 200 / 50 mm (8 / 8 / 2")	300 / 300 / 100 mm (12 / 12 / 4")	400 / 400 / 100 mm (16 / 16 / 4")
Workpiece payload	5.0 kg (11.0 lb)	10.0 kg (22.0 lb)	10.0 kg (22.0 lb)
Tool payload	3.0 kg (6.6 lb)	5.0 kg (11.0 lb)	5.0 kg (11.0 lb)
Weight	21.0 kg (46.3 lb)	39.5 kg (87.1 lb)	44.5 kg (98.1 lb)
Dimensions	370 _W x 510 _H x 414 _D mm (15 _W x 20 _H x 16 _D ")	490 _W x 644 _H x 519 _D mm (19 _W x 25 _H x 20 _D ")	590 _W x 644 _H x 617 _D mm (23 _W x 25 _H x 24 _D ")
Maximum speed (XY / Z)	500 / 250 mm/s (20 / 10"/s)	800 / 320 mm/s (31 / 13"/s)	800 / 320 mm/s (31 / 13"/s)
Drive system	3-phase micro-stepping motor	3-phase micro-stepping motor	3-phase micro-stepping motor
Memory capacity	1–99 programs 1–9,999 points per program	1–99 programs 1–9,999 points per program	1–99 programs 1–9,999 points per program
Data storage	USB	USB	USB
General purpose I/O	8 inputs / 8 outputs	8 inputs / 8 outputs	8 inputs / 8 outputs
Drive method	PTP and CP	PTP and CP	PTP and CP
Dispensing controller	External	External	External
Input AC (to power supply)	100–240 VAC, ±10%, 50/60Hz, 20 Amp maximum, 200 W	100–240 VAC, ±10%, 50/60Hz, 20 Amp maximum, 320 W	100–240 VAC, ±10%, 50/60Hz, 20 Amp maximum, 320 W
Interpolation	3 axes (3D space)	3 axes (3D space)	3 axes (3D space)
Repeatability*	±0.008 mm/axis	±0.008 mm/axis	±0.008 mm/axis
Working temperature	10–40° C (50–104° F)	10–40° C (50–104° F)	10–40° C (50–104° F)
Teach Pendant	Included	Included	Included
Tip alignment	Optional	Optional	Optional
Height detection	Optional	Optional	Optional
Approvals	CE, RoHS, WEEE, China RoHS		

*Repeatability results may vary depending on the method of measurement.

Specifications (continued)

Item / Model	E5	E6
Number of axes	3	3
Maximum working area (X / Y / Z)	500 / 500 / 150 mm (20 / 20 / 6")	620 / 500 / 150 mm (24 / 20 / 6")
Workpiece payload	10.0 kg (22.0 lb)	10.0 kg (22.0 lb)
Tool payload	5.5 kg (7.7 lb)	5.0 kg (11.0 lb)
Weight	47.0 kg (103.6 lb)	50.0 kg (110.2 lb)
Dimensions	690 _W x 814 _H x 718 _D mm (27 _W x 32 _H x 28 _D ")	808 _W x 812 _H x 718 _D mm (32 _W x 32 _H x 28 _D ")
Maximum speed (XY / Z)	800 / 320 mm/s (31 / 13"/s)	800 / 320 mm/s (31 / 13"/s)
Drive system	3-phase micro-stepping motor	3-phase micro-stepping motor
Memory capacity	1–99 programs 1–9,999 points per program	1–99 programs 1–9,999 points per program
Data storage	USB	USB
General purpose I/O	8 inputs / 8 outputs	8 inputs / 8 outputs
Drive method	PTP and CP	PTP and CP
Dispensing controller	External	External
Input AC (to power supply)	100–240 VAC, ±10%, 50/60Hz, 20 Amp maximum, 320 W	100–240 VAC, ±10%, 50/60Hz, 20 Amp maximum, 320 W
Interpolation	3 axes (3D space)	3 axes (3D space)
Repeatability*	±0.008 mm/axis	±0.008 mm/axis
Working temperature	10–40° C (50–104° F)	10–40° C (50–104° F)
Teach Pendant	Included	Included
Tip alignment	Optional	Optional
Height detection	Optional	Optional
Approvals	CE, RoHS, WEEE, China RoHS	
*Repeatability results may vary depending on the method of measurement.		

Specifications (continued)

RoHS标准相关声明 (China RoHS Hazardous Material Declaration)

产品名称 Part Name	有害物质及元素 Toxic or Hazardous Substances and Elements					
	铅 Lead (Pb)	汞 Mercury (Hg)	镉 Cadmium (Cd)	六价铬 Hexavalent Chromium (Cr6)	多溴联苯 Polybrominated Biphenyls (PBB)	多溴联苯醚 Polybrominated Diphenyl Ethers (PBDE)
外部接口 External Electrical Connectors	X	0	0	0	0	0
<p>0: 表示该产品所含有的危险成分或有害物质含量依照EIP-A, EIP-B, EIP-C的标准低于SJ/T11363-2006 限定要求。 Indicates that this toxic or hazardous substance contained in all the homogeneous materials for this part, according to EIP-A, EIP-B, EIP-C is below the limit requirement in SJ/T11363-2006.</p> <p>X: 表示该产品所含有的危险成分或有害物质含量依照EIP-A, EIP-B, EIP-C的标准高于SJ/T11363-2006 限定要求。 Indicates that this toxic or hazardous substance contained in all the homogeneous materials for this part, according to EIP-A, EIP-B, EIP-C is above the limit requirement in SJ/T11363-2006.</p>						

WEEE Directive



This equipment is regulated by the European Union under WEEE Directive (2012/19/EU). Refer to www.nordsonefd.com/WEEE for information about how to properly dispose of this equipment.

Operating Features

Component Identification

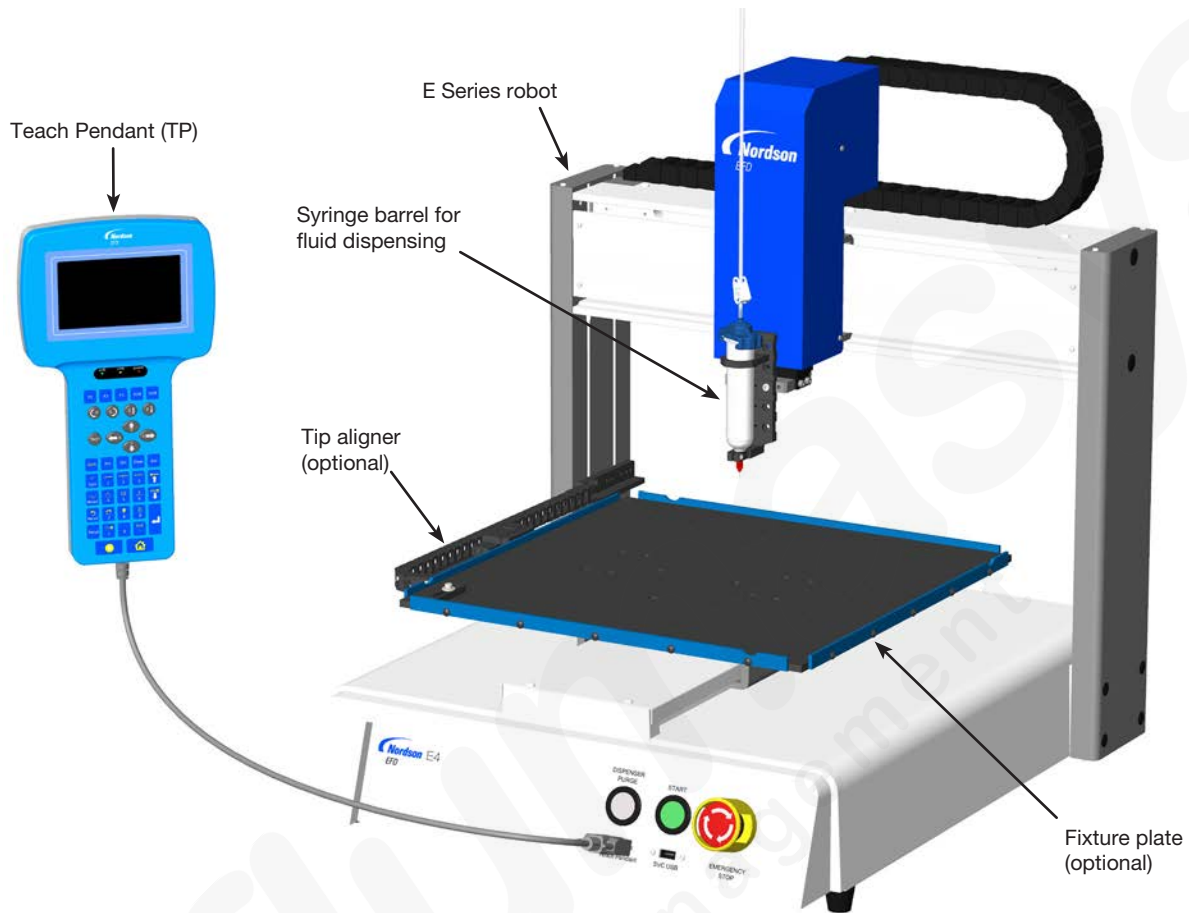

Front Panel

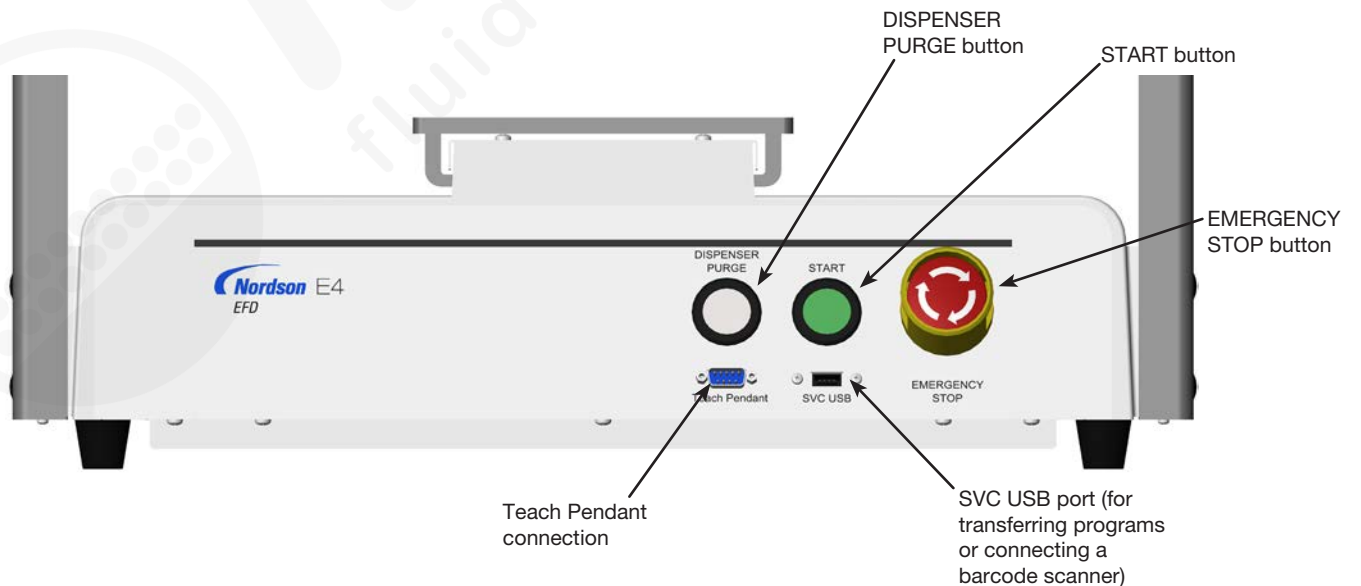

Back Panel

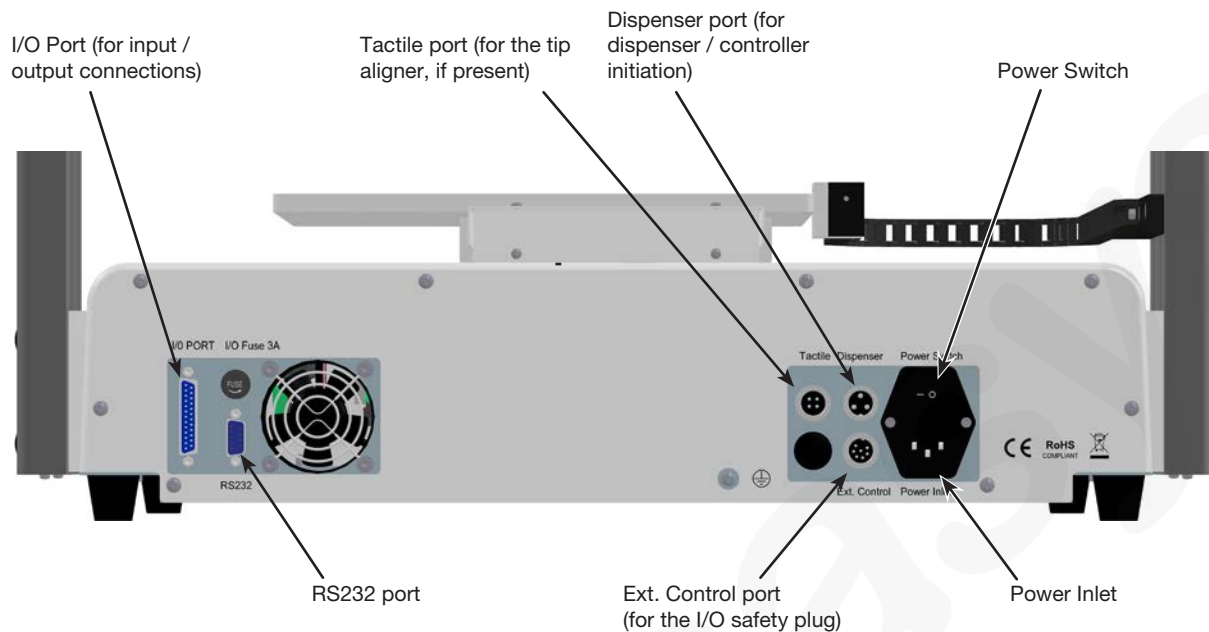

Installation

Use this section in tandem with the Quick Start Guide and the valve system manuals to install all components of the system.

Unpack the System Components

CAUTION

Unpacking the robot requires a minimum of two people. Do not attempt to lift the robot without assistance.

1. Remove all system components and ship-with items from the packaging.
2. With assistance, carefully lift the robot by its base and transfer it to a stable workbench. Never lift the robot by its cross member.

NOTE: All units are shipped from the factory with foam protectors that secure the worktable to the X-axis and the Z-head to prevent movement and damage during shipment. Nordson EFD recommends retaining all packing material for use if the robot is shipped or moved in the future.

3. Remove the protective foam covers and tape.
4. Double-check the shipping box to ensure you have removed everything.

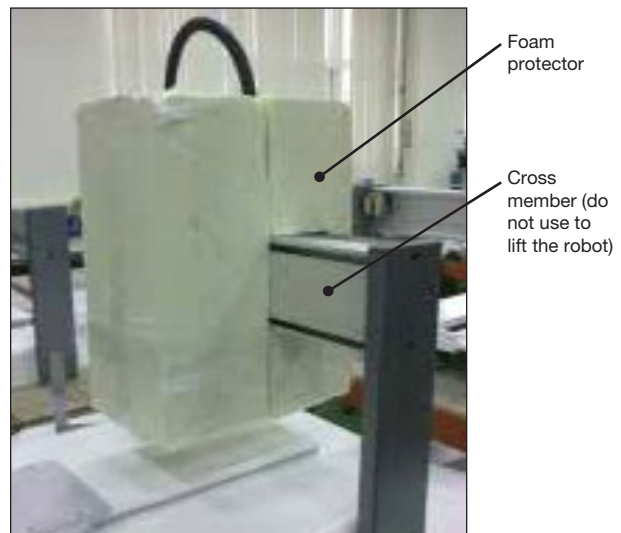





Position the Robot and Install and Connect Components

Refer to the Quick Start Guide and to this section as needed to install the system components and make connections.

NOTES:

- The components of an automated dispensing system vary. Steps for a complete system with all available components are provided in this manual and in the Quick Start Guide. Perform only the steps that apply to your system.
- If the system is being used in the European Community, the robot is shipped with an enclosure or light curtain that (1) prevents an operator from entering the robot's work area and (2) generates an emergency stop signal if the enclosure door switch is opened while the robot is running.

Applicability	Item	Components to Install or Connect	Installation Tasks
All models	Input / output safety plug (SHORTED)		<input type="checkbox"/> Connect the input / output safety plug to the Ext. Control port to bypass the door switch. <div style="background-color: #e0f0ff; padding: 5px; text-align: center;">  CAUTION </div> Install this plug only if you want to bypass the door switch. When this plug is installed, the installer assumes all safety liability.
All models	Teach Pendant		<input type="checkbox"/> Connect the Teach Pendant cable to the Teach Pendant port on the front of the robot.
If present	Tip aligner (optional)		<input type="checkbox"/> Install the tip aligner. <input type="checkbox"/> Connect the cable to the Tactile port on the back of the robot.
All models	Dispensing valve components	As applicable	<input type="checkbox"/> Mount the syringe barrel or dispensing valve holder (as applicable) on the Z axis; choose mounting holes that allow a maximum workpiece clearance but also allow the dispensing tip to reach all areas on the workpiece where dispensing is required. <input type="checkbox"/> Refer to the dispensing equipment manuals for all other dispensing system installation steps.

Prepare the Work Surface or Fixture Plate

Prepare the robot work surface or fixture plate for secure placement of the workpiece. All Nordson EFD automated dispensing systems include a standard fixture plate. Other fixture plate sizes are available. Refer to “Accessories” on page 80.

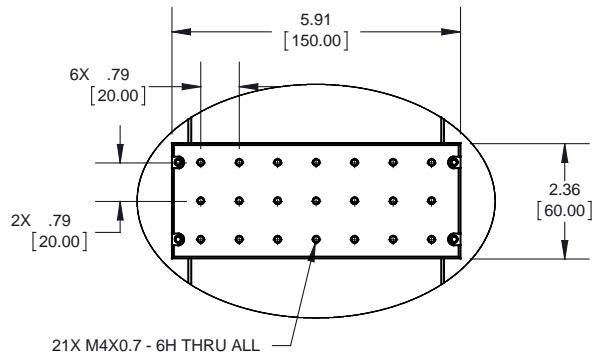

200 x 200 standard fixture plate

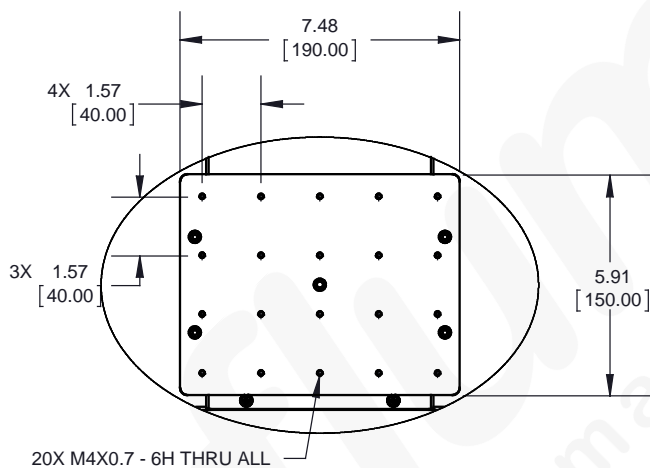

Larger fixture plate (300 x 300, 400 x 400, or 500 x 500)

Connect Inputs / Outputs (Optional)

All automated dispensing systems provide 8 standard inputs and 8 standard outputs. Connect input / output wiring to the I/O PORT connection on the back of the robot. For a wiring diagram, refer to “I/O Port” on page 89. There are several ways to use the system inputs / outputs. Refer to “Working with Inputs / Outputs” on page 76 for additional information on inputs / outputs.

Connect a Barcode Scanner (Optional)

To use a barcode scanner to run programs by scanning a barcode, connect a barcode scanner to the SVC USB port on the front of the robot. Additional information on barcode scanning is located later in this manual, under “Setting Up Barcode Scanning” on page 44.

Power On the System

After the system is fully installed, including the dispensing system components, switch on the system to verify the installation.

1. Make sure the following installation tasks are complete:
 - All applicable system components are installed (refer to “Installation” on page 16).
 - The input / output safety plug is installed (if applicable).
 - The Teach Pendant cable is connected to the Teach Pendant port on the front of the robot.
 - The EMERGENCY STOP button on the front panel of the robot is not depressed.

2. Switch on the robot.

The robot moves to the factory-set home position and the system is ready.

3. Enable the dispensing system, including the valve controller. Refer to the dispensing equipment manuals as needed.

4. Press F1 > TEACH/RUN to enter the Teach Mode.

NOTE: The Teach Pendant cable should already be connected to the Teach Pendant port on the front of the robot.

5. Refer to the following sections to set up the system and create programs for your applications:

- “Concepts” on page 20
- “Overview of the Teach Pendant” on page 22
- “Setup” on page 34
- “Programming” on page 46

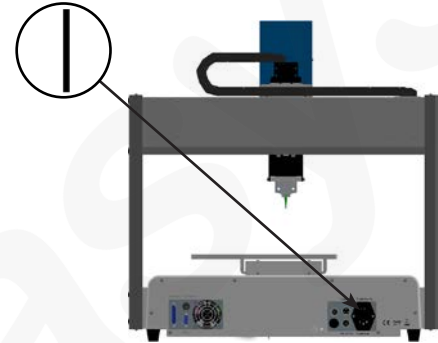

Teach Pendant port

Concepts

Before creating any programs, make sure you understand the concepts explained in this section.

About Programs and Commands

A program is a set of commands stored as a file. Each command is stored in the file as a numbered address. Commands can be subdivided into the following command types:

- A setup command sets a program-level parameter, such as an XYZ coordinate or the Z clearance height.
- A dispense command is tied to an XYZ coordinate and automatically sends a signal to the dispensing system to execute the dispense command.

When the robot executes a program, it steps through each address in sequence and executes the command contained in that address. If an address contains a setup command, the system registers that command. If an address contains a dispense command, the robot moves the axes to the location specified for that command and then performs the dispense command.

Dispense commands are the building blocks of patterns. To program a dispense command, the dispensing tip is jogged to the desired XYZ location and then a dispense command is registered for that location. This action is repeated until the desired dispensing pattern is complete. Several examples are provided below.

Setup commands dictate how dispense commands will be executed. Nordson EFD recommends inserting setup commands at the beginning of a program.

Dispense Command Examples

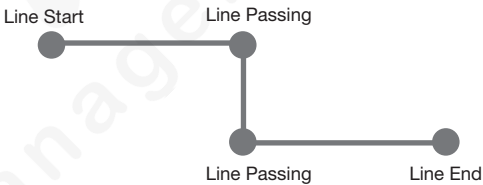
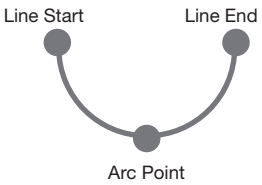
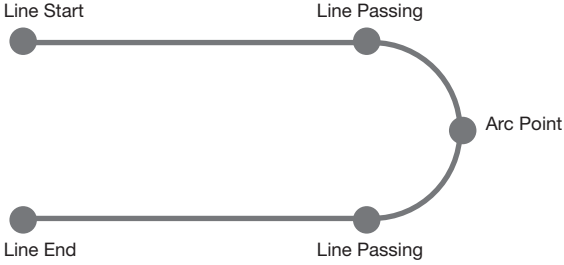
Commands	Resulting Pattern
To program the robot to dispense a dot of fluid, an XYZ location is registered as a DISPENSE DOT command.	 DISPENSE DOT
To program the robot to dispense a bead of fluid along a linear path, the XYZ location of the start of the line is registered as a LINE START command. The locations where the tip changes direction are registered as LINE PASSING commands. The location where the bead of fluid ends is registered as a LINE END command.	
To dispense a bead of fluid in an arc, the XYZ location of the start of the bead is registered as a LINE START command. The high point of the arc is registered as an ARC POINT command. The end of the arc is registered as a LINE END command.	
Lines and arcs can also be combined to dispense a bead of fluid along a complex path.	

About Programs and Commands (continued)

Best Practices for Programming

- Insert setup commands (including Acceleration, Dispense Port, and Z Clearance) at the beginning of the program.
- Insert dispense commands after setup commands.
- Insert the End Program command at the end of all programs.
- Name your programs (refer to “How to Name a Program” on page 48).

About Tip Height

Tip height is (1) the distance between the bottom of the tip and the workpiece for contact applications or (2) the distance between the bottom of the nozzle and the workpiece for non-contact applications. The tip height is also known as the Z clearance.

The tip height must be calibrated and then recalibrated as needed to compensate for slight variations in height that occur when changes are made to the system, primarily nozzle or tip change-out. If your system includes the optional tip aligner, you can automatically update the tip height at any time using the Auto Needle Adjust feature.

The tip height should be recalibrated as follows:

- At initial startup.
- Any time a component on the Z axis (such as the syringe barrel) is moved.
- Any time a dispensing tip or nozzle is changed.
- Any time the payload or workpiece changes.



About Mark Points

Mark Points are specific points on a workpiece that are set using the Mark Point command. The system uses Mark Points to adjust all the XY values in a program based on any changes made to the position or orientation of a workpiece. This adjustment is accomplished through the Program Offset function.

Overview of the Teach Pendant

This section explains how to use the Teach Pendant and provides an overview of all the Teach Pendant keys and menus. This information is provided for your reference as needed. To set up the system and create dispensing programs, refer to “Setup” on page 34 and to “Programming” on page 46.

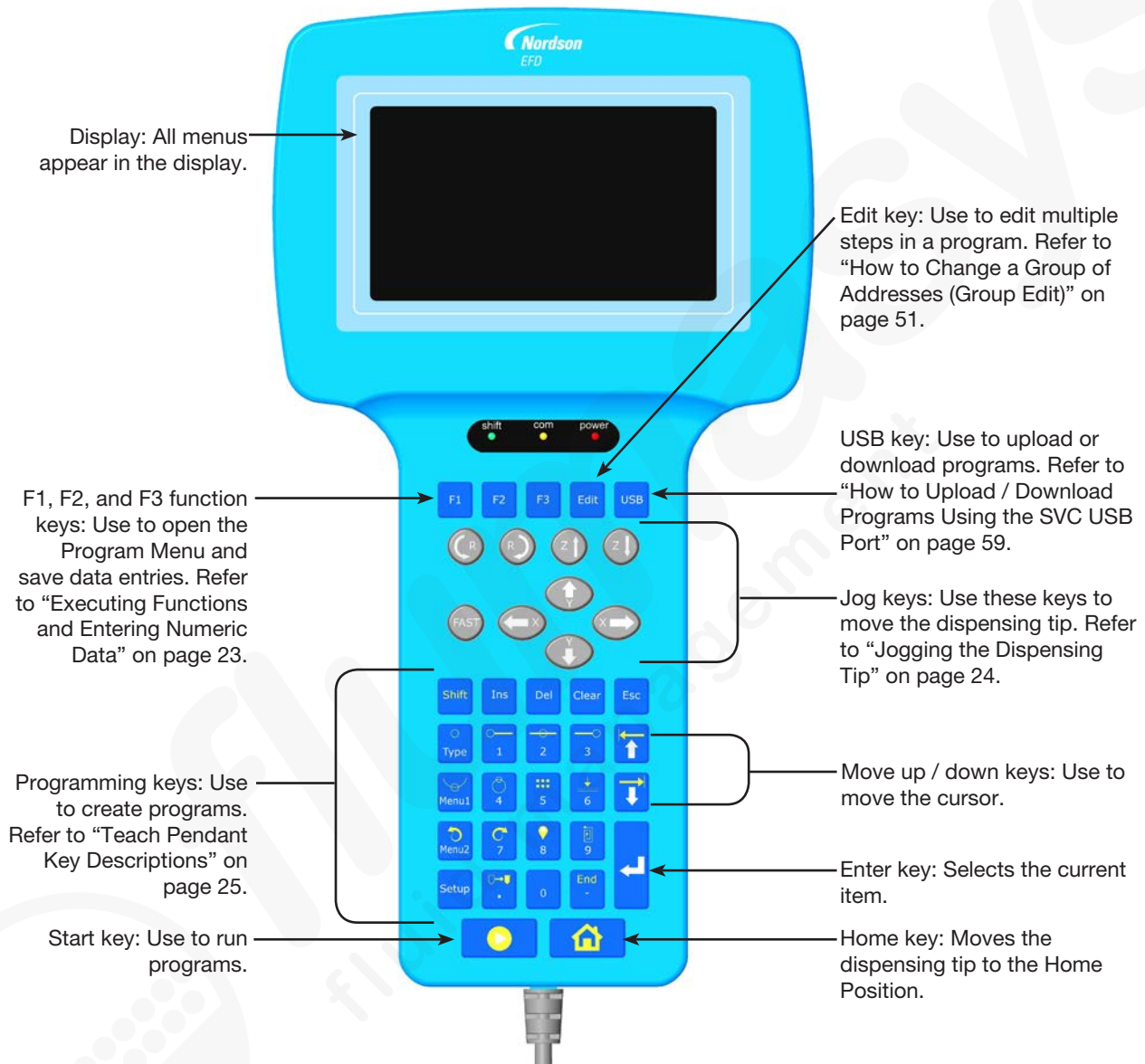

Run Mode vs. Teach Mode

The system has two modes of operation: Run and Teach.

In the Run Mode, you can:

- View a list of programs and select a program.
- Run a program.
- Reset the counter (this function is password-protected).
- Update all the XYZ values in a program if the location and / or orientation of a workpiece changes.
- Perform a manual or automatic tip height calibration (required after a tip or needle change).

In the Teach Mode, you can:

- View or change system settings.
- Calibrate the tip height.
- Set up inputs/outputs.
- Create, edit, copy, move, and name programs.
- Test-run programs.
- Upload and download programs using the SVC USB port.
- Perform hardware and software diagnostic testing.

When you switch on the robot, the system is in the Run Mode. To switch to the Teach Mode, refer to “How to Switch from Run Mode to Teach Mode” on page 46.

Executing Functions and Entering Numeric Data

Execute functions by pressing keys either individually or consecutively:

- When you press a single key, the Teach Pendant executes the function shown in white. For example, when you press the Type key, the Type menu opens.

EXAMPLE: Press  to open the Type menu.

- To execute the function shown in yellow at the top of a key, press and release the Shift key, then press the desired key. For example, to select the Dispense Dot command, press the Shift key, then press the Type key.

EXAMPLE: Press  >  to insert a Dispense Dot command.



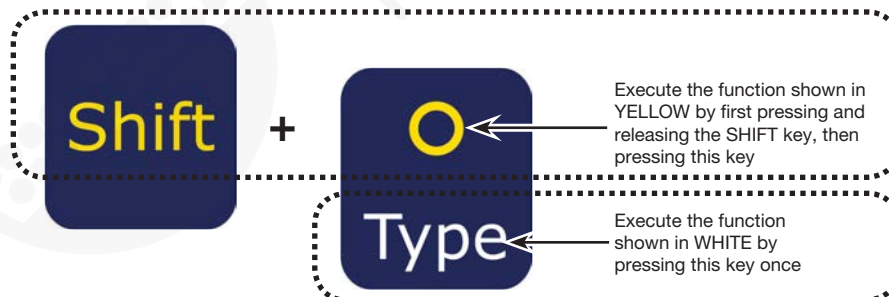

When a number is required, the Teach Pendant automatically switches to numeric entry mode. The number keys have a white number on the bottom of the key.

EXAMPLE: Press  to enter the number 1.

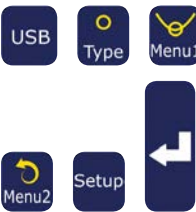

EXAMPLE: Press  >  >  to enter the number 1.5.



















Navigating the Menus

TP Key	Function
	Press F1 to open the Program Menu.
	In the Teach Mode, press the USB, TYPE, MENU1, MENU2, or SETUP key to open the corresponding menu. The ENTER key opens the Type menu.
	Press ESC to exit out of any menu.
	Within a menu, use the MOVE UP and MOVE DOWN arrow keys to move either vertically or horizontally through menu items.
	Use the left and right X jog keys to go to the next page or to the previous page of a menu.
	Press ENTER to select the current item.















Jogging the Dispensing Tip

TP Key	Function
	Jog (move) the dispensing tip by pressing the X, Y, or Z ARROW keys. A single press steps the tip in the direction indicated on the key. Pressing and holding jogs the tip at slow speed.
	<p>Press and hold the FAST key while simultaneously pressing any X, Y, or Z jog key to move the robot at full speed.</p> <p>To accelerate the jog speed of the robot, press and hold any X, Y, or Z jog key to start robot movement. While the robot is moving, press and hold the FAST key to begin ramping up the speed.</p> <p>To decelerate the jog speed of the robot, release the FAST key while still pressing and holding any X, Y, or Z jog key. The robot speed will begin to ramp down.</p>

Teach Pendant Key Descriptions

Key Name	Key	Function
F1		Selects the option shown on the display; use of this key depends on which menu is currently displayed
F2		Selects the option shown on the display; use of this key depends on which menu is currently displayed
F3		Selects the option shown on the display; use of this key depends on which menu is currently displayed
Edit		Opens the Group Edit menu
USB		Opens the USB menu
Shift		If pressed and released before pressing another key, enables the secondary function of the second key (shown in yellow)
Ins		Inserts an address before the current address in a program
Del		Deletes the current address in a program
Clear		One press clears a single character; press and hold clears the field
Esc		Exits the current operation
Type / Dispense Dot		Opens the Type menu SHIFT > TYPE inserts a Dispense Dot command
1 / Line Start		Enters a 1
		SHIFT > 1 inserts a Line Start command
2 / Line Passing		Enters a 2
		SHIFT > 2 inserts a Line Passing command
3 / Line End		Enters a 3
		SHIFT > 3 inserts a Line End command
Move Up / Move Left		Scrolls up or left through selections or addresses
		SHIFT > ARROW UP pages up through addresses
Menu1 / Arc Point		Opens Menu1
		SHIFT > MENU1 inserts an Arc Point command

White	Teach or Run Mode
Dark Gray	Teach Mode only

Key Name	Key	Function
4 / Circle		Enters a 4
		SHIFT > 4 inserts a Circle command
5 / Step & Repeat		Enters a 5
		SHIFT > 5 inserts a Step & Repeat command
6 / Z Clearance		Enters a 6
		SHIFT > 6 inserts a Z Clearance command
Move Down / Move Right		Scrolls down or right through selections or addresses
		SHIFT > ARROW DOWN pages down through addresses
Menu2 / Undo		Opens Menu2
		SHIFT > MENU2 undoes the last change to a program
7 / Redo		Enters a 7
		SHIFT > 7 redoes the last change to a program
8 / Label		Enters an 8
		SHIFT > 8 inserts a Label command
9 / Fill Area		Enters a 9
		SHIFT > 9 inserts a Fill Area command
Setup		Opens the Setup menu
Decimal Point / Move		Enters a decimal point
		SHIFT > Decimal Point moves the tip to a specified address
0		Enters a 0
Minus / End Program		Toggles a value from positive to negative
		SHIFT > End inserts an End Program command
Enter		Enters or confirms data entries or selections or Opens the Type menu
Start		Runs the currently open program
Home		Moves the tip to the Home Position (0, 0, 0)

Teach Pendant Menu Structure

NOTE: These menus are accessible only in the Teach Mode. Refer to “How to Switch from Run Mode to Teach Mode” on page 46.

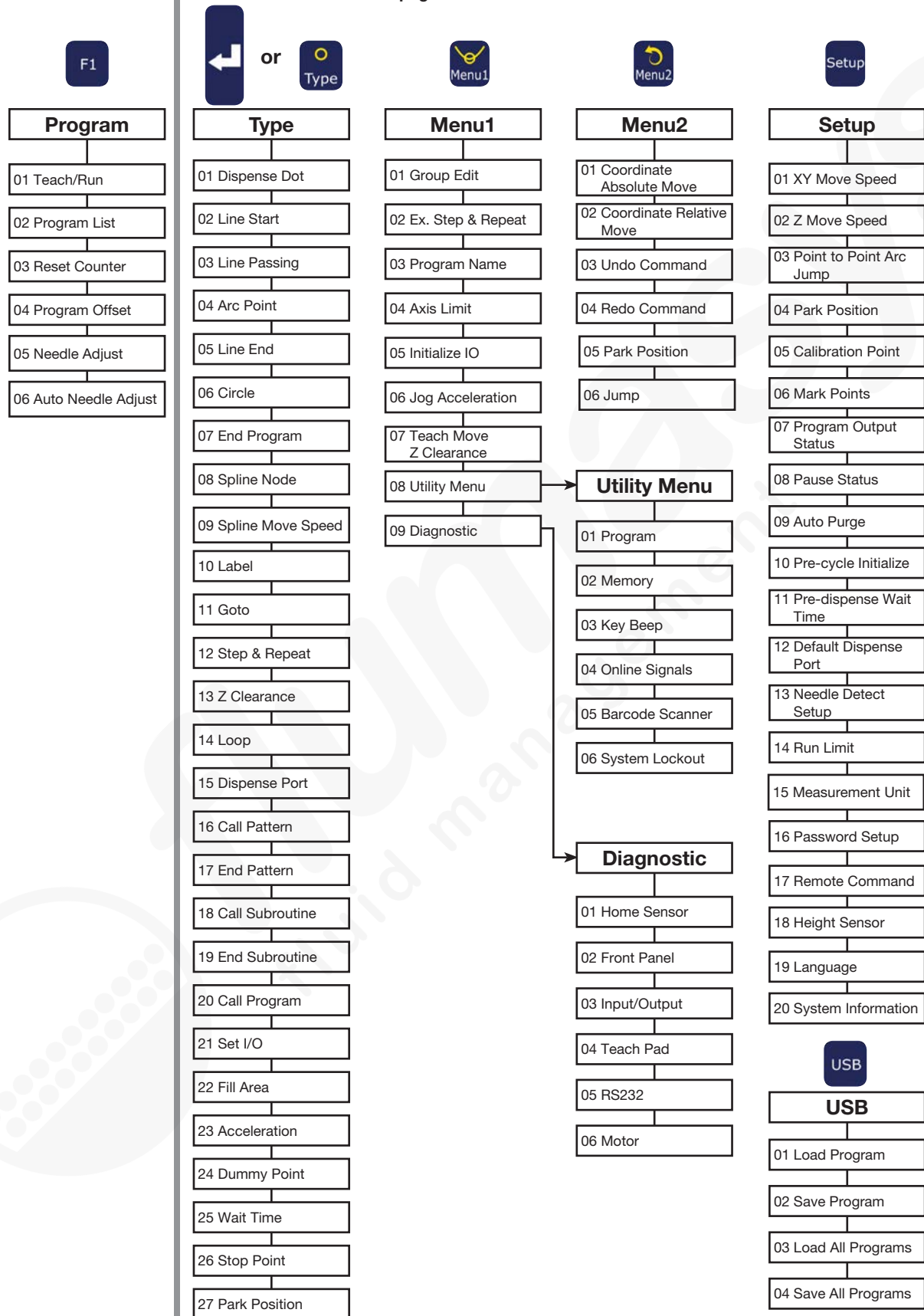

Teach Pendant Menu Item Descriptions

This section provides a brief description of all the Teach Pendant menu items for quick reference as needed.

Program Menu

```
[PROGRAM MENU]          1/1
01 Teach/Run
02 Program List
03 Reset Counter
04 Program Offset
05 Needle Adjust
06 Auto Needle Adjust
```

Menu Item	Description
01 Teach/Run	Used to toggle between the Teach Mode and the Run Mode. NOTE: If a program is locked, the Teach Mode is password-protected.
02 Program List	Used to select a program number from 1 to 99.
03 Reset Counter	Resets the dispense cycle count. NOTE: This function is password-protected.
04 Program Offset	Adjusts the XY coordinates for all dispense commands in a program when you enter offset values for each axis. For this function to work properly, the program must contain two Mark Points. Refer to “How to Set Mark Points” on page 54 and to “How to Adjust All Points in a Program (Program Offset)” on page 55.
05 Needle Adjust	Calibrates the tip height after a dispensing tip or syringe barrel change on systems without the optional tip aligner. For this function to work properly, you must set a Calibration Point. Refer to “Calibrating the Tip Height” on page 72.
06 Auto Needle Adjust	Calibrates the tip height after a dispensing tip or syringe barrel change on systems with the optional tip aligner. For this function to work properly, you must calibrate the tip aligner. Refer to “Calibrating the Tip Height” on page 72.

Teach Pendant Menu Item Descriptions (continued)

Menu 1

[MENU 1] 1/2 01 Group Edit 02 Ex. Step & Repeat 03 Program Name 04 Axis Limit 05 Initialize Output 06 Jog Acceleration 07 Teach Move Z Clearance	[MENU 1] 2/2 08 Utility Menu 09 Diagnostic
---	--

Menu Item	Description
01 Group Edit	Used to modify a selected group of addresses in a program; available selections are Copy, Delete, Move, Line Speed, Dispense Time, Z Value, Point Offset, Offset To, Mirror Points, and Rotate Points.
02 Ex. Step & Repeat	Expands all the commands contained in a Step & Repeat command (can only be undone using the Undo command).
03 Program Name	Used to modify the name of the current program.
04 Axis Limit	Sets the working area travel limits (X, Y, and Z axes): <ul style="list-style-type: none"> • E2 axis limit maximums: 200, 200, 50 mm • E3 axis limit maximums: 300, 300, 100 mm • E4 axis limit maximums: 400, 400, 100 mm • E5 axis limit maximums: 500, 500, 150 mm • E6 axis limit maximums: 620, 500, 150 mm
05 Initialize Output	Used to specify which outputs (1–8) switch ON at the beginning of a program.
06 Jog Acceleration	Sets the FAST jog speed; available selections are Low, Medium, or High.
07 Teach Move Z Clearance	Sets how high the tip lifts as it moves between points in the Teach Mode. Refer to “Teach Move Z Clearance (How High the Tip Lifts in the Teach Mode)” on page 36.
08 Utility Menu	Refer to “Utility Menu” on page 29.
09 Diagnostic	Refer to “Diagnostic Menu” on page 30.

Teach Pendant Menu Item Descriptions (continued)

Utility Menu

[UTILITY]	1/1
01 Program	
02 Memory	
03 Key Beep	
04 OnLine Signals	
05 Barcode Scanner	
06 System Lockout	

Menu Item	Description
01 Program	Used to clear the current program or copy the current program to another program number.
02 Memory	CLEAR MEMORY clears all data from every program on the Teach Pendant. TOOL OFFSET changes all of a program's XYZ values by the XYZ values entered as an offset. NOTE: This function is password-protected.
03 Key Beep	Enables or disables the key press beep.
04 Online Signals	Enables or disables whether the system sends status output signals from outputs 5–8 when the system is operating in the Run Mode. Available status output signals are as follows: <ul style="list-style-type: none"> • Out 5: Emergency • Out 6: Running • Out 7: Standby • Out 8: Need Start Signal The default setting is OFF (disabled).
05 Barcode Scanner	Enables or disables the ability to run programs using a barcode scanner (Run Mode only). NOTE: The barcode scanner must be connected to the SVC USB port on the front of the robot.
06 System Lockout	Locks or unlocks the current program. When a program is locked, it cannot be modified. NOTE: This function is password-protected.

Teach Pendant Menu Item Descriptions (continued)

Diagnostic Menu

```
[DIAGNOSTIC] 1/1
01 Home Sensor
02 Front Panel
03 Input/Output
04 Teach Pad
05 RS232
06 Motor
```

Menu Item	Description
01 Home Sensor	Checks the home sensors for each axis as you manually move the robot Z axis or fixture plate.
02 Front Panel (and tip aligner)	Checks the status of the robot's front panel buttons (START, DISPENSER PURGE, and EMERGENCY STOP); also checks the status of the sensor on the optional tip aligner.
03 Input/Output	Checks the status of each input and output signal and the dispenser signal.
04 Teach Pad	Checks the status of the each of the Teach Pendant keys.
05 RS232	Checks the status of the RS232 port.
06 Motor	Checks the motor axis movement; when selected, the motors move back and forth 10 mm.

Menu 2

```
[MENU 2] 1/1
01 Coordinate Absolute Move
02 Coordinate Relative Move
03 Undo Command
04 Redo Command
05 Go To Park Position
06 Jump
```

Menu Item	Description
01 Coordinate Absolute Move	Used to manually input coordinates to move the tip to a new location relative to the origin position (0, 0, 0).
02 Coordinate Relative Move	Used to manually input coordinates to move the tip to a new location relative to its current position.
03 Undo Command	Undoes the last command; this can also be done by pressing SHIFT > Menu2.
04 Redo Command	Redoes the last command; this can also be done by pressing SHIFT > 7.
05 Go To Park Position	Moves the tip to the Park Position. Park Position is the same as the Home Position (0, 0, 0) unless modified (see Park Position under the Setup menu).
06 Jump	Jumps to a specified address or label number within the dispense program (useful for long programs).

Teach Pendant Menu Item Descriptions (continued)

Setup Menu

<p>[SETUP] 1/3</p> <p>01 XY Move Speed</p> <p>02 Z Move Speed</p> <p>03 Point to Point Arc Jump</p> <p>04 Park Position</p> <p>05 Calibration Point</p> <p>06 Mark Points</p> <p>07 Program Output Status</p>	<p>[SETUP] 2/3</p> <p>08 Pause Status</p> <p>09 Auto Purge</p> <p>10 Pre-cycle Initialize</p> <p>11 Pre-dispense Wait Time</p> <p>12 Default Dispense Port</p> <p>13 Needle Detect Setup</p> <p>14 Run Limit</p>
<p>[SETUP] 3/3</p> <p>15 Measurement Unit</p> <p>16 Password Setup</p> <p>17 Remote Command</p> <p>18 Height Sensor</p> <p>19 Language</p> <p>20 System Information</p>	

Menu Item	Description
01 XY Move Speed	Sets the speed of the of X and Y axis movement: <ul style="list-style-type: none"> • Maximum XY speed: 500 (mm/s) (E2); 800 (mm/s) (E3, E4, E5, E6) • Default: 100 (mm/s)
02 Z Move Speed	Sets the speed of the of Z axis movement: <ul style="list-style-type: none"> • Maximum Z speed: 250 (mm/s) (E2); 320 (mm/s) (E3, E4, E5, E6) • Default: 50 (mm/s)
03 Point to Point Arc Jump	Enables or disables tip movement in an arc motion between dispense patterns: <ul style="list-style-type: none"> • 1 Enable: The tip moves in an arc motion. • 2 Disable (default): The tip moves in a square motion.
04 Park Position	Sets the Park Position XYZ coordinates. When the Park Position command is used in a dispense program, the tip moves to the set Park Position. The tip also moves to the Park Position at the end of a dispense program. <ul style="list-style-type: none"> • Default: 0, 0, 0 (mm)
05 Calibration Point	Sets a reference point that is used by the system to perform the Needle Adjust function.
06 Mark Points	Sets two reference points that are used by the system to perform the Program Offset function.
07 Program Output Status	Enables or disables how outputs function after a program ends: <ul style="list-style-type: none"> • 1 Enable: The system keeps outputs ON after a program ends. • 2 Disable (default): The system allows outputs to switch OFF after a program ends.
08 Pause Status	Sets the position that the tip moves to when you press the START button to pause the current dispense cycle: <ul style="list-style-type: none"> • 1 Park Position (default): The tip moves to the user-specified Park Position. • 2 Stand: The tip stays at the current position.
09 Auto Purge	Used to set up parameters for purging. Refer to “Auto Purge” on page 41. <ul style="list-style-type: none"> • Purge time: 100.0 (s) maximum • Wait time: 999 (s) maximum

Continued on next page

Teach Pendant Menu Item Descriptions (continued)

Menu Item	Description
10 Pre-cycle Initialize	Enables or disables a pre-cycle initialization before every dispense cycle: <ul style="list-style-type: none"> • 1 Enable (default): The tip always returns to the Home Position before beginning a dispense cycle (also know as auto-initialize). • 2 Disable: The next dispense cycle begins at the first point in the dispense program without returning to the Home Position to initialize.
11 Pre-dispense Wait Time	Sets a wait time that occurs prior to the start of each dispense command within a program (both dot and line dispensing). <ul style="list-style-type: none"> • Default: 0 (s) • Range: 0.0–9999.9 (s)
12 Default Dispense Port	Sets the output port for the dispensing valve. Refer to “Setting the Dispenser Ports” on page 45. <ul style="list-style-type: none"> • Default: 0
13 Needle Detect Setup (only systems with the optional tip aligner)	Sets the tip coordinates for the optional tip aligner. Refer to “Set a Calibration Point (Initial Setup for Auto Needle Adjust)” on page 74.
14 Run Limit	Sets a limit for how many dispense cycles the system can complete in the Run Mode. When the system reaches the Run Limit, you must reset the counter (Reset Counter under the Program menu) to run additional dispense cycles. <ul style="list-style-type: none"> • Default: 0 • Maximum: 99,999
15 Measurement Unit	Used to specify how units of measure are displayed. <ul style="list-style-type: none"> • 1 mm (default) • 2 inch
16 Password Setup	Used to change the system password. Refer to “Password Setup” on page 40. <ul style="list-style-type: none"> • Default: blank (no password protection) <p>NOTE: This function is password-protected.</p>
17 Remote Command	Enables or disables the ability of the system to accept commands through the RS232 serial communication port on the back of the robot when the system is connected to an external PC/PLC. <ul style="list-style-type: none"> • 1 Enable: The system accepts command through the RS232 port. • 2 Disable (default): The system cannot accept command through the RS232 port. <p>NOTE: Refer to “Appendix B, RS-232 Communication Protocol” on page 115 for information on using RS-232 communication.</p>
18 Height Sensor	Used only when the optional height sensor is installed. Refer to “Appendix D, Height Sensor Setup and Use” on page 130 for all information related to the height sensor.
19 Language	Used to set the language. Refer to “Language” on page 42.
20 System Information	Displays the system information, including the robot model and the Teach Pendant software version.

Teach Pendant Menu Item Descriptions (continued)

Type Menu

[TYPE] 1/4	[TYPE] 2/4
01 Dispense Dot	08 Spline Node
02 Line Start	09 Spline Move Speed
03 Line Passing	10 Label
04 Arc Point	11 Goto
05 Line End	12 Step & Repeat
06 Circle	13 Z Clearance
07 End Program	14 Loop

[TYPE] 3/4	[TYPE] 4/4
15 Dispense Port	22 Fill Area
16 Call Pattern	23 Acceleration
17 End Pattern	24 Dummy Point
18 Call Subroutine	25 Wait Time
19 End Subroutine	26 Stop Point
20 Call Program	27 Park Position
21 Set I/O	28 Height Sensor

Refer to “Appendix A, Type Menu Reference” on page 91 for a detailed explanation of the Type menu items.

USB Menu

[USB] 1/1
01 Load Program
02 Save Program
03 Load All Programs
04 Save All Programs

You can connect a USB drive to the SVC USB port on the front of the robot to upload or download programs to or from the robot. Refer to “How to Upload / Download Programs Using the SVC USB Port” on page 59.



Menu Item	Description
01 Load Program	Uploads a *.NDN file selected from the USB drive to the current program or a destination program number.
02 Save Program	Saves the current program to the USB drive as a *.NDN file.
03 Load All Programs	Uploads a *.PKG file from the USB drive to load all the dispense programs on the drive. Existing dispense programs are overwritten.
04 Save All Programs	Saves all the dispense programs on the robot to the USB drive as a *.PKG file.

Setup

After installation and before creating any programs, perform these setup procedures as applicable for your automated dispensing system.

Switching from Run Mode to Teach Mode

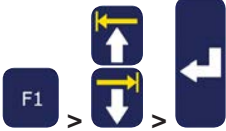
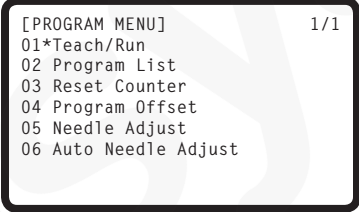
When the system is switched on, the default mode of operation is the Run Mode. To modify system settings, the system must be in the Teach Mode. Refer to “Run Mode vs. Teach Mode” on page 23 for more information on the modes of operation.

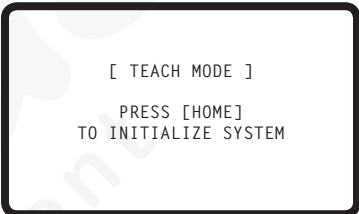
#	Key Press	Step	Teach Pendant Display
1		<ul style="list-style-type: none"> • Press F1. • MOVE UP / DOWN to TEACH/RUN. • Press ENTER. 	
2		<ul style="list-style-type: none"> • Press HOME. If prompted, enter a password. 	

Setting System Parameters

The factory system settings are appropriate for most applications. Use these procedures as needed to view or change system settings. Important system settings include:



- **XY or Z Move Speed:** The speed at which the dispensing tip moves along the X, Y, or Z axes.
- **Jog Acceleration:** How the robot accelerates when the FAST button is pressed (applies to program creation in the Teach Mode).

Refer to “Setup Menu” on page 31 for default and maximum / minimum settings.

Setting System Parameters (continued)

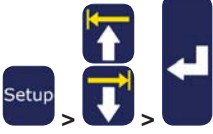

XY Move Speed or Z Move Speed

XY Move Speed is how fast the tip travels along the XY axis. Z Move Speed is how fast the tip moves up or down the Z axis.

#	Key Press	Step	Teach Pendant Display
1		<ul style="list-style-type: none"> Press SETUP. MOVE UP / DOWN to XY MOVE SPEED or Z MOVE SPEED. Press ENTER. 	<pre>[SETUP] 1/3 01*XY Move Speed 02 Z Move Speed 03 Point to Point Arc Jump 04 Park Position 05 Calibration Point 06 Mark Points 07 Program Output Status</pre>
2		<ul style="list-style-type: none"> Enter the desired value. <ul style="list-style-type: none"> XY Move Speed range: 0–800 mm/s Z Move Speed range: 0–320 mm/s Press F1 to save or exit. 	<pre>XY Move Speed ----- Current: 100.0 mm/s New: - [F1] OK</pre>

Axis Limit



Axis Limit sets how far the dispensing tip is allowed to move within the XYZ working area. If a command includes a point that is outside the specified axis limits, an error occurs.

#	Key Press	Step	Teach Pendant Display
1		<ul style="list-style-type: none"> Press MENU1. MOVE UP / DOWN to AXIS LIMIT. Press ENTER. 	<pre>[MENU 1] 1/2 01 Group Edit 02 Ex. Step & Repeat 03 Program Name 04*Axis Limit 05 Initialize Output 06 Jog Acceleration 07 Teach Move Z Clearance</pre>
2		<ul style="list-style-type: none"> Enter the desired values. <ul style="list-style-type: none"> E2 maximums: 200, 200, 50 mm E3 maximums: 300, 300, 100 mm E4 maximums: 400, 400, 100 mm E5 maximums: 500, 500, 150 mm E6 maximums: 620, 500, 150 mm Press F1 to save or exit. <p>or</p> <ul style="list-style-type: none"> Press F3 to return to the factory default settings. 	<pre>Axis Limit ----- X Limit: 300.00 mm Y Limit: 300.00 mm Z Limit: 150.00 mm [F1] OK [F3] Default</pre>

Setting System Parameters (continued)

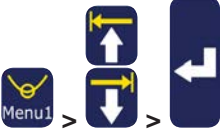
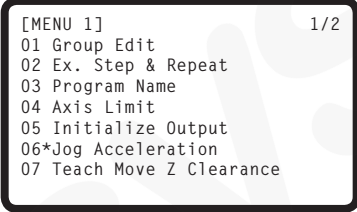

Jog Acceleration

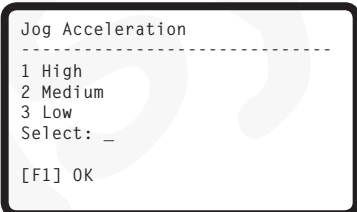
Jog Acceleration is how the robot accelerates when the FAST button is pressed (applies to program creation in the Teach Mode).

#	Key Press	Step	Teach Pendant Display
1		<ul style="list-style-type: none"> Press MENU1. MOVE UP / DOWN to JOG ACCELERATION. Press ENTER. 	
2		<ul style="list-style-type: none"> Press 1 HIGH, 2 MEDIUM, or 3 LOW. Press F1 to save or exit. 	

Teach Move Z Clearance (How High the Tip Lifts in the Teach Mode)

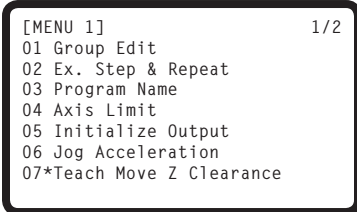

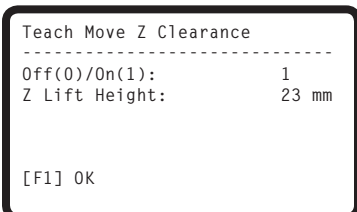
When testing programs, save time by limiting how high the tip raises as it moves from point to point. This is done by adjusting the setting for Teach Move Z Clearance. This setting is in effect only when the system is in the Teach Mode.

#	Key Press	Step	Teach Pendant Display
1		<ul style="list-style-type: none"> Press MENU1. MOVE UP / DOWN to TEACH MOVE Z CLEARANCE. Press ENTER. 	
2		<ul style="list-style-type: none"> Press 0 or 1 to switch the Teach Move Z Clearance function OFF or ON. Press the number keys to enter the maximum Z Lift Height. Press F1 to save and exit. <p>When Teach Move Z Clearance is switched ON, the tip raises no higher than the value specified for Z Lift Height (relative to the current point) as the robot moves between dispense points in the Teach Mode.</p> <p>When Teach Move Z Clearance is switched OFF, the system ignores the setting for Z Lift Height.</p> <p>Range: 0 to the Z axis travel limit</p>	

Setting System Parameters (continued)

Point to Point Arc Jump

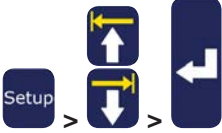
Point to Point Arc Jump is the motion the tip makes as it moves from point to point. The default is up, across, and down. The optional movement is in an arc motion, which can result in faster program cycle times. The distance the tip travels up and down is based on the Z Clearance.



#	Key Press	Step	Teach Pendant Display
1		<ul style="list-style-type: none"> Press SETUP. MOVE UP / DOWN to POINT TO POINT ARC JUMP. Press ENTER. 	<pre>[SETUP] 1/3 01 XY Move Speed 02 Z Move Speed 03*Point to Point Arc Jump 04 Park Position 05 Calibration Point 06 Mark Points 07 Program Output Status</pre>
2		<ul style="list-style-type: none"> Press 1 ENABLE to make the tip move in an arc shape. Press 2 DISABLE to make the tip move in an up, across, and down shape. Press F1 to save or exit. 	<pre>Point to Point Arc Jump Disable ----- 1 Enable 2 Disable Select: _ [F1] OK</pre>

Park Position

Park Position is the XYZ location the tip moves to when any of the following occurs:

- A program includes a Park Position command.
- A program is paused (the START button was pressed and Pause Status is set to Park Position).
- At the end of a dispense cycle.

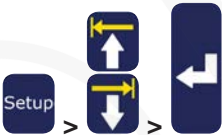
NOTE: When the EMERGENCY STOP button is pressed, the robot moves to the home position (0, 0, 0).



#	Key Press	Step	Teach Pendant Display
1		<ul style="list-style-type: none"> Press SETUP. MOVE UP / DOWN to PARK POSITION. Press ENTER. 	<pre>[SETUP] 1/3 01 XY Move Speed 02 Z Move Speed 03 Point to Point Arc Jump 04*Park Position 05 Calibration Point 06 Mark Points 07 Program Output Status</pre>
2		<ul style="list-style-type: none"> To move the tip to the current Park Position, press F2. To change the Park Position, press F3, jog the tip to the desired Park Position location, and press F1. Press F1 to save or exit. 	<pre>Park Position ----- X: 000.00 mm Y: 000.00 mm Z: 000.00 mm [F1] OK [F2] Move [F3] Jog</pre>

Setting System Parameters (continued)

Pause Status (Tip Pause Location)

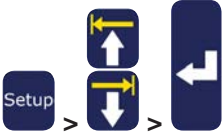

When you press the START button on the front of the robot, the system stops dispensing and the tip stays at its current location or moves based on the setting for Pause Status.

NOTE: If the system is paused during dispensing, the system shuts off the dispenser, compromising pattern integrity.

#	Key Press	Step	Teach Pendant Display
1		<ul style="list-style-type: none"> Press SETUP. MOVE UP / DOWN to PAUSE STATUS. Press ENTER. 	<pre>[SETUP] 2/3 08*Pause Status 09 Auto Purge 10 Pre-cycle Initialize 11 Pre-dispense Wait Time 12 Default Dispense Port 13 Needle Detect Setup 14 Run Limit</pre>
2		<ul style="list-style-type: none"> Press 1 PARK POSITION to cause the tip move to the Park Position. Press 2 STAND to cause the tip to stop at the next programmed position. Press F1 to save or exit. 	<pre>Pause Status Park Position ----- 1 Park Position 2 Stand Select: _ [F1] OK</pre>

Pre-Cycle Initialize (Auto-Initialize)

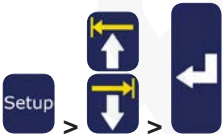

If Pre-cycle Initialize is enabled, the system automatically moves the dispensing tip to the Home Position and initializes between each dispense cycle.

#	Key Press	Step	Teach Pendant Display
1		<ul style="list-style-type: none"> Press SETUP. MOVE UP / DOWN to PRE-CYCLE INITIALIZE. Press ENTER. 	<pre>[SETUP] 2/3 08 Pause Status 09 Auto Purge 10*Pre-cycle Initialize 11 Pre-dispense Wait Time 12 Default Dispense Port 13 Needle Detect Setup 14 Run Limit</pre>
2		<ul style="list-style-type: none"> Press 1 ENABLE to initialize between dispense cycles. Press 2 DISABLE for no initialization between dispense cycles. Press F1 to save or exit. 	<pre>Pre-cycle Initialize Disable ----- 1 Enable 2 Disable Select: _ [F1] OK</pre>

Setting System Parameters (continued)

Pre-Dispense Wait Time

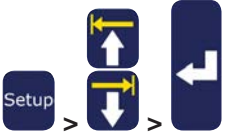
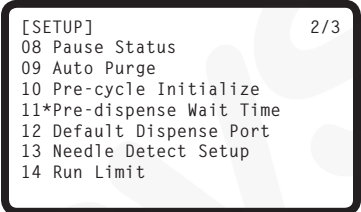

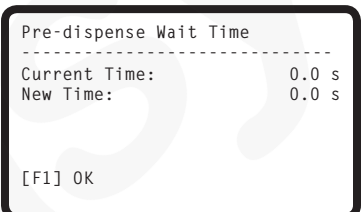
Pre-dispense Wait Time is a wait time that occurs prior to the start of each dispense command within a program.

#	Key Press	Step	Teach Pendant Display
1		<ul style="list-style-type: none"> Press SETUP. MOVE UP / DOWN to PRE-DISPENSE WAIT TIME. Press ENTER. 	
2		<ul style="list-style-type: none"> Enter the desired value. Press F1 to save or exit. 	

Default Dispense Port (Dispense Port Output)

For most systems, a cable from the dispenser is connected to the Dispenser port on the back of the robot. The default dispense output port for this connection is 0. The dispense port can also be set to any of the optional I/O ports (ports 1 to 8).

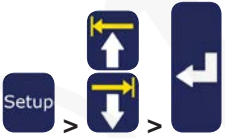
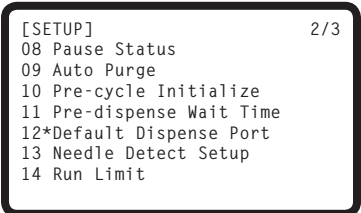

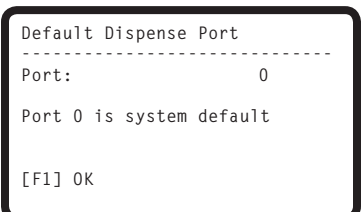
NOTE: If the system includes a PICO® dispense valve cable, outputs 1 or 2 can be used. For multiple dispensers, use the Dispense Port command (under the Type menu) within the dispense program to set the port for the dispenser. Refer to “15 Dispense Port” on page 104 for more information on the Dispense Port command.

#	Key Press	Step	Teach Pendant Display
1		<ul style="list-style-type: none"> Press SETUP. MOVE UP / DOWN to DEFAULT DISPENSE PORT. Press ENTER. 	
2		<ul style="list-style-type: none"> Enter the desired value (0 to 8). NOTE: Port 0 refers to the Dispenser port connector on the rear panel of the robot. Press F1 to save or exit. 	

Setting System Parameters (continued)

Measurement Unit

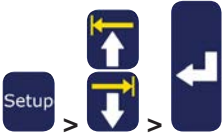
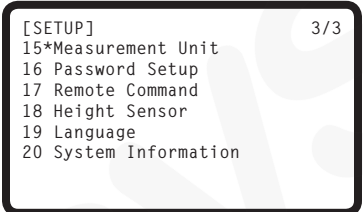
The System can display units of measure in millimeters or inches.

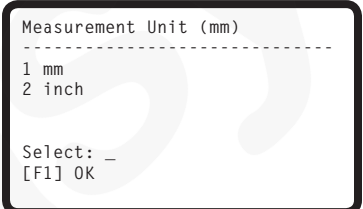



#	Key Press	Step	Teach Pendant Display
1		<ul style="list-style-type: none"> Press SETUP. MOVE UP / DOWN to MEASUREMENT UNIT. Press ENTER. 	
2		<ul style="list-style-type: none"> Press 1 to display units in mm. Press 2 to display units in inches. Press F1 to save or exit. 	

Password Setup

Use Password Setup under the Setup menu to change the default password. The following functions are password protected: Reset Counter, Memory, System Lockout, and Password Setup. If you want to protect all functions accessible in the Teach Mode, change the default password to a new password.

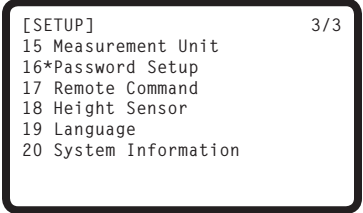
NOTES:

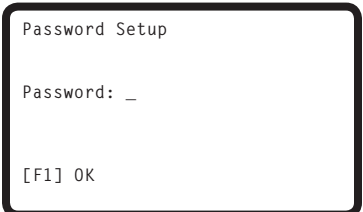
- The default password is blank.
- If the password is forgotten, use the master password (00000000) to gain access.
- A password can include only numbers and is limited to eight digits.

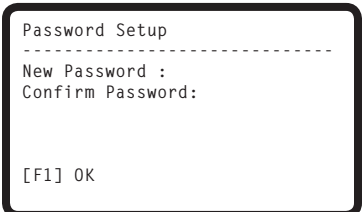

#	Key Press	Step	Teach Pendant Display
1		<ul style="list-style-type: none"> Press SETUP. MOVE UP / DOWN to PASSWORD SETUP. Press ENTER. 	
2		<ul style="list-style-type: none"> Enter the current password. The default password is blank (no digits). Press ENTER. 	
3		<ul style="list-style-type: none"> Type the new password and press ENTER, type the new password again to confirm, then press F1. or To restore password protection to the default settings, clear all characters from the New Password field and press F1. 	

Setting System Parameters (continued)

Auto Purge

You can set up the system to automatically purge after it has been idle for a specified period of time. When the system purges, the tip moves to the park position and purges material according to the parameters set for Auto Purge. This command is useful for two-part materials that have a very short pot life.

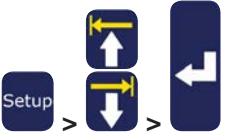
The Auto Purge function is set for the current program. Auto Purge is turned off by default (Wait Time and Purge Time are both set to 0). Enter non-zero values to enable this feature. Auto Purge is in effect when the system is in the Run Mode.

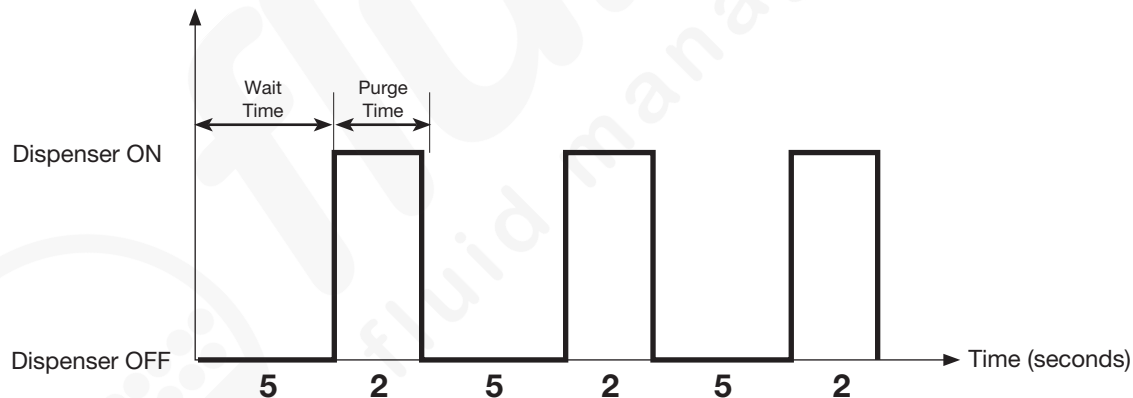

#	Key Press	Step	Teach Pendant Display
1		<ul style="list-style-type: none"> Press SETUP. MOVE UP / DOWN to AUTO PURGE. Press ENTER. 	<pre>[SETUP] 2/3 08 Pause Status 09*Auto Purge 10 Pre-cycle Initialize 11 Pre-dispense Wait Time 12 Default Dispense Port 13 Needle Detect Setup 14 Run Limit</pre>
2		<ul style="list-style-type: none"> Enter values for the Auto Purge parameters: <ul style="list-style-type: none"> Purge Time — How long the system purges in intervals of 0.1 seconds (in this example). Wait Time — How long the system must be idle (robot START button not pressed) before an Auto Purge begins. <p>A diagram of Purge Time and Wait Time is provided below.</p> Press F1 to save or exit. 	<pre>Auto Purge Setup ----- Purge Time: 0.1 s Wait Time: 0.1 s [F1] OK</pre>



Example of an Auto Purge setup when Wait Time is 5 seconds and Purge Time is 2 seconds

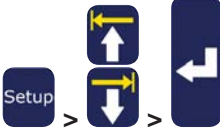
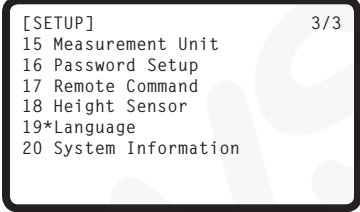

Setting System Parameters (continued)

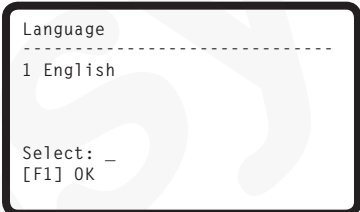
Language

#	Key Press	Step	Teach Pendant Display
1		<ul style="list-style-type: none"> Press SETUP. MOVE UP / DOWN to LANGUAGE. Press ENTER. 	
2		<ul style="list-style-type: none"> Enter the number for the desired language. Press F1 to save or exit. 	

Key Beep

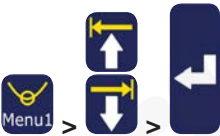
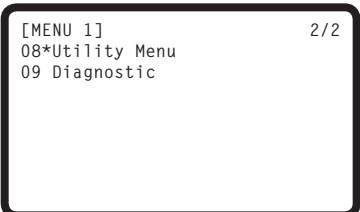
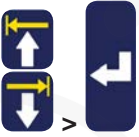
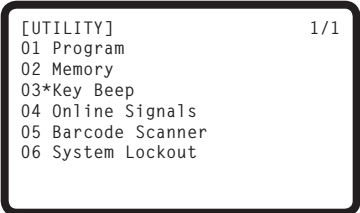
The key beep sound occurs when a Teach Pendant key is pressed. The default is ON. Follow this procedure to turn the key beep OFF.

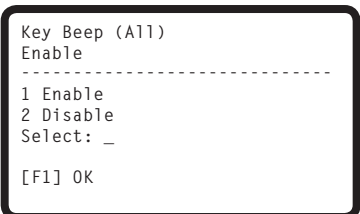





#	Key Press	Step	Teach Pendant Display
1		<ul style="list-style-type: none"> Press MENU1. MOVE UP / DOWN to UTILITY MENU. Press ENTER. 	
2		<ul style="list-style-type: none"> MOVE UP / DOWN to KEY BEEP. Press ENTER. 	
3		<ul style="list-style-type: none"> Press 1 ENABLE to switch the key beep ON. Press 2 DISABLE to switch the key beep OFF. Press F1 to save or exit. 	

Setting the Tool Offset

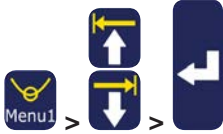
If your system includes a camera or similar accessory installed on the Z axis, follow this procedure to teach the system the offset values. The offset values represent the distance between the tip and the accessory.

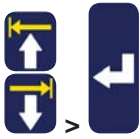
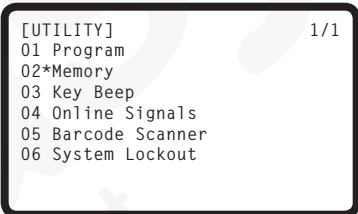
PREREQUISITES

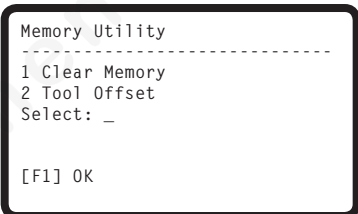
- ❑ The accessory and the valve system are properly installed.
- ❑ The XYZ offset values (in mm) needed for this function are calculated.

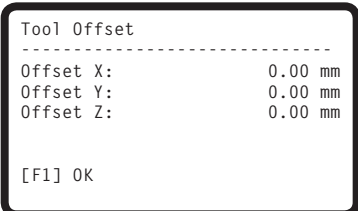
#	Key Press	Step	Teach Pendant Display
1		<ul style="list-style-type: none"> • Press MENU1. • MOVE UP / DOWN to UTILITY MENU. • Press ENTER. 	
2		<ul style="list-style-type: none"> • MOVE UP / DOWN to MEMORY. • Press ENTER. 	
3		<ul style="list-style-type: none"> • Press 2 TOOL OFFSET. • Press F1 to enter the offset values that represent the distance between the tip and the accessory. 	
4		<ul style="list-style-type: none"> • Enter the offset values (in mm) for Offset X, Offset Y, and Offset Z. <p>Refer to the example below to see how to calculate the offset values.</p>	

Example of How to Calculate Tool Offset Values

In this example, the accessory is a camera that has been installed on the robot. Using the camera, create a dispense dot on the workpiece and record the XYZ coordinates. Next, move the tip to the same location on the workpiece, create a dispense dot, and record the XYZ coordinates. Calculate the difference between the two coordinates to obtain the offset values as follows:

- Accessory XYZ values: 10 20 5
- Tip XYZ values: 8 22 15
- Offset XYZ values: 2 -2 -10 (the differences between the accessory XYZ values and the tip XYZ values)

Setting Up Barcode Scanning

In the Run Mode, programs can be executed using a barcode scanner. To do this, the barcode scanner must be properly configured and barcode scanning must be enabled.

Configuring the Barcode Scanner

Use a personal computer to configure the barcode scanner before connecting it to the SVC USB port. Refer to the barcode scanner manufacturer's documentation when configuring the barcode scanner. Observe the following guidelines:

- Configure the scanner to read target symbology (for example, Code-128, Code-93, Code-39, etc.).
- Configure the scanner to terminate a scan with carriage return (CR) enabled.
- The program to be executed by the robot will have a label (Program Name) that matches the barcode that will be scanned. Ensure that the barcode includes the exact Program Name.
- A barcode can consist of any combination of the uppercase letters A-Z, digits 0–9, and any number of the following special characters: dash (-), period (.), or underscore (_). The maximum length of characters is fifteen.

Enabling or Disabling Barcode Scanning





For the system to execute a program using a barcode scanner, the following must occur:

- A program number must have a program name. Refer to “How to Name a Program” on page 48.
- A barcode that includes the exact same name as the program to be executed must be generated (refer to “Configuring the Barcode Scanner” above).
- A properly configured barcode scanner must be connected to the SVC USB port on the front of the robot (refer to “Configuring the Barcode Scanner” above).
- Barcode scanning must be enabled (refer to page 45).
- The system must be in the Run Mode.

EXAMPLE: A program name is TEST. The programmer generates a barcode with the name TEST embedded in the barcode. With the robot in the Run Mode, an operator scans the TEST barcode and the system matches the barcode to the program with the same name (in this case, TEST) and the robot begins executing the program.

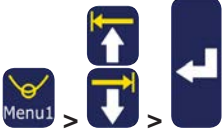
Setting Up Barcode Scanning (continued)

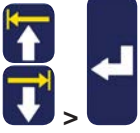
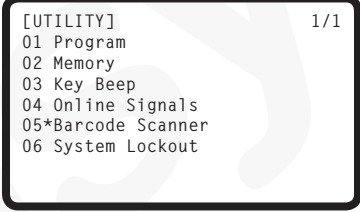
Enabling or Disabling Barcode Scanning (continued)

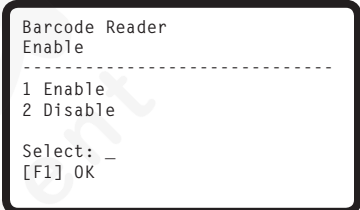
#	Key Press	Step	Teach Pendant Display
1		<ul style="list-style-type: none"> Press MENU1. MOVE UP / DOWN to UTILITY MENU. Press ENTER. 	
2		<ul style="list-style-type: none"> MOVE UP / DOWN to BARCODE SCANNER. Press ENTER. 	
3		<ul style="list-style-type: none"> Press 1 ENABLE to enable the barcode scanner. Press 2 DISABLE to Disable the barcode scanner. Press F1 to save or exit. 	

Setting the Dispenser Ports

There are two ways to modify the dispenser output ports; the correct method to use depends on the number of dispensers or valves in the system:

- For a system with a single dispenser / valve, change the Default Dispense Port setting. Refer to “Default Dispense Port (Dispense Port Output)” on page 39.
- For a system with multiple dispensers / valves, use the Dispense Port command. Refer to “15 Dispense Port” on page 104.

Programming

This section provides how-to procedures for the most commonly performed programming tasks. If you have difficulty creating a program for your application, contact your Nordson EFD representative.

Before using this section:

- Complete all applicable installation tasks. Refer to “Installation” on page 16.
- Complete setup tasks as applicable. Refer to “Setup” on page 34.



Refer to “Concepts” on page 20 and to “Overview of the Teach Pendant” on page 22 for important programming concepts and to learn how to use the Teach Pendant.

Working with Programs and Commands

This section focuses on how to manipulate the programs stored on the Teach Pendant. For information on how to create dispensing patterns, refer to “Creating Patterns” on page 62.

How to Switch from Run Mode to Teach Mode

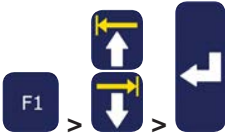
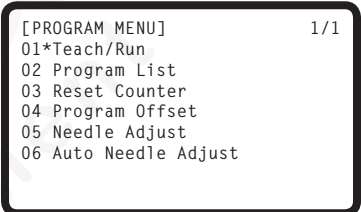
When the system is switched on, the default mode of operation is the Run Mode. To create programs, the system must be in the Teach Mode. Refer to “Run Mode vs. Teach Mode” on page 23 for more information on the modes of operation.

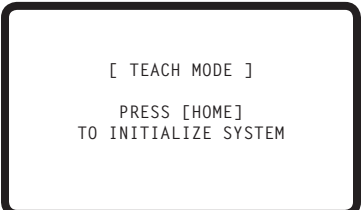
#	Key Press	Step	Teach Pendant Display
1		<ul style="list-style-type: none"> • Press F1. • MOVE UP / DOWN to TEACH/RUN. • Press ENTER. 	
2		<ul style="list-style-type: none"> • Press HOME. If prompted, enter a password. 	







Working with Programs and Commands (continued)

How to Open and Edit a Program

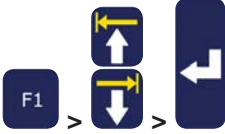
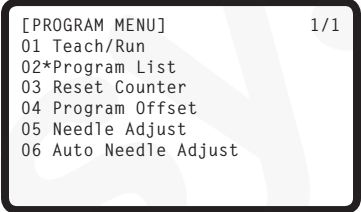
All programs have a unique number from 01 to 99. By default, the last program number that was open before the system was shut down is the same program number that opens when the system is switched on.

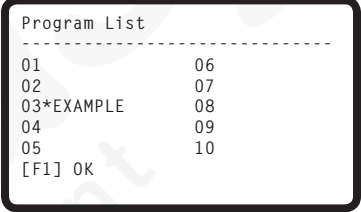
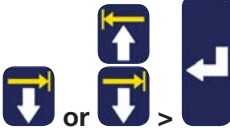
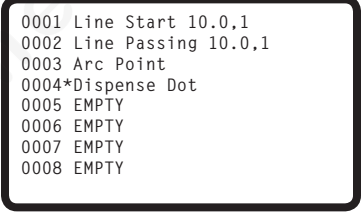
PREREQUISITES

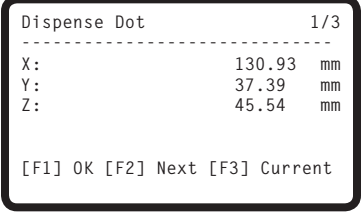
□ The system is in the Teach Mode. Refer to “How to Switch from Run Mode to Teach Mode” on page 46.

#	Key Press	Step	Teach Pendant Display
1		<ul style="list-style-type: none"> Press F1. MOVE UP / DOWN to PROGRAM LIST. Press ENTER. 	
2		<ul style="list-style-type: none"> MOVE UP / DOWN to select the desired program. Press ENTER. <p>The selected program becomes the current program and remains open until another program number is selected.</p>	
3		<ul style="list-style-type: none"> MOVE UP / DOWN to select the command line to edit. Press ENTER. 	
4		<ul style="list-style-type: none"> Enter the new coordinates manually. or Press F3 to update the XYZ values to the current tip location. Press F1 to save and exit or ESC to cancel the changes. 	
5		<ul style="list-style-type: none"> Make other changes as needed. Press F1 to save and exit. 	

Working with Programs and Commands (continued)

How to Name a Program

Nordson EFD recommends assigning a unique name to all programs. If a program is not named, the system prompts for a Program Name. Program names are limited to 15 characters. A program name is required for the barcode scanning capability.

PREREQUISITES

□ The system is in the Teach Mode. Refer to “How to Switch from Run Mode to Teach Mode” on page 46.

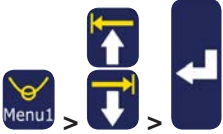
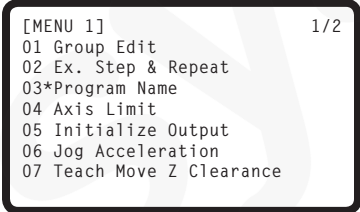
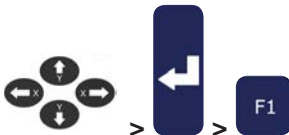
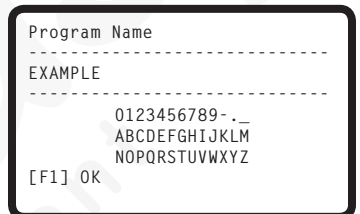
#	Key Press	Step	Teach Pendant Display
1		<ul style="list-style-type: none"> Press MENU1. MOVE UP / DOWN to PROGRAM NAME. Press ENTER. 	
2		<ul style="list-style-type: none"> Press the X jog buttons to move left / right and the Y jog buttons to move up / down through the characters. Press ENTER to select characters. Press CLEAR to delete characters. Press F1 to save and exit. 	







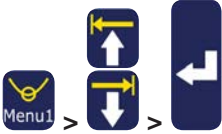

Working with Programs and Commands (continued)

How to Clear or Copy a Program

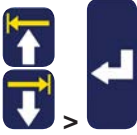
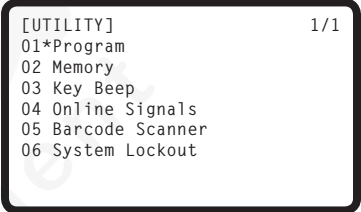
Program numbers 01 to 99 are either populated (program present) or empty (no program present). A currently open program can be cleared of its contents or the current program contents can be copied to a new program number. When program content is copied to a new program number, the content of the destination program is overwritten.

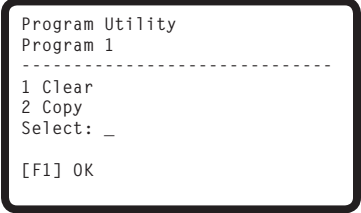
PREREQUISITES

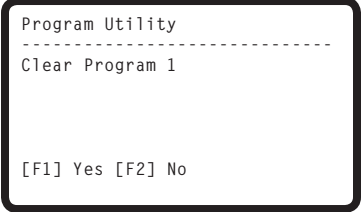
- ❑ The system is in the Teach Mode. Refer to “How to Switch from Run Mode to Teach Mode” on page 46.
- ❑ The program you want to clear or copy is currently open. Refer to “How to Open and Edit a Program” on page 47.

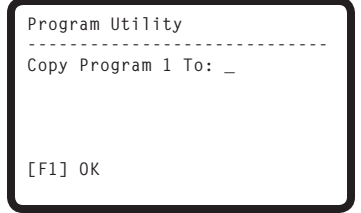



#	Key Press	Step	Teach Pendant Display
1		<ul style="list-style-type: none"> • Press MENU1. • MOVE UP / DOWN to UTILITY MENU. • Press ENTER. 	
2		<ul style="list-style-type: none"> • MOVE UP / DOWN to PROGRAM. • Press ENTER. 	
3		<ul style="list-style-type: none"> • Press 1 CLEAR to empty all addresses in the current program. • Press 2 COPY to copy the current program. • Press F1 to continue. 	
4		<ul style="list-style-type: none"> • If you pressed 1 (Clear), the system prompts for confirmation. • Press F1 to accept the clear or F2 to cancel the clear. 	
5		<ul style="list-style-type: none"> • If you pressed 2 (Copy), the system prompts for the program number to copy to (program number 1–99). • Press F1 to copy all program contents to the selected program number. <p>NOTE: If the destination program is not empty, the program contents are overwritten by the copied program.</p>	

Working with Programs and Commands (continued)

How to Jump to a Specific Address or Label

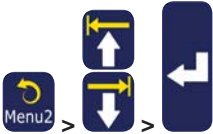
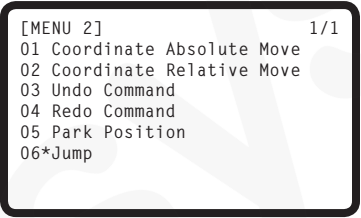
Use the Jump function to quickly move to a specific address line or label number within a dispense program.

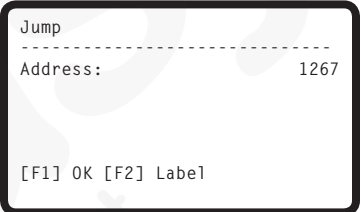

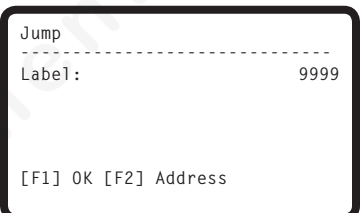
- ❑ The system is in the Teach Mode. Refer to “How to Switch from Run Mode to Teach Mode” on page 46.
- ❑ The program you want to edit is currently open. Refer to “How to Open and Edit a Program” on page 47.

#	Key Press	Step	Teach Pendant Display
1		<ul style="list-style-type: none"> • Press MENU 2. • MOVE UP / DOWN to JUMP. • Press ENTER. 	
2		<ul style="list-style-type: none"> • To jump to a specific address, use the number keys to enter the address, then press F1. • To jump to a Label, press F2. The Jump Label screen appears. 	
3		<ul style="list-style-type: none"> • To jump to a specific label, use the number keys to enter the label number, then press F1. • To return to the Jump to Address screen, press F2. 	

How to Insert or Delete a Command

PREREQUISITES

- ❑ The system is in the Teach Mode. Refer to “How to Switch from Run Mode to Teach Mode” on page 46.
- ❑ The program you want to edit is currently open. Refer to “How to Open and Edit a Program” on page 47.

Key Press	Function
	To insert a command, press INS. The command currently shown in the display increments by one address and a new, empty address is inserted at the current address.
	To delete a command, make sure it is shown in the Teach Pendant display, then press DEL > F1.



Working with Programs and Commands (continued)

How to Change a Group of Addresses (Group Edit)

You can use the selections under Group Edit to make a global change to a batch, or group, of selected addresses in a program.

PREREQUISITES

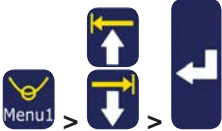
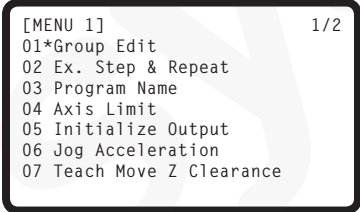
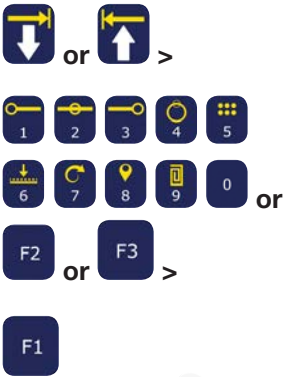
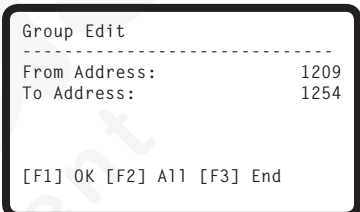

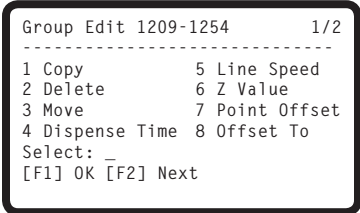
- ❑ The system is in the Teach Mode. Refer to “How to Switch from Run Mode to Teach Mode” on page 46.
- ❑ The program you want to edit is currently open. Refer to “How to Open and Edit a Program” on page 47.

#	Key Press	Step	Teach Pendant Display
1		<ul style="list-style-type: none"> • Press MENU1. • MOVE UP / DOWN to GROUP EDIT. • Press ENTER. 	
2		<p>Do one of the following:</p> <ul style="list-style-type: none"> • MOVE UP / DOWN and use the number keys to enter the range of addresses. • Press F2 to select all the addresses in the program. • Press F3 to select all the addresses from the current address to the end of the program. • Press F1 to continue. 	
3		<ul style="list-style-type: none"> • Press the number for the operation you want to perform for the specified range of addresses, or • Press F2 to move to the next screen. <ol style="list-style-type: none"> 1 – Copies the selected addresses 2 – Deletes the selected addresses 3 – Moves the selected addresses to a new address number 4 – For Dispense Dot commands only, changes the Dispense Time value for all selected addresses by the specified percentage. 5 – Changes the Line Speed value for all selected addresses by the specified percentage. 	

Continued on next page

Working with Programs and Commands (continued)

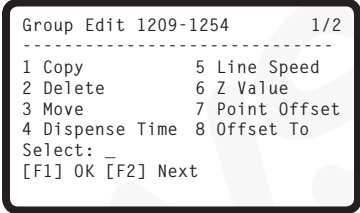
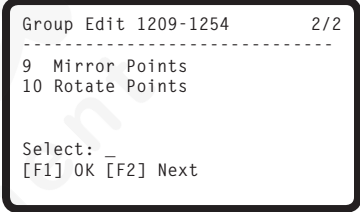
How to Change a Group of Addresses (Group Edit) (continued)

#	Key Press	Step	Teach Pendant Display
		<i>Step 3, continued from previous page</i>	
		6 – Changes the Z Value for all selected addresses to the absolute Z value.	 <pre> Group Edit 1209-1254 1/2 ----- 1 Copy 5 Line Speed 2 Delete 6 Z Value 3 Move 7 Point Offset 4 Dispense Time 8 Offset To Select: _ [F1] OK [F2] Next </pre>
		7 – Changes the XYZ values for all selected addresses by the specified offset value.	
		8 – Changes the XYZ values for all selected addresses by allowing you to jog the tip from its current location to a new location. The difference between the two locations determines the offset value.	
		9 – Changes the XYZ values for all selected addresses by flipping points along the X axis or the Y axis. Refer to “Example Illustrations of Mirror Points and Rotate Points” on page 53 for an example.	 <pre> Group Edit 1209-1254 2/2 ----- 9 Mirror Points 10 Rotate Points Select: _ [F1] OK [F2] Next </pre>
		10 –Rotates the tip the specified number of degrees ($\pm 180^\circ$) for all selected addresses. Before this occurs, the system prompts you to jog the tip to a starting point (or rotation origin). Refer to “Example Illustrations of Mirror Points and Rotate Points” on page 53 for an example.	
4		<ul style="list-style-type: none"> Press F1 to continue and follow the instructions on the display to complete the selected action for the specified range of addresses. 	
5		<ul style="list-style-type: none"> When done, press F1 again to save or exit. 	

Working with Programs and Commands (continued)

How to Change a Group of Addresses (Group Edit) (continued)

Example Illustrations of Mirror Points and Rotate Points

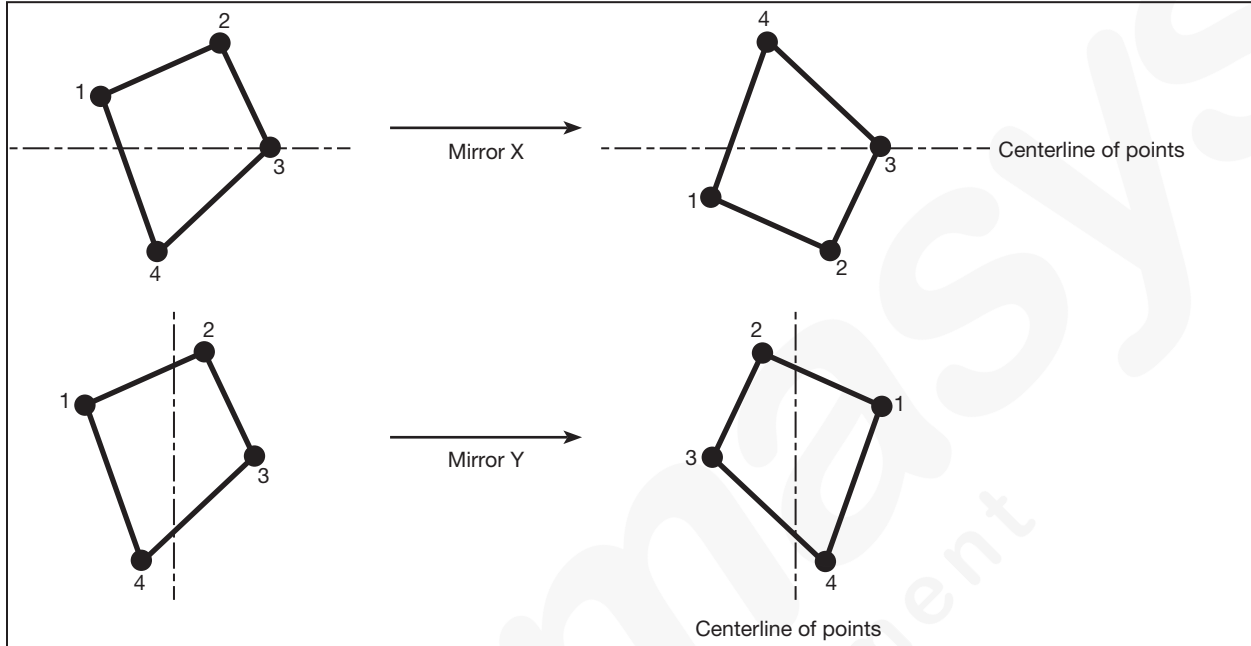

Example illustration of Mirror Points under Group Edit

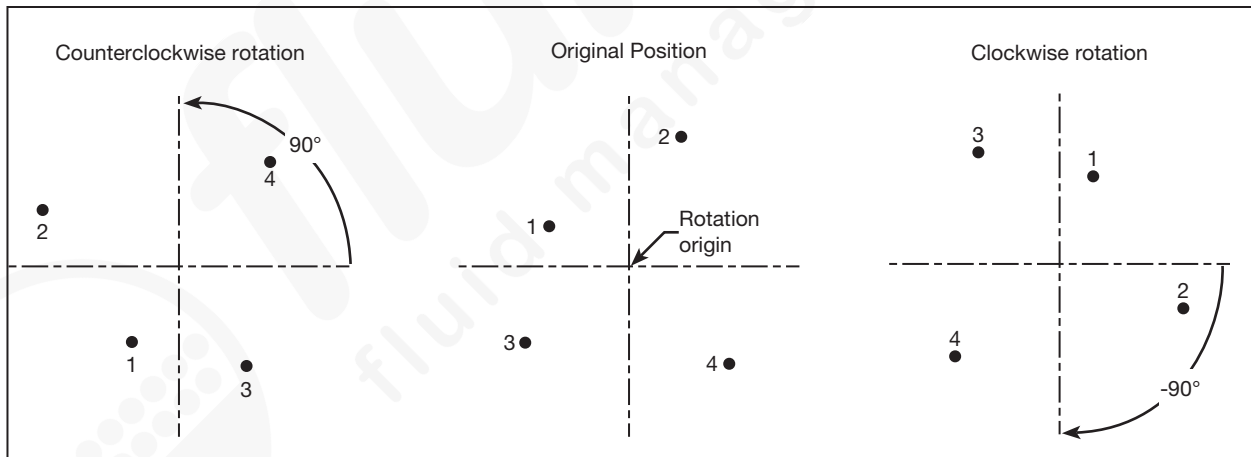

Example illustration of Rotate Points under Group Edit



Working with Programs and Commands (continued)

How to Set Mark Points

If the location and / or orientation of a workpiece changes, the system can automatically adjust all the XY values in a program to the new location or orientation. This is done using the Program Offset function. For this function to work properly, follow this procedure to set two Mark Points on the workpiece.

PREREQUISITES

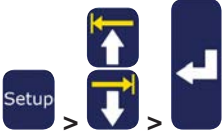
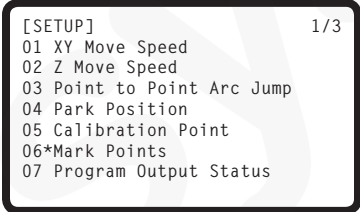
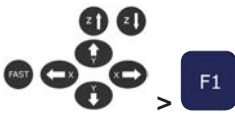
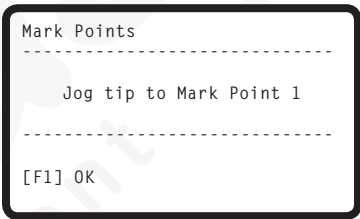
□ A workpiece is properly positioned on the fixture plate.

#	Key Press	Step	Teach Pendant Display
1		<ul style="list-style-type: none"> Press SETUP. MOVE UP / DOWN to MARK POINTS. Press ENTER. 	
2		<ul style="list-style-type: none"> Jog the tip to the first mark point and lower the tip until it is as close to the mark point as possible. Press F1 to save the setting. 	
3		<ul style="list-style-type: none"> Jog the tip to the second mark point and lower the tip until it is as close to the mark point as possible. Press F1 to save the setting. <p>The system saves the mark points. Now, if you need to change the position and / or orientation of a workpiece, you can use Program Offset (refer to page 55) to update all the XY locations in the program to the new workpiece location and / or orientation.</p>	

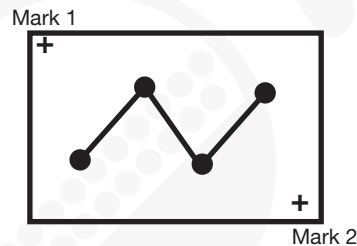

Example of two Mark Point locations on a workpiece



Working with Programs and Commands (continued)

How to Adjust All Points in a Program (Program Offset)

Use Program Offset to update all the points in a program when the position (location or orientation) of a workpiece has changed. For this function to work properly, you must set two Mark Points.

PREREQUISITES

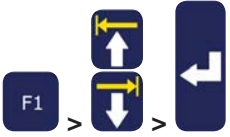
- ❑ The system is in the Teach Mode. Refer to “How to Switch from Run Mode to Teach Mode” on page 46.
- ❑ The program to be updated was correct and working properly before the workpiece position changed.

#	Key Press	Step	Teach Pendant Display
1		<ul style="list-style-type: none"> • Set Mark Points for the workpiece. Refer to “How to Set Mark Points” on page 54. 	
2		<ul style="list-style-type: none"> • Press F1. • MOVE UP / DOWN to PROGRAM OFFSET. • Press ENTER. 	<div style="border: 1px solid black; padding: 5px;"> <pre>[PROGRAM MENU] 1/1 01 Teach/Run 02 Program List 03 Reset Counter 04*Program Offset 05 Needle Adjust 06 Auto Needle Adjust</pre> </div>
3		<ul style="list-style-type: none"> • Press ENTER to begin. Follow the instructions shown on the display. <p>When complete, the system automatically adjusts all the points in the current program for the new workpiece position.</p>	<div style="border: 1px solid black; padding: 5px;"> <pre>Program Offset ----- Press [ENTER] to begin -----</pre> </div>

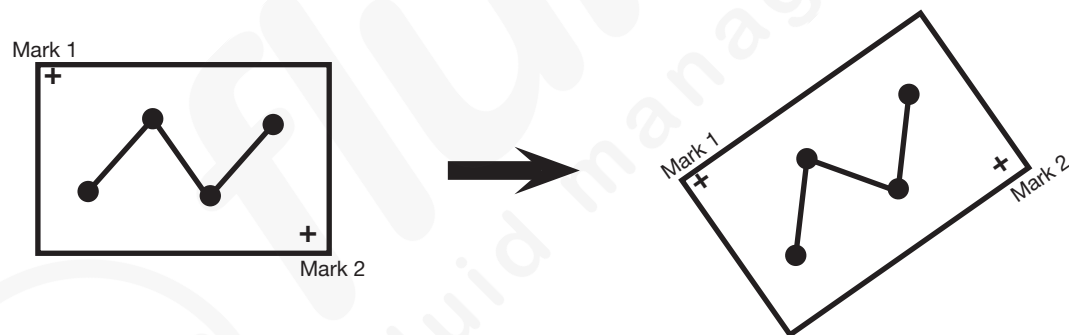

Example illustration of Program Offset

Working with Programs and Commands (continued)

How to Expand a Step & Repeat Command

Use this function to expand an existing Step & Repeat command to show all the addresses contained in the command. The Ex. Step & Repeat command is useful for editing individual dispense commands.

NOTES:

- The Ex. Step & Repeat command can be reversed using Undo Command under Menu2.
- An expanded Step & Repeat command requires more addresses than an unexpanded Step & Repeat command.

PREREQUISITES

- ❑ The system is in the Teach Mode. Refer to “How to Switch from Run Mode to Teach Mode” on page 46.
- ❑ The program you want to edit is currently open. Refer to “How to Open and Edit a Program” on page 47.
- ❑ The Step & Repeat command you want to expand is selected. Refer to “How to Make an Array of Dots (Step & Repeat)” on page 70 for details on the Step & Repeat command.

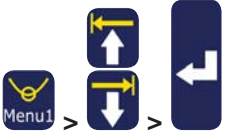
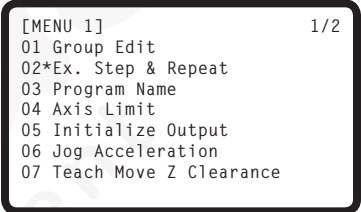
#	Key Press	Step	Teach Pendant Display
1		<ul style="list-style-type: none"> • Press MENU1. • MOVE UP / DOWN to EX. STEP & REPEAT. • Press ENTER. <p>The selected Step & Repeat command is expanded to the root level of the program and all addresses are renumbered accordingly.</p>	

Working with Programs and Commands (continued)







How to Lock or Unlock the System

Use System Lockout under the Utility menu to prohibit unauthorized access to dispense programs.

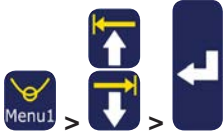
PREREQUISITES

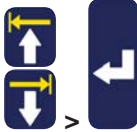
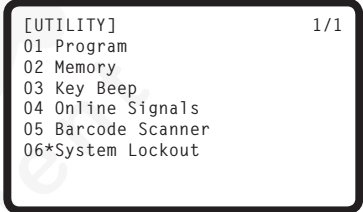

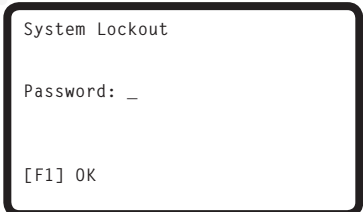

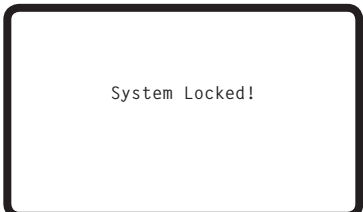
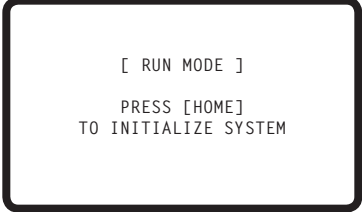

- ❑ The system is in the Teach Mode. Refer to “How to Switch from Run Mode to Teach Mode” on page 46.
- ❑ A system password has been set (the default is blank). Refer to “Password Setup” on page 40.

To Lock the System

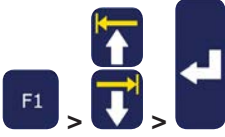
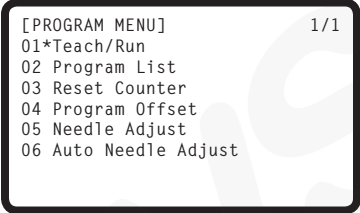
#	Key Press	Step	Teach Pendant Display
1		<ul style="list-style-type: none"> • Press MENU1. • MOVE UP / DOWN to UTILITY MENU. • Press ENTER. 	
2		<ul style="list-style-type: none"> • MOVE UP / DOWN to SYSTEM LOCKOUT. • Press ENTER. 	
3		<ul style="list-style-type: none"> • Enter the password. • Press F1. 	
4		<p>The system is now locked and automatically switches to the Run Mode.</p> <ul style="list-style-type: none"> • Press HOME to continue. <p>NOTE: When the system is locked, the Teach Pendant prompts for a password every time you want to switch from the Run Mode to the Teach Mode. To disable the system lockout, continue to the next section.</p>	 

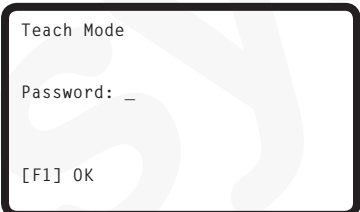
Working with Programs and Commands (continued)

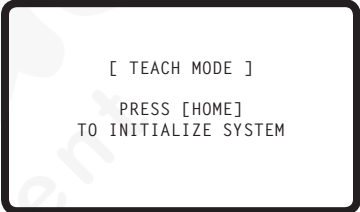
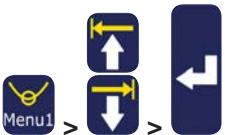
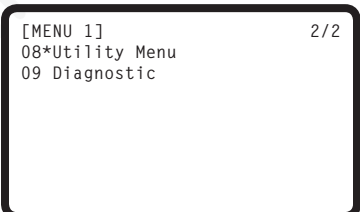
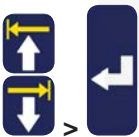
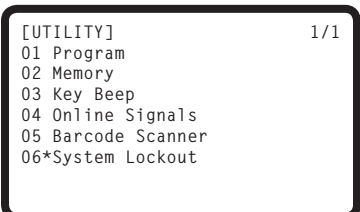
To Unlock the System

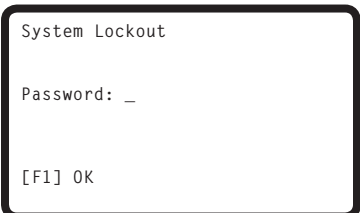
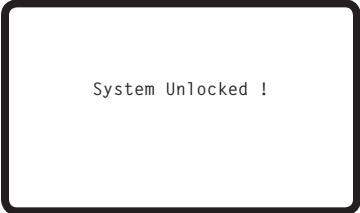
#	Key Press	Step	Teach Pendant Display
1		<ul style="list-style-type: none"> Press F1. MOVE UP / DOWN to TEACH/RUN. Press ENTER. 	
2		<ul style="list-style-type: none"> Enter the password. Press F1. 	
3		<ul style="list-style-type: none"> Press HOME. 	
4		<ul style="list-style-type: none"> Press MENU1. MOVE UP / DOWN to UTILITY MENU. Press ENTER. 	
5		<ul style="list-style-type: none"> MOVE UP / DOWN to SYSTEM LOCKOUT. Press ENTER. 	
6		<ul style="list-style-type: none"> Enter the password. Press F1. <p>The system no longer requires a password to switch from Run Mode to Teach Mode.</p>	 



Working with Programs and Commands (continued)

How to Upload / Download Programs Using the SVC USB Port

You can use the SVC USB port on the front of the robot to upload or download programs to or from the robot.

PREREQUISITES

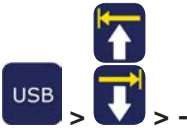
□ The system is in the Teach Mode. Refer to “How to Switch from Run Mode to Teach Mode” on page 46.

#	Key Press	Step	Teach Pendant Display
1		<ul style="list-style-type: none"> • Switch OFF the robot. • Connect the USB drive to the SVC USB port on the front of the robot. • Switch ON the robot. 	
			
2		<ul style="list-style-type: none"> • Press USB. The USB menu appears. <ul style="list-style-type: none"> - Select 1 to load a *.NDN program selected from the USB drive to the specified program number on the robot. - Select 2 to save the current program to the USB drive as a *.NDN file. - Select 3 to load a *.PKG file from the USB drive. Loading this file may overwrite existing programs located in populated program numbers. - Select 4 to save all populated robot programs to the USB drive as a *.PKG file. • Follow the instructions on the display to complete the selected action. 	



Working with Programs and Commands (continued)

How to Create and Run a Program

The procedure provides the basic steps for creating and running a program. Every program is different. Use these steps and the other applicable sections of this manual to create a program.

PREREQUISITES

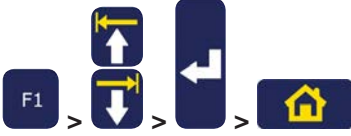
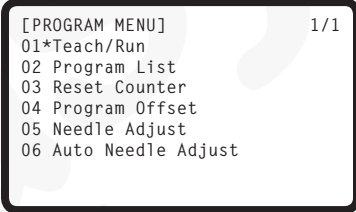
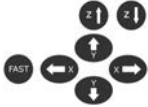

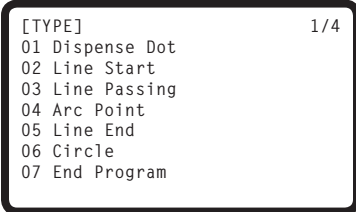





- ❑ The system is properly installed and set up. Refer to “Installation” on page 16 and “Setup” on page 34.
- ❑ The Teach Pendant cable is connected to the robot and the system is in the Teach Mode. Refer to “How to Switch from Run Mode to Teach Mode” on page 46.
- ❑ (Recommended) The tip height is calibrated; if the tip was changed, perform a Needle Adjust (systems without a tip aligner) or Auto Needle Adjust (systems with a tip aligner). Refer to “Calibrating the Tip Height” on page 72.
- ❑ The workpiece is properly positioned on the fixture plate.

#	Key Press	Step	Teach Pendant Display
1		<ul style="list-style-type: none"> • Press F1. • MOVE UP / DOWN to TEACH/RUN. • Press ENTER. • Press HOME. If prompted, enter a password. <p>The system opens the last program number that was modified prior to shutdown.</p>	
2		<ul style="list-style-type: none"> • Jog the tip to the first point in a pattern. 	
3		<ul style="list-style-type: none"> • When the tip is at the correct XYZ location for the first point, press TYPE to select a dispense command for the point. • Refer to the following sections of this manual for information on creating programs: <ul style="list-style-type: none"> - “Best Practices for Programming” on page 21. - “Creating Patterns” on page 62. - “Appendix A, Type Menu Reference” on page 91 for detailed information on all commands. <p>NOTE: You can also press the ENTER key in empty address lines to open the Type menu.</p>	
4		<ul style="list-style-type: none"> • Continue entering commands until the program is complete. 	

Continued on next page

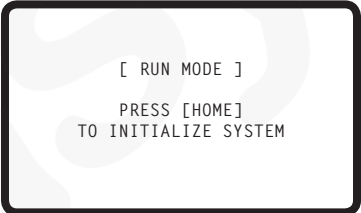
Working with Programs and Commands (continued)

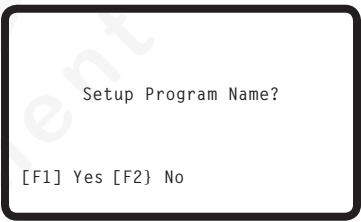
How to Create and Run a Program (continued)

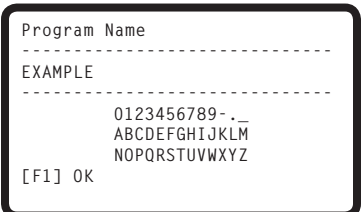
#	Key Press	Step	Teach Pendant Display
5	 > 	<ul style="list-style-type: none"> Press SHIFT > END to register the last address as the end of the program. 	
6		<ul style="list-style-type: none"> Press START on the Teach Pendant to run the program in the Teach Mode. 	
7		<ul style="list-style-type: none"> Make adjustments in the program until the desired result is achieved. 	
8	 > 	<ul style="list-style-type: none"> When complete, press F1 > HOME to switch the system to the Run Mode. 	
9	 or 	<p>If the program was not named using MENU1 > PROGRAM NAME, the system prompts for a program name:</p> <ul style="list-style-type: none"> Press F1 to name the program (recommended). Press F2 to continue without naming the program. <p>NOTE: To switch programs, refer to “How to Open and Edit a Program” on page 47.</p>	
10	 > 	<ul style="list-style-type: none"> If you pressed F1, use the jog keys and the ENTER key to enter a program name. Press F1 to save and continue. 	

Creating Patterns

This section provides quick-reference procedures for creating the most commonly used dispensing patterns. Use the procedures in this section in tandem with “Appendix A, Type Menu Reference” on page 91, which provides detailed information on commands.

For basic procedures on how to create a program and how to manipulate programs (such as opening programs or copying, inserting, and deleting commands), refer to “Working with Programs and Commands” on page 46.

About Navigating the Type Menu

- Press the MOVE UP, MOVE DOWN, ENTER, and numeric keys to move through and change XYZ values.
- Press F1 (OK) to save displayed values and exit the menu.
- Press F2 (Next) to accept displayed values and move to the next screen.
- Press F3 (Current) to change displayed coordinates to the current tip location.
- Press ESC to cancel any changes to return to the program.

How to Make a Dot



PREREQUISITES

□ The system is in the Teach Mode. Refer to “How to Switch from Run Mode to Teach Mode” on page 46.

#	Key Press	Step	Teach Pendant Display
1		<ul style="list-style-type: none"> • Jog the dispensing tip to the desired XYZ location for the dispense dot. 	
2		<ul style="list-style-type: none"> • Press SHIFT > TYPE to open the Dispense Dot screen. • Make XYZ coordinate changes as needed. 	
3		<ul style="list-style-type: none"> • Press F2 to move through the Dispense Dot parameter screens. • Press F1 to save and exit. 	
4		<ul style="list-style-type: none"> • Press SHIFT > END to register the end of the program. 	
5		<ul style="list-style-type: none"> • Press START to run the program. 	

Creating Patterns (continued)

How to Make a Line

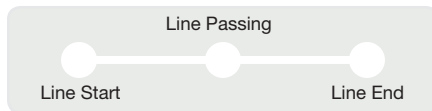

PREREQUISITES







□ The system is in the Teach Mode. Refer to “How to Switch from Run Mode to Teach Mode” on page 46.

#	Key Press	Step	Teach Pendant Display
1		<ul style="list-style-type: none"> Jog the dispensing tip to an XYZ location for the first dispense point (Line Start). 	
2		<ul style="list-style-type: none"> Press SHIFT > 1 to register the location as a Line Start point. Make XYZ coordinate changes as needed. 	<pre>Line Start 1/2 ----- X: 130.93 mm Y: 37.39 mm Z: 45.54 mm [F1] OK [F2] Next [F3] Current</pre>
3		<ul style="list-style-type: none"> Press F2 to move to the Line Start parameter screen. Press F1 to save and exit. 	<pre>Line Start 2/2 ----- Line Speed: 10.0 mm/s Pre-move Delay: 0.00 s Settling Distance: 0.00 mm Dispenser Off(0)/On(1): 1 [F1] OK [F2] Next</pre>
4		<ul style="list-style-type: none"> Jog the tip to the XYZ location of the second point (Line Passing). 	
5		<ul style="list-style-type: none"> Press SHIFT > 2 to register the location as a Line Passing point. Make XYZ coordinate changes as needed. 	<pre>Line Passing 1/2 ----- X: 130.93 mm Y: 37.39 mm Z: 45.54 mm [F1] OK [F2] Next [F3] Current</pre>
6		<ul style="list-style-type: none"> Press F2 to move to the Line Passing parameter screen. Press F1 to save and exit. 	<pre>Line Passing 2/2 ----- Line Speed: 10.0 mm/s Node Time: 0.00 s Dispenser Off(0)/On(1): 1 [F1] OK [F2] Next</pre>

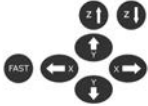
Continued on next page

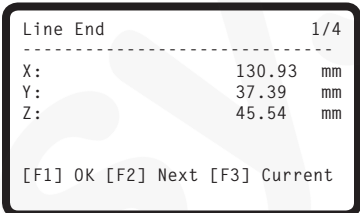
Creating Patterns (continued)

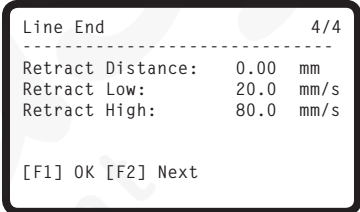
How to Make a Line (continued)

#	Key Press	Step	Teach Pendant Display
7		<ul style="list-style-type: none"> Jog the tip to the XYZ location of for the last dispense point (Line End). 	
8		<ul style="list-style-type: none"> Press SHIFT > 3 to register the location as a Line End point. Make XYZ coordinate changes as needed. 	
9		<ul style="list-style-type: none"> Press F2 to move through the Line End parameter screens. Press F1 to save and exit. 	
10		<ul style="list-style-type: none"> Press SHIFT > END to register the end of the program. 	
11		<ul style="list-style-type: none"> Press START to run the program. 	

Creating Patterns (continued)

How to Make an Arc

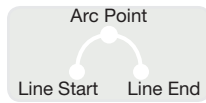

PREREQUISITES







□ The system is in the Teach Mode. Refer to “How to Switch from Run Mode to Teach Mode” on page 46.

#	Key Press	Step	Teach Pendant Display
1		<ul style="list-style-type: none"> Jog the dispensing tip to an XYZ location for the first dispense point (Line Start). 	
2		<ul style="list-style-type: none"> Press SHIFT > 1 to register the location as a Line Start point. Make XYZ coordinate changes as needed. 	<pre>Line Start 1/2 ----- X: 130.93 mm Y: 37.39 mm Z: 45.54 mm [F1] OK [F2] Next [F3] Current</pre>
3		<ul style="list-style-type: none"> Press F2 to move to the Line Start parameter screen. Press F1 to save and exit. 	<pre>Line Start 2/2 ----- Line Speed: 10.0 mm/s Pre-move Delay: 0.00 s Settling Distance: 0.00 mm Dispenser Off(0)/On(1): 1 [F1] OK [F2] Next</pre>
4		<ul style="list-style-type: none"> Jog the tip to the XYZ location of where the top of the arc should be (Arc Point). 	
5		<ul style="list-style-type: none"> Press SHIFT > MENU1 to register the location as an Arc Point. Make XYZ coordinate changes as needed. Press F1 to save and exit. 	<pre>Arc Point ----- X: 130.93 mm Y: 37.39 mm Z: 45.54 mm [F1] OK [F3] Current</pre>
6		<ul style="list-style-type: none"> Jog the tip to the XYZ location where the arc should end (Line End). 	

Continued on next page

Creating Patterns (continued)

How to Make an Arc (continued)

#	Key Press	Step	Teach Pendant Display
7	 > 	<ul style="list-style-type: none"> Press SHIFT > 3 to register the location as a Line End point. Make XYZ coordinate changes as needed. 	<pre> Line End 1/4 ----- X: 130.93 mm Y: 37.39 mm Z: 45.54 mm [F1] OK [F2] Next [F3] Current </pre>
8	 > 	<ul style="list-style-type: none"> Press F2 to move through the Line End parameter screens. Press F1 to save and exit. 	<pre> Line End 4/4 ----- Retract Distance: 0.00 mm Retract Low: 20.0 mm/s Retract High: 80.0 mm/s [F1] OK [F2] Next </pre>
9	 > 	<ul style="list-style-type: none"> Press SHIFT > END to register the end of the program. 	
10		<ul style="list-style-type: none"> Press START to run the program. 	











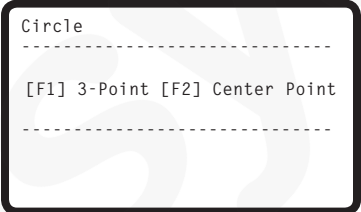

Creating Patterns (continued)

How to Make a Circle

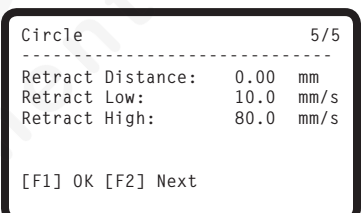

PREREQUISITES

□ The system is in the Teach Mode. Refer to “How to Switch from Run Mode to Teach Mode” on page 46.

#	Key Press	Step	Teach Pendant Display
1	 >  >  or 	<ul style="list-style-type: none"> Press SHIFT > 4 to open the Circle menu. Press F1 to make a circle by selecting three points on the diameter of the circle. Press F2 to make a circle by entering the center point of the circle. 	
2		<ul style="list-style-type: none"> Follow the directions on the display to enter the XYZ coordinates. 	
3	 > 	<ul style="list-style-type: none"> Press F2 to move through the Circle parameter screens. Press F1 to save and exit. 	
4	 > 	<ul style="list-style-type: none"> Press SHIFT > END to register the end of the program. 	
5		<ul style="list-style-type: none"> Press START to run the program. 	











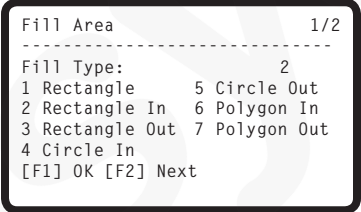

Creating Patterns (continued)

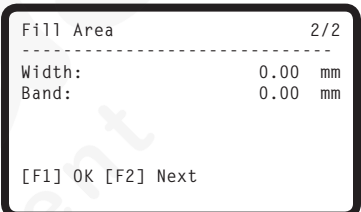
How to Fill an Area

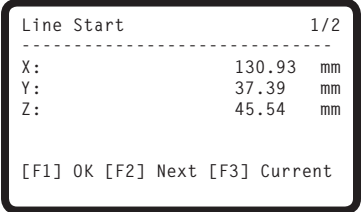

PREREQUISITES

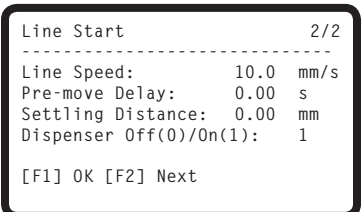







□ The system is in the Teach Mode. Refer to “How to Switch from Run Mode to Teach Mode” on page 46.

#	Key Press	Step	Teach Pendant Display
1	 >  > 	<ul style="list-style-type: none"> Press SHIFT > 9 to open the Fill Area menu, then select the Fill Type. Press 1 RECTANGLE. <p>NOTE: This procedure shows how to fill a rectangle. Refer to “22 Fill Area” on page 108 for detailed information on each of the fill types.</p>	
2	 > xx.xx > 	<ul style="list-style-type: none"> Press F2 to move to the Fill Area parameter screen. Enter the Width and Band settings for the area to be filled, then press F1 to save the setting and return to the program. 	
3		<ul style="list-style-type: none"> Jog the dispensing tip to the top left corner of the area to be filled. 	
4	 > 	<ul style="list-style-type: none"> Press SHIFT > 1 to register the location as a Line Start point. 	
5	 > 	<ul style="list-style-type: none"> Press F2 to move to the Line Start parameter screen. Press F1 to save and exit. 	
6		<ul style="list-style-type: none"> Jog the dispensing tip to the bottom right corner of the area to be filled. 	

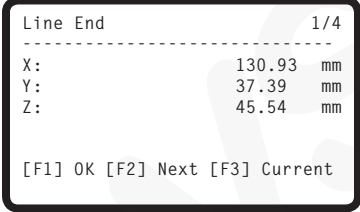
Continued on next page

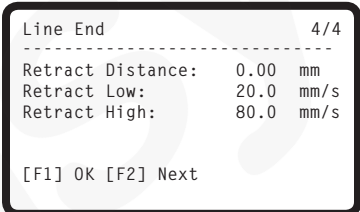
Creating Patterns (continued)

How to Fill an Area (continued)

#	Key Press	Step	Teach Pendant Display
7	 > 	<ul style="list-style-type: none"> Press SHIFT > 3 to register the location as a Line End point. 	
8	 > 	<ul style="list-style-type: none"> Press F2 to move through the Line End parameter screens. Press F1 to save and exit. 	
9	 > 	<ul style="list-style-type: none"> Press SHIFT > END to register the end of the program. 	
10		<ul style="list-style-type: none"> Press START to run the program. 	

Creating Patterns (continued)

How to Make an Array of Dots (Step & Repeat)

Use Step & Repeat to dispense the same pattern on multiple workpieces in an array.

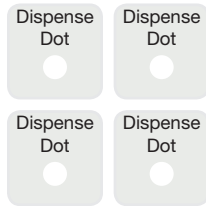

PREREQUISITES







- ❑ The system is in the Teach Mode. Refer to “How to Switch from Run Mode to Teach Mode” on page 46.
- ❑ Multiple workpieces are properly positioned on the fixture plate. Refer to “12 Step & Repeat 2D” on page 100 and to “12 Step & Repeat 3D” on page 102 for detailed information on this command.

#	Key Press	Step	Teach Pendant Display
1		<ul style="list-style-type: none"> • Press SHIFT > 8 to open the Label screen. • Enter a Label number (in this example, the number 2). • Press F1 to save and exit. 	
2		<ul style="list-style-type: none"> • Jog the dispensing tip to the desired XYZ location for the first dispense dot. 	
3		<ul style="list-style-type: none"> • Press SHIFT > TYPE to open the Dispense Dot screen. • Make XYZ coordinate changes as needed. 	
4		<ul style="list-style-type: none"> • Press F2 to move through the Dispense Dot parameter screens. • Press F1 to save and exit. 	
5		<ul style="list-style-type: none"> • Press SHIFT > 5 to open the Step & Repeat menu. • Press F1. 	

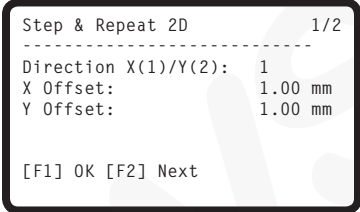
Continued on next page

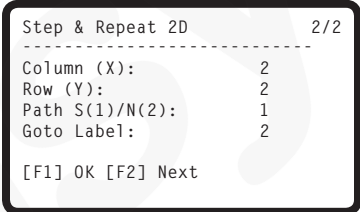
Creating Patterns (continued)

How to Make an Array of Dots (Step & Repeat) (continued)

#	Key Press	Step	Teach Pendant Display
6		<ul style="list-style-type: none"> Press F2 to move to the next screen. 	
7	 > 	<ul style="list-style-type: none"> Enter 2 in the Column field. Enter 2 in the Row field. Enter the label number from step 1 for Goto Label (in this example, 2). Press F1 to save and exit. 	
8	 > 	<ul style="list-style-type: none"> Press SHIFT > END to register the end of the program. 	
9		<ul style="list-style-type: none"> Press START to test the program. 	

Calibrating the Tip Height

Tip height is the distance from the tip to the fixture plate surface. The tip height must be calibrated and then recalibrated as needed to compensate for slight variations in height that occur when changes are made to the system, primarily nozzle or tip change-out.

NOTE: For information on when to calibrate the tip height, to “About Tip Height” on page 21.

Systems without a Tip Aligner

If your system does not include the optional tip aligner, follow these procedures to calibrate the tip height and then to manually recalibrate the tip height after a same-to-same dispensing tip change.

NOTE: The optional tip aligner can be added to an existing system. Refer to “Tip Aligner” on page 81.

Set a Calibration Point (Initial Setup for Needle Adjust)

The system uses a calibration point for the Needle Adjust function to recalibrate the tip height after a same-to-same dispensing tip change.

PREREQUISITES

□ The system is in the Teach Mode. Refer to “How to Switch from Run Mode to Teach Mode” on page 46.

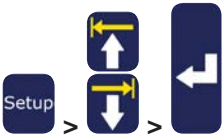
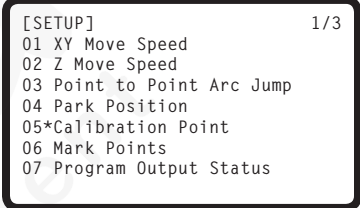
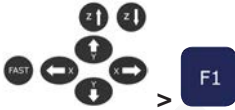
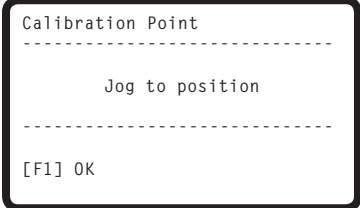

#	Key Press	Step	Teach Pendant Display
1		<ul style="list-style-type: none"> Press SETUP. MOVE UP / DOWN to CALIBRATION POINT. Press ENTER. 	
2		<ul style="list-style-type: none"> Jog the tip down until it is as close to the fixture plate surface as possible. Press F1 to save the setting. 	

Calibrating the Tip Height (continued)

Recalibrate the Tip (Needle Adjust)

PREREQUISITES

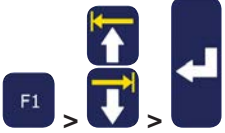
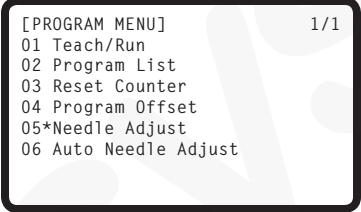
□ The tip height is calibrated. Refer to “Set a Calibration Point (Initial Setup for Needle Adjust)” on page 72.

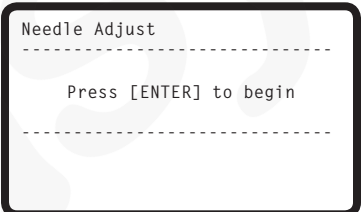
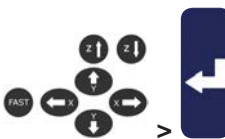
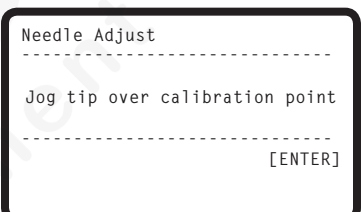
#	Key Press	Step	Teach Pendant Display
1		<ul style="list-style-type: none"> • Press F1. • MOVE UP / DOWN to NEEDLE ADJUST. • Press ENTER. 	
2		<ul style="list-style-type: none"> • Press ENTER. <p>The dispensing tip moves to the user-defined calibration point.</p> <p>NOTE: The tip will be 5 mm (0.2") higher than the calibrated point to prevent possible crushing of the tip.</p>	
3		<ul style="list-style-type: none"> • Jog the tip until it is centered over the calibration point. • Press ENTER. <p>The system adjusts the dispense program to the recalibrated tip height.</p>	

Calibrating the Tip Height (continued)

Systems with a Tip Aligner







If your system includes the optional tip aligner, follow these procedures to calibrate the tip height and to automatically recalibrate the tip height after a same-to-same dispensing tip change.

Set a Calibration Point (Initial Setup for Auto Needle Adjust)

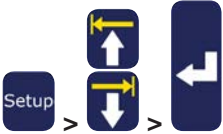
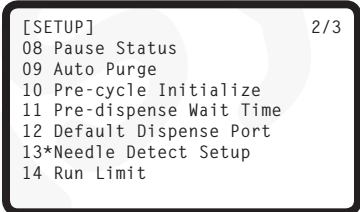
The system uses Needle Detect Setup for the Automatic Needle Adjust function to recalibrate the tip height after a same-to-same dispensing tip change.

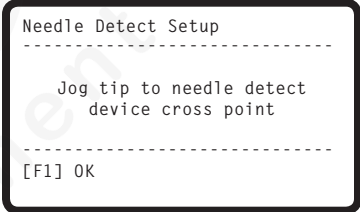
PREREQUISITES

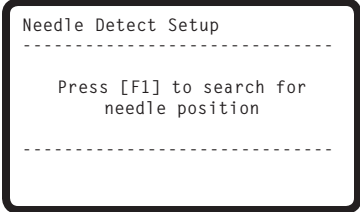
□ The system is in the Teach Mode. Refer to “How to Switch from Run Mode to Teach Mode” on page 46.

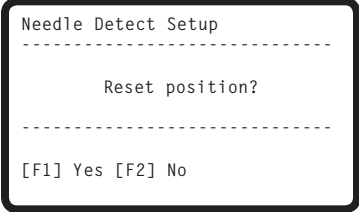



#	Key Press	Step	Teach Pendant Display
1		<ul style="list-style-type: none"> Press SETUP. MOVE UP / DOWN to NEEDLE DETECT SETUP. Press ENTER. 	
2		<ul style="list-style-type: none"> Jog the tip to the tip aligner and lower the tip until it is as close to the crosshairs (cross point) as possible. Press F1. <p>The Needle Detect Setup screen appears.</p>	
3		<ul style="list-style-type: none"> Press F1. <p>The system begins the calibration.</p>	
4		<ul style="list-style-type: none"> Press F1 to accept the calibration. <p>NOTE: Press F2 to cancel the calibration.</p>	

Calibrating the Tip Height (continued)

Recalibrate the Tip (Auto Needle Adjust)

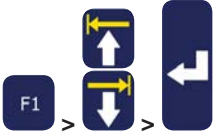
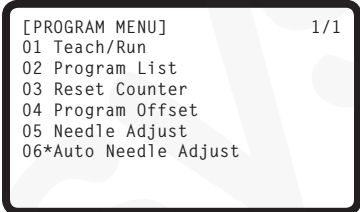
PREREQUISITES

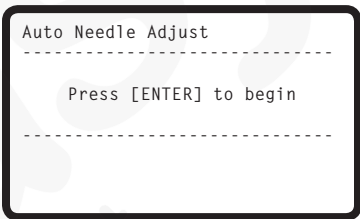
□ The needle detect position is calibrated. Refer to “Set a Calibration Point (Initial Setup for Auto Needle Adjust)” on page 74.

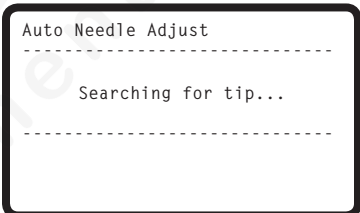
#	Key Press	Step	Teach Pendant Display
1		<ul style="list-style-type: none"> Press F1. MOVE UP / DOWN to AUTO NEEDLE ADJUST. Press ENTER. 	
2		<ul style="list-style-type: none"> Press ENTER. <p>The system automatically checks the tip height using the tip aligner and displays the offset updates needed to calibrate the tip height.</p>	
3		<ul style="list-style-type: none"> After the search is complete, press F1 to accept the calibration. 	

Working with Inputs / Outputs

If you connected inputs/outputs, refer to these procedures as applicable to use the inputs / outputs. There are several ways to use inputs / outputs:

- As a program command (SET I/O) to enable or disable outputs in a program.
- As a setting change under INITIALIZE OUTPUT.
- As a setting change under PROGRAM OUTPUT STATUS.

NOTE: The last two bullets apply if you want the system to automatically change the behavior of an output.

Enable or Disable an Input / Output

Inputs / outputs can be switched on or off within a program using the SET I/O command. SET I/O is also used to make the system check the status of an input signal at a specific point in the program.

PREREQUISITES

- ❑ The system is in the Teach Mode. Refer to “How to Switch from Run Mode to Teach Mode” on page 46.
- ❑ The program you want to edit is currently open. Refer to “How to Open and Edit a Program” on page 47.
- ❑ Input / output wiring is properly connected. Refer to “I/O Port” on page 89 for wiring diagrams.

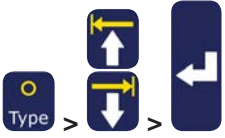
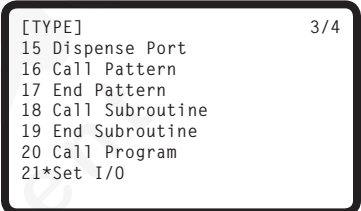
#	Key Press	Step	Teach Pendant Display
1		<ul style="list-style-type: none"> • Press TYPE. • MOVE UP / DOWN to SET I/O. • Press ENTER. <p>The Set I/O menu appears. Refer to “21 Set I/O” on page 107 for detailed information on the Set I/O command.</p>	 <pre>[TYPE] 3/4 15 Dispense Port 16 Call Pattern 17 End Pattern 18 Call Subroutine 19 End Subroutine 20 Call Program 21*Set I/O</pre>



Automatically Switch Outputs ON

Use Initialize Output under Menu1 to specify which outputs (1–8) switch ON at the beginning of programs.

NOTE: Online signals must be disabled.

PREREQUISITES

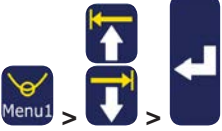
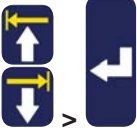
□ The system is in the Teach Mode. Refer to “How to Switch from Run Mode to Teach Mode” on page 46.



#	Key Press	Step	Teach Pendant Display
1		<ul style="list-style-type: none"> Press MENU1. MOVE UP / DOWN to INITIALIZE OUTPUT Press ENTER. 	<pre>[MENU 1] 01 Group Edit 02 Ex. Step & Repeat 03 Program Name 04 Axis Limit 05*Initialize Output 06 Jog Acceleration 07 Teach Move Z Clearance</pre>
2		<ul style="list-style-type: none"> Use the ARROW keys to move through the outputs. Press ENTER to toggle values: 1 for ON, 0 for OFF. 	<pre>Initialize Output ----- Port: 12345678 Current: 00000000 New: 00000000 [F1] OK</pre>
3		<ul style="list-style-type: none"> Press F1 to save or exit. 	

Set How Outputs Behave at the End of a Program

Use Program Output Status under Setup to specify how outputs function after programs end.

PREREQUISITES

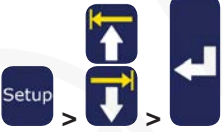
□ The system is in the Teach Mode. Refer to “How to Switch from Run Mode to Teach Mode” on page 46.

#	Key Press	Step	Teach Pendant Display
1		<ul style="list-style-type: none"> Press SETUP. MOVE UP / DOWN to PROGRAM OUTPUT STATUS. Press ENTER. 	<pre>[SETUP] 1/3 01 XY Move Speed 02 Z Move Speed 03 Point to Point Arc Jump 04 Park Position 05 Calibration Point 06 Mark Points 07*Program Output Status</pre>
2		<ul style="list-style-type: none"> Press 1 ENABLE to keep outputs ON after a program ends. Press 2 DISABLE (default) to allow outputs to switch OFF after a program ends. 	<pre>Program Output Status Disable ----- 1 Enable 2 Disable Select: _ [F1] OK</pre>
3		<ul style="list-style-type: none"> Press F1 to save or exit. 	

Operation

After the system is installed and programmed, the only actions required from the operator are to switch on the system, run the program for the workpiece, and shut down the system at the end of the work period.

Starting the System for Routine Operation

1. Connect the Teach Pendant to the Teach Pendant port on the front of the robot.
2. Switch on the robot.
3. Enable the dispensing system, including the valve controller. Refer to the dispensing equipment manuals as needed.
4. Open the dispensing program. Refer to “How to Open and Edit a Program” on page 47.

NOTE: To run a program by scanning a barcode, refer to “Running a Program by Scanning a Barcode” below.

5. Properly position the workpiece on the fixture plate.
6. Press the START button on the front of the robot.
7. When necessary, refer to the dispensing system manuals to refill the dispenser.

8. If an emergency occurs, press the EMERGENCY STOP button.

NOTE: When the EMERGENCY STOP button is pressed, the robot moves to the home position (0, 0, 0).

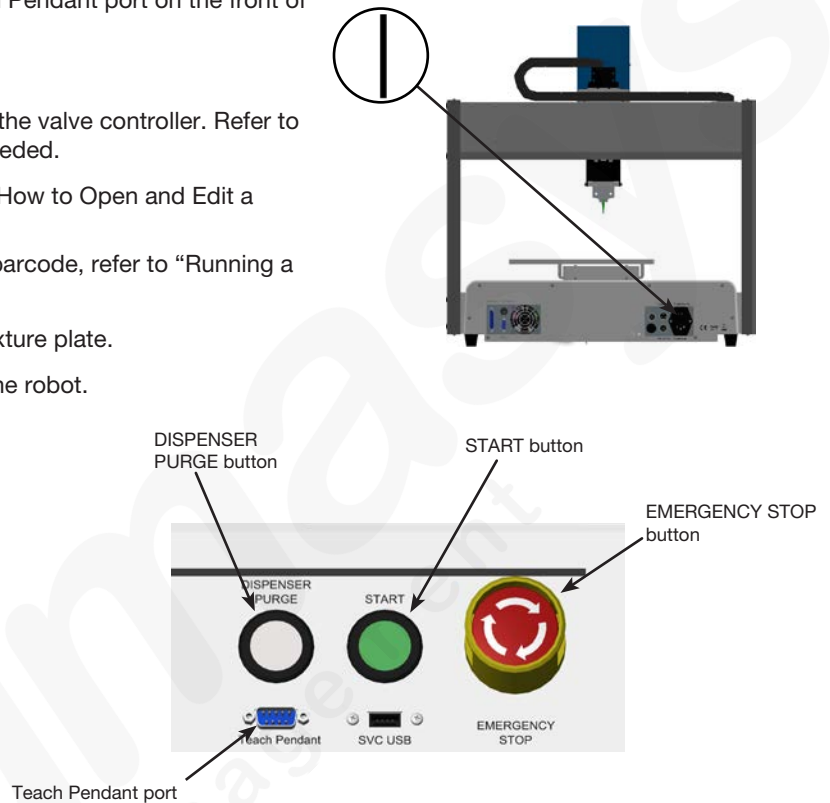

Running a Program by Scanning a Barcode

PREREQUISITES

- ❑ A barcode scanner is connected to the SVC USB port on the front of the robot.
- ❑ The program to be used for barcode scanning has been created and is named.
- ❑ A barcode with the program name embedded in it has been generated.
- ❑ Barcode scanning is enabled. Refer to “Setting Up Barcode Scanning” on page 44.
- ❑ The system is in the Run Mode. Refer to “How to Switch from Run Mode to Teach Mode” on page 46.

1. Position the workpiece on the fixture plate.
2. Use the barcode reader to scan the barcode for the dispense program to be run.
The system opens and runs the program.

Operation (continued)

Pausing During a Dispense Cycle

Press START at any time to pause the system during a dispense cycle; the tip moves to the location specified by Pause Status or stops at the next program point.

NOTE: If the system is paused during dispensing, the system shuts off the dispenser, compromising pattern integrity.

Purging the System

To purge the system, press the DISPENSER PURGE button.

NOTE: You can set up the system to purge automatically. Refer to “Auto Purge” on page 41.

Shutting Down the System

1. Refer to the dispensing system operating manuals for any special shutdown instructions.
2. Switch off the robot.

Part Numbers

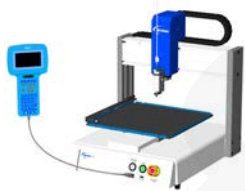

Part #	Part # Europe*	Description
7360852	7361345	Robot, E2, 200 x 200 x 50 mm (8 x 8 x 2")
7360853	7361346	Robot, E3, 300 x 300 x 100 mm (12 x 12 x 4")
7360854	7361347	Robot, E4, 400 x 400 x 100 mm (16 x 16 x 4")
7360855	7361348	Robot, E5, 500 x 500 x 150 mm (20 x 20 x 6")
7362101	7362102	Robot, E6, 620 x 500 x 150 mm (24 x 20 x 6")

*Complies with European safety regulations.

Accessories

NOTE: For replacement parts, refer to the maintenance and parts guide, available at www.nordsonefd.com/RobotMaintenanceGuide.

Safety Enclosures



Nordson EFD guarded safety enclosures integrate seamlessly with our complete line of automated dispensing systems. Featuring external dispensing controls, a safety light curtain, and an internal electrical control box and wireways for faster, safer setup, these CE-compliant enclosures also fully comply with EU Machinery Directive 2006/42/EC.

Part #	Description	Compatible Robot Models
7362738	Small safety enclosure	E2, E3
7362766	Small safety enclosure, Europe	
7362739	Large safety enclosure	E4, E5
7362767	Large safety enclosure, Europe	

Pre-Configured Output Cables

Item	Part #	Description
	7360551	Standard cable to connect the dispenser and the robot
	7360761	Single voltage initiate cable to connect the dispenser and the robot (provides different pigtails to connect to different dispensers / controllers)
	7360554	Dual voltage initiate cable to connect up to two dispensers / controllers to the robot
	7362573	I/O interface cable between the ValveMate™ 8000 and the robot when the use of all four (4) ValveMate 8000 channels are required
	7360558	Dual-connector cable to connect up to two PICO DCON Drivers or two PICO Touch™ controllers to the robot
	7362356	Dual-connector cable to connect up to two Liquidyn® V10 controllers to the robot
	7362357	Dual-connector cable to connect up to two Liquidyn V200 controllers to the robot
	7362373	Single-connector cable to connect a Liquidyn V200 controller to the robot
n/a	7015086	DB9 female straight serial cable (for RS-232 connection)
n/a	7015476	USB-to-serial converter cable

Accessories (continued)

Fixture Plates

All plates include four edge levelers and four leveling mounts.

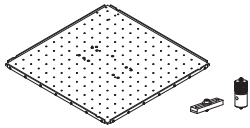



Part Number	Description
7028276	200 mm fixture plate
7028277	300 mm fixture plate
7028278	400 mm fixture plate
7028279	500 mm fixture plate

Start / Stop Box

The start / stop box accessory facilitates input / output connections for remote functions, such as an start or emergency stop button. Refer to “Example Input / Output Connections” on page 90 for schematics.

Part Number	Description
7363285	Start / stop accessory box and I/O checker, standard The I/O checker allows a user / programmer to simulate either (1) input signals from external devices or (2) outputs from the automation before physically installing any external devices.
7360865	Start / stop accessory box, European Community

Tip Aligner

Item	Part #	Description
	7360892	E Series robot tip alignment accessory kit
	7363940	Top mount / under mount accessory kit This kit allows you to mount the tip aligner in the center of the robot fixture plate, either on top of the plate or under the plate, to facilitate multi-needle or other applications.











Height Sensor

The optional height sensor can detect any variation from the original Z-height program values from workpiece to workpiece. If the Z height changes, the system detects the new Z-height value and adjusts the program accordingly. Refer to “Appendix D, Height Sensor Setup and Use” on page 130 to install and use the height sensor.

Part #	Description
7361667	Height sensor accessory kit, E / EV Series

Accessories (continued)

Mounting Brackets

Item	Part Number	Description	Item	Part Number	Description
	7360610	Syringe barrel mounting bracket		7361757	Mounting bracket for radial spinner valves
	7360611	Mounting bracket for PICO valves		7360952	Mounting bracket for the Ultimistm IV dispenser
	7361815	Mounting bracket for PICO Pulse™ valves		7362177	Mounting bracket for Liquidyn P-Jet and P-Dot valves
	7360613	Mounting bracket for all valves with mounting holes (752, 725, 741, 736, 781, 787, and 782 Series valves)		7360796	Equalizer bracket
	7361758	Universal valve mounting bracket for all valves without mounting holes (702, 754, 794, and 784S-SS Series valves)			
	7363518	Mounting bracket for 794-TC Series valves			
	7361114	Mounting bracket for xQR41 and 745 Series valves			

Troubleshooting

Teach Pendant Error Messages

When a programming error occurs, the Teach Pendant display shows the address number where the error occurs and the error message. Refer to the following table to troubleshoot Teach Pendant error messages.

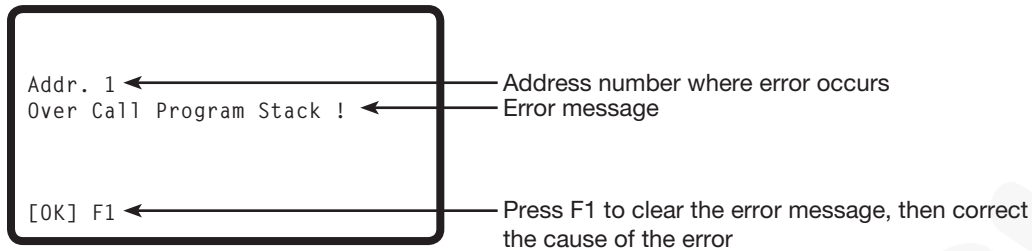

Error Message	Cause	Corrective Action
Over Call Program Stack	System cannot call the current program	Call another program number.
Error Fill Command	Line Start and Line End points after a Fill command are on the same coordinate	Correct the Line Start and Line End coordinates that occur after the Fill command.
Can't Use Call Pattern	Call Program command used and the program called for execution includes a Call Pattern command (the software does not allow this)	Create a new program that does not include a Call Pattern command.
Can't Find Fill End Point	Line End command missing after a Fill command	Ensure that a Line End command is inserted after a fill command.
Label Not Found	System cannot find the label number specified in a Goto (Label) command	Check the Label commands in the program. Use MENU2 > Jump to search for the missing label. If the label number does not exist, the system displays this error message. Correct the programming problem.
Need Line Start	Line Start command missing before a Line Passing, Arc Point, or Line End command	Enter a Line Start command before a Line Passing, Arc Point, or Line End command.
Need Line End	Line End command missing after a Line Start, Line Passing, or Arc Point command	Enter a Line End command after a Line Start, Line Passing, or Arc Point command.
Setup Error	End Program command entered after a Line Start command	Correct the programming error. An End Program command can be entered only when the previous lines of programming are logical.
Mark Point Must Separate	Mark Points 1 and 2 are the same coordinate	Ensure that Mark Points 1 and 2 are different coordinates.
Illegal Path Point	Line Start, Arc Point, and Line End coordinates are in a straight line	Correct the Arc Point coordinate so that the dispense pattern is an arc instead of a straight line.
Destination Address Error	Destination for a Group Edit > Move command already contains a command	Ensure that the destination address to which address lines are being moved is empty.

Continued on next page

Teach Pendant Error Messages (continued)





Error Message	Cause	Corrective Action
Address Not Empty	Command entered for an address which is not empty	If it is okay to replace the existing command with a new command, press F1 to continue; otherwise, move to the next empty address line.
Password Confirm Fail	Confirmation password not the same as a newly entered password	Enter the confirmation password again, ensuring that it exactly matches the newly entered password.
Password Error	Incorrect password entered for a locked program	Enter the correct password.

Diagnostic Checks (Diagnostic Menu)

You can easily test the functionality of the major system components using the Diagnostic Menu.

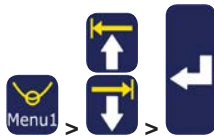
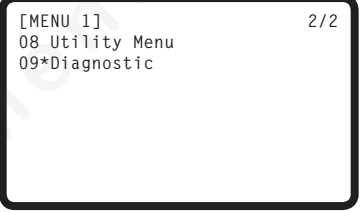

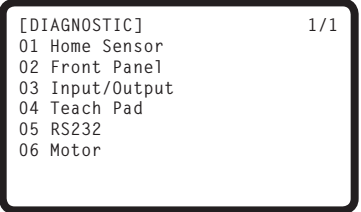
PREREQUISITES

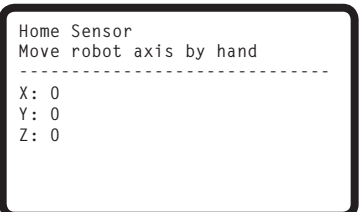
□ The system is in the Teach Mode. Refer to “How to Switch from Run Mode to Teach Mode” on page 46.

#	Key Press	Step	Teach Pendant Display
1		<ul style="list-style-type: none"> Press MENU1. MOVE UP / DOWN to DIAGNOSTIC. Press ENTER. <p>The DIAGNOSTIC menu appears.</p>	
2		<ul style="list-style-type: none"> Select the diagnostic test to perform. When the test is complete, press ESC to return to the DIAGNOSTIC menu. <p>NOTE: For reference, each test is described in the following steps.</p>	
3		<ul style="list-style-type: none"> Select HOME SENSOR to test the axis sensors. Slowly move the robot fixture plate and then the Z axis by hand. <ul style="list-style-type: none"> - If an axis is functioning properly, the displayed value for the axis changes from 0 to 1. Press ESC to return to the Diagnostic menu. 	

Continued on next page

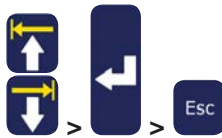
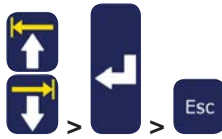
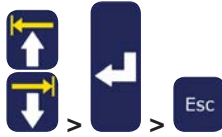
Diagnostic Checks (Diagnostic Menu) (continued)













#	Key Press	Step	Teach Pendant Display
4		<ul style="list-style-type: none"> Select FRONT PANEL to test the front panel buttons. Press each front panel button one at a time. <ul style="list-style-type: none"> - If a button is functioning properly, the displayed value for the axis changes from 0 to 1. Press ESC to return to the Diagnostic menu. 	<pre>Front Panel Press front panel buttons ----- Start Button : 0 Purge Button : 0 Emergency Stop: 0 Needle Sensor : 0</pre>
5		<ul style="list-style-type: none"> Select INPUT/OUTPUT to test any connected inputs or outputs. <ul style="list-style-type: none"> - If an input / output is functioning properly, the displayed value for the input / output changes from 0 to 1. - Refer to "I/O Port" on page 89 for the IO PORT schematic. Press ESC to return to the Diagnostic menu. 	<pre>Input/Output ----- IN : 00000000 OUT: 00000000 Press Key 1-8 Set Output Press Key 9 Set Dispenser</pre>
6		<ul style="list-style-type: none"> Select TEACH PAD to test the Teach Pendant keys. Press each TP key one at a time. <ul style="list-style-type: none"> - If a key is functioning properly, the displayed value for SCANCODE changes from 0 to 1. Press ESC to return to the Diagnostic menu. 	<pre>Teach Pad Press key on teach pad ----- SCANCODE: 0</pre>
7		<ul style="list-style-type: none"> Select RS232 to test the RS232 connection. Connect a DB9 with pins 2 and 3 shorted into the RS232 port on the back of the robot. <ul style="list-style-type: none"> - If the connection is functioning properly, the system recognizes the data being sent and received. Press ESC to return to the Diagnostic menu. 	<pre>RS232 Cross RS232 Pin2 & Pin3 ----- Send Char :00 !!! NO RESPONSE !!!</pre>
8		<ul style="list-style-type: none"> Select MOTOR to test the robot motor. Press the corresponding number key to test the motor axis. <ul style="list-style-type: none"> - If the axis motor is working, a slight back and forth movement (~10 mm) of the axis occurs. Press and hold ESC until the axis movement stops and to return to the Diagnostic menu. 	<pre>Motor Axis moves back & forth 10 mm ----- 1 X 2 Y 3 Z 0 Home</pre>

Restoring the System to the Factory Default Settings (Clear Memory)

Follow this procedure to erase all programs and return all settings to the factory default values.

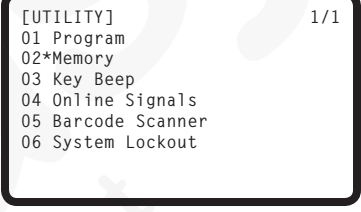
PREREQUISITES

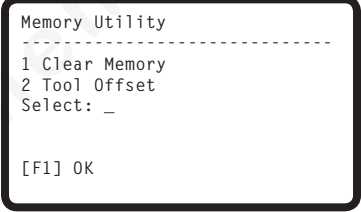
- ❑ The system is in the Teach Mode. Refer to “How to Switch from Run Mode to Teach Mode” on page 46.
- ❑ All programs have been backed up using the SAVE ALL PROGRAMS command under the USB menu. Refer to “How to Upload / Download Programs Using the SVC USB Port” on page 59.

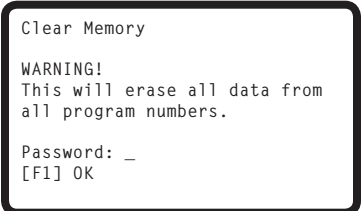
#	Key Press	Step	Teach Pendant Display
1	 >  >  > 	<ul style="list-style-type: none"> • Press MENU1. • MOVE UP / DOWN to UTILITY MENU. • Press ENTER. 	
2	 >  > 	<ul style="list-style-type: none"> • MOVE UP / DOWN to MEMORY. • Press ENTER. 	
3	 > 	<ul style="list-style-type: none"> • Press 1 CLEAR MEMORY. • Press F1. 	
4	 (9x) > 	<ul style="list-style-type: none"> • Enter the clear memory password (99999999). • Press F1 to clear the memory. <p>The system clears the memory. It does not ask for additional confirmation.</p>	

Technical Data

Dimensions

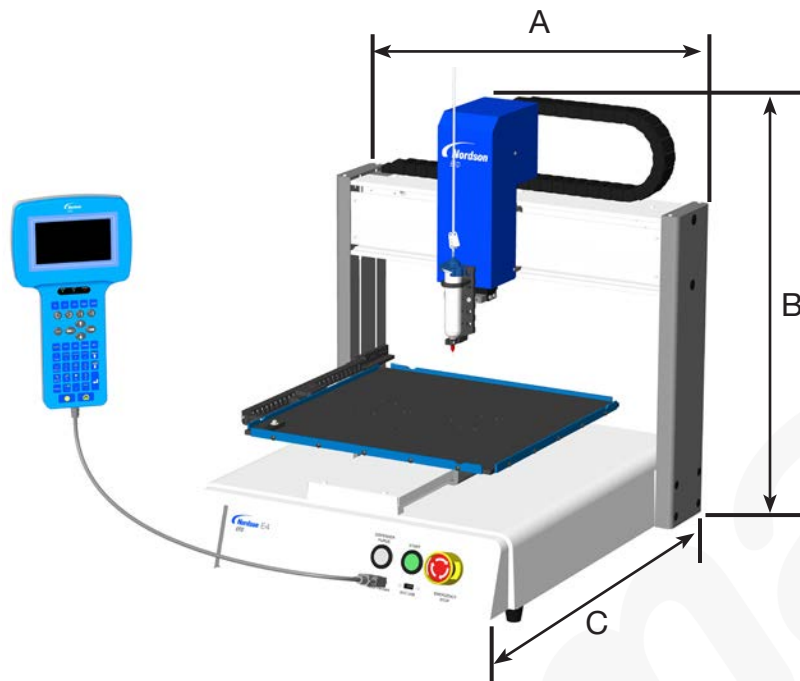

Dimension	E2	E3	E4	E5	E6
A (width)	370 mm (15")	490 mm (19")	590 mm (23")	690 mm (27")	808 mm (32")
B (height)	510 mm (20")	644 mm (25")	644 mm (25")	814 mm (32")	812 mm (32")
C (depth)	414 mm (16")	519 mm (20")	617 mm (24")	718 mm (28")	718 mm (28")

Robot Feet Mounting Hole Template

Use these dimensions to drill mounting holes for the robot feet.

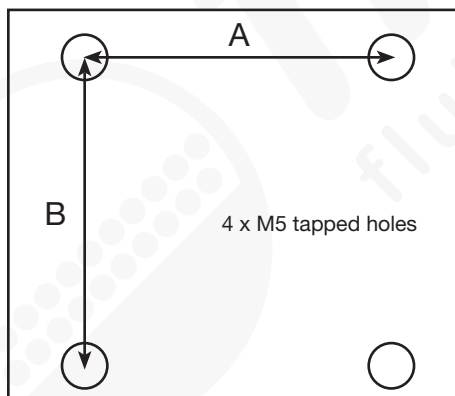

Dimension	E2	E3	E4	E5	E6
A	302 mm (11.88")	400 mm (15.75")	500 mm (19.69")	500 mm (19.69")	500 mm (19.69")
B	300 mm (11.81")	410 mm (16.14")	510 mm (20.08")	510 mm (20.08")	510 mm (20.08")

Wiring Diagrams

Dispenser Port

Pin	Description
1	NOM (Normally open)
2	COM (Common)
3	EARTH (Ground)

Maximum Voltage	Maximum Current
125 VAC	15A
250 VAC	10A
28 VDC	8A

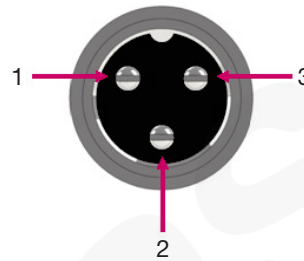
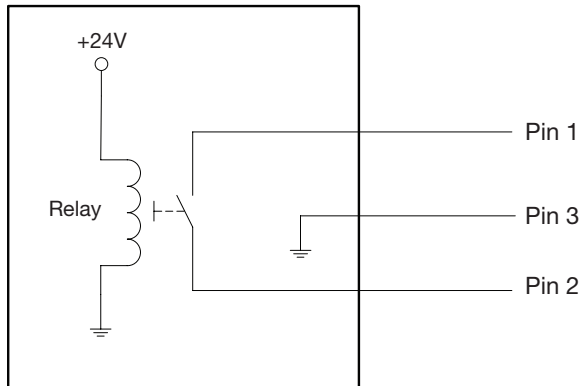

Ext. Control Port

NOTES:

- Inputs are not polarity-sensitive.
- The optional start / stop box accessory facilitates input / output connections to this port. Refer to “Accessories” on page 80 for part numbers.

Pin	Description
1	Ground
2	Start signal
3	Motor power
4	Motion idle
5	Run / Teach
6	Emergency stop
7	Emergency stop

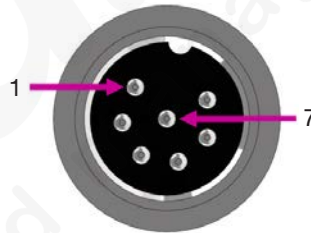

I/O Port

NOTES:

- Outputs are rated at 125 mA.
- Courtesy +24 VDC output is rated at 3.0 Amp.

Pin	Description	Pin	Description	Pin	Description
1	Input 1	10	Not connected	19	Output 6
2	Input 2	11	GND	20	Output 7
3	Input 3	12	GND	21	Output 8
4	Input 4	13	GND	22	Not connected
5	Input 5	14	Output 1	23	Not connected
6	Input 6	15	Output 2	24	+24 VDC
7	Input 7	16	Output 3	25	+24 VDC
8	Input 8	17	Output 4		
9	Not connected	18	Output 5		

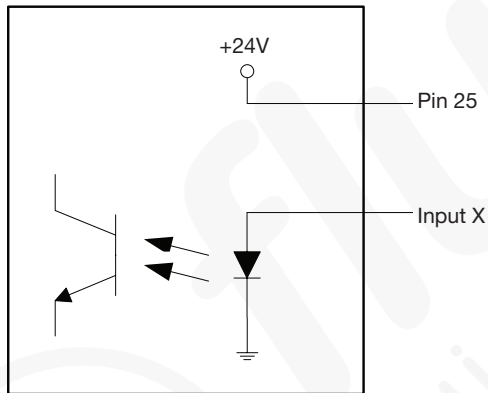
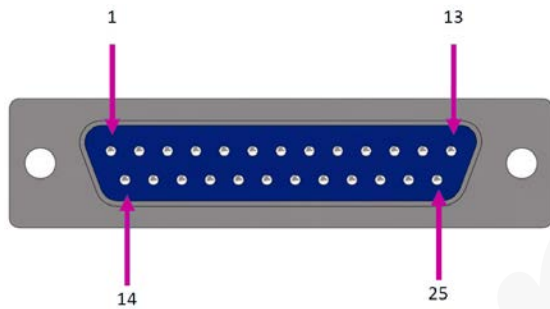

Input schematic

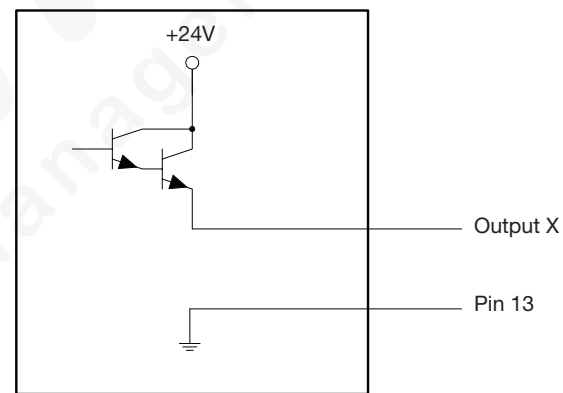

Output schematic

RS232 Port (for Remote Communication)

NOTE: Refer to "Appendix B, RS-232 Communication Protocol" on page 115 to set up remote communication.

Pin	Description	Pin	Description
1	N/C	6	N/C
2	RX	7	N/C
3	TX	8	N/C
4	N/C	9	N/C
5	GND		

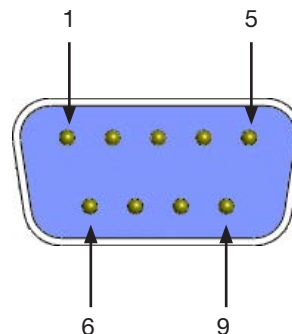

Example Input / Output Connections

You can use the I/O Port and Ext. Control port on the back of the robot to connect a variety of inputs and outputs. A spare connector is also provided with the system. The following schematics show typical examples of input / output connections to a robot.

Inputs

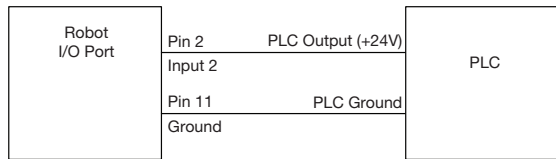
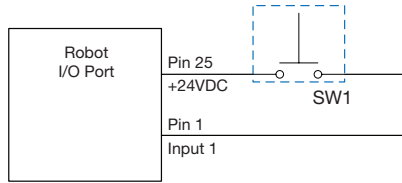

Outputs

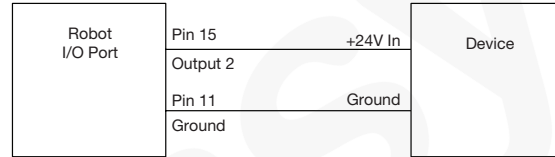
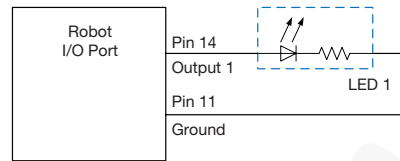

Outputs are rated at 125 mA.

External Device Powered by the Robot

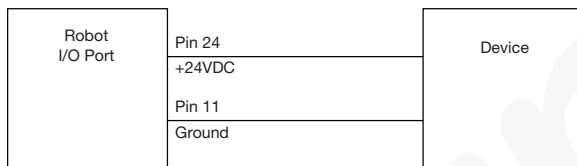

Courtesy +24 VDC output is rated at 3.0 Amp.

Start and Emergency Stop (ESTOP) Connections to Ext. Control

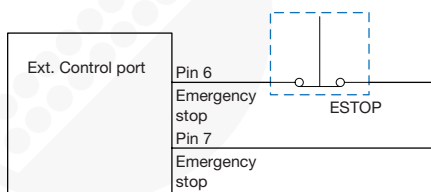
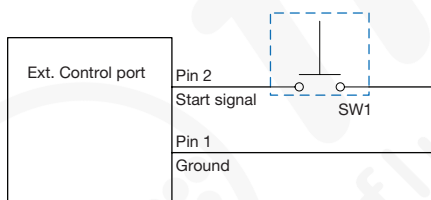

Appendix A, Type Menu Reference

This appendix provides detailed information for each setup and dispense command under the Type menu. Commands are listed in the same numerical order as they are in the Type menu.

The following rules apply to all commands:

- A command is in effect until it is superseded by another command.
- Command settings override system settings.

01 Dispense Dot

```
Dispense Dot 1/3
-----
X:           130.93 mm
Y:           37.39 mm
Z:           45.54 mm



[F1] OK [F2] Next [F3] Current
```

```
Dispense Dot 2/3
-----
Dispense Time: 0.100 s
Dwell Time:    0.00 s

[F1] OK [F2] Next
```

```
Dispense Dot 3/3
-----
Retract Distance: 100.00 mm
Retract Low:      10.0 mm/s
Retract High:     10.0 mm/s

[F1] OK [F2] Next
```

Key Press	Function												
 > 	Registers the current XYZ location as a Dispense Dot point.												
	<table border="1"> <thead> <tr> <th>Parameter</th> <th>Description</th> </tr> </thead> <tbody> <tr> <td>Dispense Time</td> <td>Duration the dispenser signal is initiated ON. Range: 0.001–1000.0 (s)</td> </tr> <tr> <td>Dwell Time</td> <td>The delay time that occurs at the end of dispensing to allow the pressure to equalize before the tip moves to the next point. Range: 0.01–1000.0 (s)</td> </tr> <tr> <td>Retract Distance</td> <td>The distance the tip raises after dispensing.</td> </tr> <tr> <td>Retract Low</td> <td>The speed at which the tip raises after dispensing. Range: 0–200 (mm/s)</td> </tr> <tr> <td>Retract High</td> <td>After the tip raises the amount specified by Retract Distance at the speed specified by Retract Low, the tip continues raising to the Z Clearance at the speed (in mm/s) specified by this setting. The purpose of specifying a Z Clearance is to allow the tip to raise high enough to clear any obstacles it encounters on its way to the next point. Refer to “13 Z Clearance” on page 103. Range: 30–200 (mm/s)</td> </tr> </tbody> </table>	Parameter	Description	Dispense Time	Duration the dispenser signal is initiated ON. Range: 0.001–1000.0 (s)	Dwell Time	The delay time that occurs at the end of dispensing to allow the pressure to equalize before the tip moves to the next point. Range: 0.01–1000.0 (s)	Retract Distance	The distance the tip raises after dispensing.	Retract Low	The speed at which the tip raises after dispensing. Range: 0–200 (mm/s)	Retract High	After the tip raises the amount specified by Retract Distance at the speed specified by Retract Low, the tip continues raising to the Z Clearance at the speed (in mm/s) specified by this setting. The purpose of specifying a Z Clearance is to allow the tip to raise high enough to clear any obstacles it encounters on its way to the next point. Refer to “13 Z Clearance” on page 103. Range: 30–200 (mm/s)
Parameter	Description												
Dispense Time	Duration the dispenser signal is initiated ON. Range: 0.001–1000.0 (s)												
Dwell Time	The delay time that occurs at the end of dispensing to allow the pressure to equalize before the tip moves to the next point. Range: 0.01–1000.0 (s)												
Retract Distance	The distance the tip raises after dispensing.												
Retract Low	The speed at which the tip raises after dispensing. Range: 0–200 (mm/s)												
Retract High	After the tip raises the amount specified by Retract Distance at the speed specified by Retract Low, the tip continues raising to the Z Clearance at the speed (in mm/s) specified by this setting. The purpose of specifying a Z Clearance is to allow the tip to raise high enough to clear any obstacles it encounters on its way to the next point. Refer to “13 Z Clearance” on page 103. Range: 30–200 (mm/s)												

Appendix A, Type Menu Reference (continued)



02 Line Start

Line Start	1/2

X:	130.93 mm
Y:	37.39 mm
Z:	45.54 mm
[F1] OK [F2] Next [F3] Current	

Line Start	2/2

Line Speed:	10.0 mm/s
Pre-move Delay:	0.00 s
Settling Distance:	0.00 mm
Dispenser Off(0)/On(1):	1
[F1] OK [F2] Next	

Key Press	Function										
 > 	Registers the current XYZ location as a Line Start point for line dispensing.										
	<table border="1"> <thead> <tr> <th>Parameter</th> <th>Description</th> </tr> </thead> <tbody> <tr> <td>Line Speed</td> <td>The speed at which the dispensing tip travels at the location in the program where this command is inserted, thus overriding the default line speed setting. Range: 0–500 (mm/s)</td> </tr> <tr> <td>Pre-move Delay</td> <td>The time the dispenser stays open at the start of a line before moving. This delay time prevents the tip from moving along the line until fluid is flowing. Range: 0–100 (s)</td> </tr> <tr> <td>Settling Distance</td> <td>The distance the robot moves from the beginning of a Line Start before the dispenser turns on. This distance allows the robot sufficient time to build speed and is used primarily to eliminate the deposit of too much fluid at the beginning of a line. Range: 0–100 (mm)</td> </tr> <tr> <td>Dispenser Off (0)/On(1)</td> <td>Turns the dispenser OFF (0) or ON (1) at the current address.</td> </tr> </tbody> </table>	Parameter	Description	Line Speed	The speed at which the dispensing tip travels at the location in the program where this command is inserted, thus overriding the default line speed setting. Range: 0–500 (mm/s)	Pre-move Delay	The time the dispenser stays open at the start of a line before moving. This delay time prevents the tip from moving along the line until fluid is flowing. Range: 0–100 (s)	Settling Distance	The distance the robot moves from the beginning of a Line Start before the dispenser turns on. This distance allows the robot sufficient time to build speed and is used primarily to eliminate the deposit of too much fluid at the beginning of a line. Range: 0–100 (mm)	Dispenser Off (0)/On(1)	Turns the dispenser OFF (0) or ON (1) at the current address.
Parameter	Description										
Line Speed	The speed at which the dispensing tip travels at the location in the program where this command is inserted, thus overriding the default line speed setting. Range: 0–500 (mm/s)										
Pre-move Delay	The time the dispenser stays open at the start of a line before moving. This delay time prevents the tip from moving along the line until fluid is flowing. Range: 0–100 (s)										
Settling Distance	The distance the robot moves from the beginning of a Line Start before the dispenser turns on. This distance allows the robot sufficient time to build speed and is used primarily to eliminate the deposit of too much fluid at the beginning of a line. Range: 0–100 (mm)										
Dispenser Off (0)/On(1)	Turns the dispenser OFF (0) or ON (1) at the current address.										



03 Line Passing

Line Passing	1/2

X:	130.93 mm
Y:	37.39 mm
Z:	45.54 mm
[F1] OK [F2] Next [F3] Current	

Line Passing	2/2



Line Speed:	10.0 mm/s
Node Time:	0.001 s
Dispenser Off(0)/On(1):	1
[F1] OK [F2] Next	

Key Press	Function								
 > 	Registers the current XYZ location as a Line Passing point. This is a location on a line where the dispensing tip changes direction, such as at the corner on a rectangle. NOTE: Also use a Line Passing point before and after an Arc Point command.								
	<table border="1"> <thead> <tr> <th>Parameter</th> <th>Description</th> </tr> </thead> <tbody> <tr> <td>Line Speed</td> <td>The speed at which the dispensing tip travels at the location in the program where this command is inserted, thus overriding the default system line speed setting. Range: 0–500 (mm/s)</td> </tr> <tr> <td>Node Time</td> <td>The delay time that occurs only for a Line Passing command. The dispensing tip passes through the Line Passing point and waits at the Line Passing point, with the dispenser activated, for the specified time period. Range: 0–100 (s)</td> </tr> <tr> <td>Dispenser Off(0)/On(1)</td> <td>Turns the dispenser OFF (0) or ON (1) at the current address.</td> </tr> </tbody> </table>	Parameter	Description	Line Speed	The speed at which the dispensing tip travels at the location in the program where this command is inserted, thus overriding the default system line speed setting. Range: 0–500 (mm/s)	Node Time	The delay time that occurs only for a Line Passing command. The dispensing tip passes through the Line Passing point and waits at the Line Passing point, with the dispenser activated, for the specified time period. Range: 0–100 (s)	Dispenser Off(0)/On(1)	Turns the dispenser OFF (0) or ON (1) at the current address.
Parameter	Description								
Line Speed	The speed at which the dispensing tip travels at the location in the program where this command is inserted, thus overriding the default system line speed setting. Range: 0–500 (mm/s)								
Node Time	The delay time that occurs only for a Line Passing command. The dispensing tip passes through the Line Passing point and waits at the Line Passing point, with the dispenser activated, for the specified time period. Range: 0–100 (s)								
Dispenser Off(0)/On(1)	Turns the dispenser OFF (0) or ON (1) at the current address.								

Appendix A, Type Menu Reference (continued)

04 Arc Point

Arc Point	
X:	130.93 mm
Y:	37.39 mm
Z:	45.54 mm
[F1] OK [F3] Current	



Key Press	Function
 > 	Registers the current XYZ location as an Arc Point. Arc points dispense material along an arc or circular path.

05 Line End

Line End 1/4	
X:	130.93 mm
Y:	37.39 mm
Z:	45.54 mm
[F1] OK [F2] Next [F3] Current	

Line End 2/4	
Shutoff Distance:	0.00 mm
Shutoff Delay:	0.00 s
Dwell Time:	0.00 s
[F1] OK [F2] Next	

Line End 3/4	
Backtrack Length:	0.00 mm
Backtrack Gap:	0.00 mm
Backtrack Speed:	10.0 mm/s
Type 0 1\ 2 3/ 4[:	0
[F1] OK [F2] Next	

Key Press	Function														
 > 	Registers the current XYZ location as a Line End point.														
	<table border="1"> <thead> <tr> <th>Parameter</th> <th>Description</th> </tr> </thead> <tbody> <tr> <td>Shutoff Distance</td> <td>The distance before the end of a line when the dispenser closes to prevent excess fluid from being deposited at the end of the line, as shown in the illustration below. Range: 0–100 (s)</td> </tr> <tr> <td>Shutoff Delay</td> <td>The time the dispenser stays open after it stops at the end of a line. Range: 0–100 (s)</td> </tr> <tr> <td>Dwell Time</td> <td>The delay time that occurs at the end of a line after the dispenser turns off. This allows the pressure to equalize before the tip moves to the next point. Range: 0–1000 (s)</td> </tr> <tr> <td>Backtrack Length</td> <td>The distance the dispensing tip travels away from the Line End point. Range: 0–100 (mm)</td> </tr> <tr> <td>Backtrack Gap</td> <td>The distance the dispensing tip raises as it moves away from the Line End point. This value must be less than the Z Clearance value for that point. Range: 0–100 (mm)</td> </tr> <tr> <td>Backtrack Speed</td> <td>The speed of the dispensing tip backtrack movement. Range: 0.1–200 (mm/s)</td> </tr> </tbody> </table>	Parameter	Description	Shutoff Distance	The distance before the end of a line when the dispenser closes to prevent excess fluid from being deposited at the end of the line, as shown in the illustration below. Range: 0–100 (s)	Shutoff Delay	The time the dispenser stays open after it stops at the end of a line. Range: 0–100 (s)	Dwell Time	The delay time that occurs at the end of a line after the dispenser turns off. This allows the pressure to equalize before the tip moves to the next point. Range: 0–1000 (s)	Backtrack Length	The distance the dispensing tip travels away from the Line End point. Range: 0–100 (mm)	Backtrack Gap	The distance the dispensing tip raises as it moves away from the Line End point. This value must be less than the Z Clearance value for that point. Range: 0–100 (mm)	Backtrack Speed	The speed of the dispensing tip backtrack movement. Range: 0.1–200 (mm/s)
Parameter	Description														
Shutoff Distance	The distance before the end of a line when the dispenser closes to prevent excess fluid from being deposited at the end of the line, as shown in the illustration below. Range: 0–100 (s)														
Shutoff Delay	The time the dispenser stays open after it stops at the end of a line. Range: 0–100 (s)														
Dwell Time	The delay time that occurs at the end of a line after the dispenser turns off. This allows the pressure to equalize before the tip moves to the next point. Range: 0–1000 (s)														
Backtrack Length	The distance the dispensing tip travels away from the Line End point. Range: 0–100 (mm)														
Backtrack Gap	The distance the dispensing tip raises as it moves away from the Line End point. This value must be less than the Z Clearance value for that point. Range: 0–100 (mm)														
Backtrack Speed	The speed of the dispensing tip backtrack movement. Range: 0.1–200 (mm/s)														
	<i>Continued on next page</i>														

Appendix A, Type Menu Reference (continued)

05 Line End (continued)

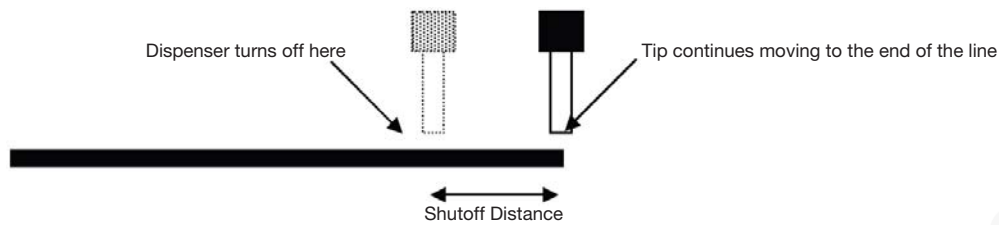



Illustration of the Shutoff Distance parameter

Line End	3/4

Backtrack Length:	0.00 mm
Backtrack Gap:	0.00 mm
Backtrack Speed:	10.0 mm/s
Type 0 1\ 2] 3/ 4[:	0
[F1] OK [F2] Next	

Line End	4/4

Retract Distance:	0.00 mm
Retract Low:	20.0 mm/s
Retract High:	80.0 mm/s
[F1] OK [F2] Next	

Key Press	Function										
 > 	See previous page.										
	<table border="1"> <thead> <tr> <th>Parameter</th> <th>Description</th> </tr> </thead> <tbody> <tr> <td>Type</td> <td>Refer to “Example Illustrations of Backtrack Setup Parameters” on page 95. 0 (Normal) The dispensing tip moves straight up for the height entered for Backtrack Gap. 1 (Back) The dispensing tip moves backward at an angle for the distance and height entered for Backtrack Length and Backtrack Gap. 2 (Square Back) The dispensing tip moves up and then back at the distance and height entered for Backtrack Length and Backtrack Gap. 3 (Forward) The dispensing tip moves forward at an angle for the distance and height entered for Backtrack Length and Backtrack Gap. 4 (Square Forward) The dispensing tip moves up and then forward at the distance and height entered for Backtrack Length and Backtrack Gap.</td> </tr> <tr> <td>Retract Distance</td> <td>The distance the tip raises after dispensing. Range: 0–50 (mm)</td> </tr> <tr> <td>Retract Low</td> <td>The speed at which the tip raises after dispensing. Range: 0–200 (mm/s)</td> </tr> <tr> <td>Retract High</td> <td>After the tip raises the amount specified by Retract Distance at the speed specified by Retract Low, the tip continues raising to the Z Clearance at the speed specified by this setting. The purpose of specifying a Z Clearance is to allow the tip to raise high enough to clear any obstacles it encounters on the way to the next point. Refer to “13 Z Clearance” on page 103. Range: 30–200 (mm/s)</td> </tr> </tbody> </table>	Parameter	Description	Type	Refer to “Example Illustrations of Backtrack Setup Parameters” on page 95. 0 (Normal) The dispensing tip moves straight up for the height entered for Backtrack Gap. 1 (Back) The dispensing tip moves backward at an angle for the distance and height entered for Backtrack Length and Backtrack Gap. 2 (Square Back) The dispensing tip moves up and then back at the distance and height entered for Backtrack Length and Backtrack Gap. 3 (Forward) The dispensing tip moves forward at an angle for the distance and height entered for Backtrack Length and Backtrack Gap. 4 (Square Forward) The dispensing tip moves up and then forward at the distance and height entered for Backtrack Length and Backtrack Gap.	Retract Distance	The distance the tip raises after dispensing. Range: 0–50 (mm)	Retract Low	The speed at which the tip raises after dispensing. Range: 0–200 (mm/s)	Retract High	After the tip raises the amount specified by Retract Distance at the speed specified by Retract Low, the tip continues raising to the Z Clearance at the speed specified by this setting. The purpose of specifying a Z Clearance is to allow the tip to raise high enough to clear any obstacles it encounters on the way to the next point. Refer to “13 Z Clearance” on page 103. Range: 30–200 (mm/s)
Parameter	Description										
Type	Refer to “Example Illustrations of Backtrack Setup Parameters” on page 95. 0 (Normal) The dispensing tip moves straight up for the height entered for Backtrack Gap. 1 (Back) The dispensing tip moves backward at an angle for the distance and height entered for Backtrack Length and Backtrack Gap. 2 (Square Back) The dispensing tip moves up and then back at the distance and height entered for Backtrack Length and Backtrack Gap. 3 (Forward) The dispensing tip moves forward at an angle for the distance and height entered for Backtrack Length and Backtrack Gap. 4 (Square Forward) The dispensing tip moves up and then forward at the distance and height entered for Backtrack Length and Backtrack Gap.										
Retract Distance	The distance the tip raises after dispensing. Range: 0–50 (mm)										
Retract Low	The speed at which the tip raises after dispensing. Range: 0–200 (mm/s)										
Retract High	After the tip raises the amount specified by Retract Distance at the speed specified by Retract Low, the tip continues raising to the Z Clearance at the speed specified by this setting. The purpose of specifying a Z Clearance is to allow the tip to raise high enough to clear any obstacles it encounters on the way to the next point. Refer to “13 Z Clearance” on page 103. Range: 30–200 (mm/s)										

Appendix A, Type Menu Reference (continued)

Example Illustrations of Backtrack Setup Parameters

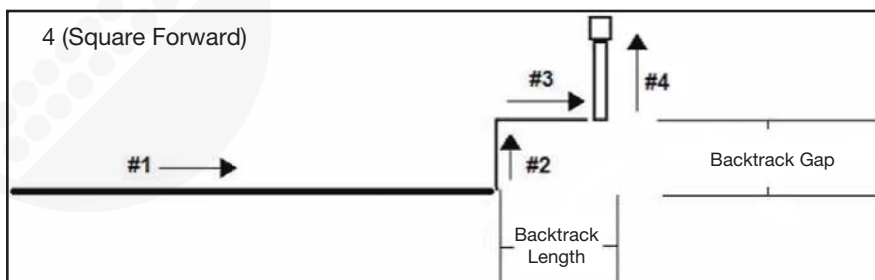
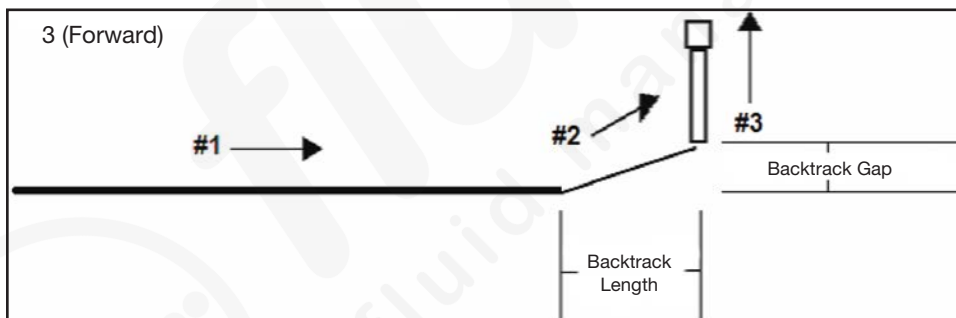
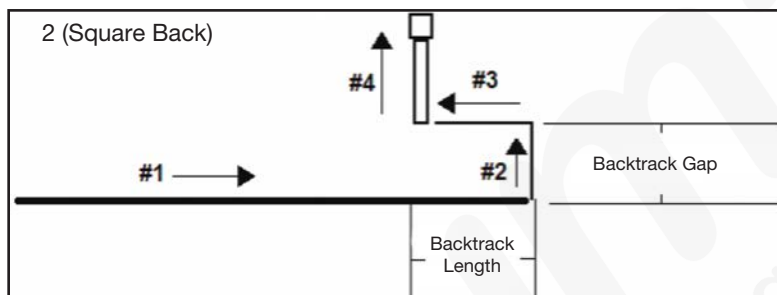
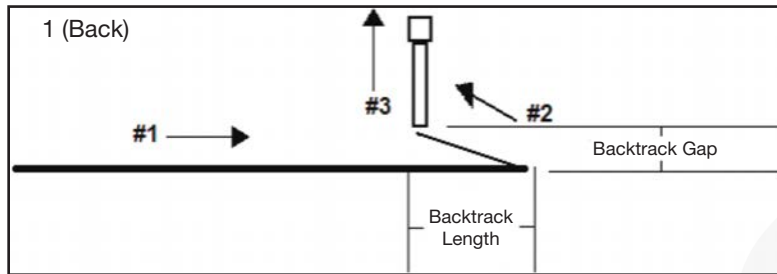
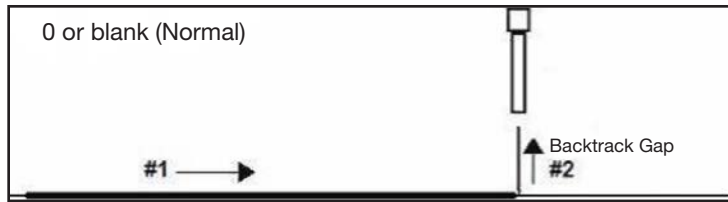

Appendix A, Type Menu Reference (continued)



06 Circle

```
Circle
-----
[F1] 3-Point [F2] Center Point
-----
```

```
Circle 1/5
-----
X: 130.93 mm
Y: 37.39 mm
Z: 45.54 mm
-----
[F1] OK [F2] Next [F3] Current
```

```
Circle 2/5
-----
Circle Speed: 10.0 mm/s
Diameter: 0.00 mm
Start Angle: 0.0 deg
End Angle: 360.0 deg
-----
[F1] OK [F2] Next
```

```
Circle 3/5
-----
Pre-move Delay: 0.00 s
Settling Distance: 0.00 mm
Shutoff Distance: 0.00 mm
Shutoff Delay: 0.00 s
Dwell Time: 0.00 s
-----
[F1] OK [F2] Next
```

Key Press	Function																				
 > 	Registers a circle. Circles are created by selecting three points on the circle diameter or by entering a center point for the circle (refer to “How to Make a Circle” on page 67).																				
	<table border="1"> <thead> <tr> <th>Parameter</th> <th>Description</th> </tr> </thead> <tbody> <tr> <td>Circle Speed</td> <td>The speed at which the dispensing tip travels when making the circle, thus overriding the default system move speed setting. Range: 0.1–400 (mm/s)</td> </tr> <tr> <td>Diameter</td> <td>The diameter of the circle. Range: 0.01–400 (mm)</td> </tr> <tr> <td>Start Angle</td> <td>The angle (in degrees) from the center of the circle where dispensing for the start of the circle begins. The default setting (0 degrees) equates to the 3:00 position. Default: 0 (degrees) Range: 0 to ±360 (degrees)</td> </tr> <tr> <td>End Angle</td> <td>The angle (in degrees) after the Start Angle value at which dispensing stops. Default: 0 (degrees) Range: 0–10000 (degrees) <ul style="list-style-type: none"> To dispense in a counterclockwise direction, enter a positive value. To dispense in a clockwise direction, enter a negative value. </td> </tr> <tr> <td>Pre-move Delay</td> <td>The time the dispenser stays open at the start of a circle before moving. This delay time prevents the tip from moving along the circle until fluid is flowing. Range: 0–100 (s)</td> </tr> <tr> <td>Settling Distance</td> <td>The distance the robot moves from the beginning of a circle before the dispenser turns on. This distance allows the robot sufficient time to build speed and is used primarily to eliminate the deposit of too much fluid at the beginning of a circle. Range: 0–100 (mm)</td> </tr> <tr> <td>Shutoff Distance</td> <td>The distance before the end of a circle when the dispenser closes to prevent excess fluid from being deposited at the end of the circle. Range: 0–100 (mm)</td> </tr> <tr> <td>Shutoff Delay</td> <td>The time the dispenser stays open after it stops at the end of a circle. Range: 0–100 (s)</td> </tr> <tr> <td>Dwell Time</td> <td>The delay time that occurs at the end of a circle after the dispenser closes. This allows the pressure to equalize before the tip moves to the next point. Range: 0–1000 (s)</td> </tr> </tbody> </table>	Parameter	Description	Circle Speed	The speed at which the dispensing tip travels when making the circle, thus overriding the default system move speed setting. Range: 0.1–400 (mm/s)	Diameter	The diameter of the circle. Range: 0.01–400 (mm)	Start Angle	The angle (in degrees) from the center of the circle where dispensing for the start of the circle begins. The default setting (0 degrees) equates to the 3:00 position. Default: 0 (degrees) Range: 0 to ±360 (degrees)	End Angle	The angle (in degrees) after the Start Angle value at which dispensing stops. Default: 0 (degrees) Range: 0–10000 (degrees) <ul style="list-style-type: none"> To dispense in a counterclockwise direction, enter a positive value. To dispense in a clockwise direction, enter a negative value. 	Pre-move Delay	The time the dispenser stays open at the start of a circle before moving. This delay time prevents the tip from moving along the circle until fluid is flowing. Range: 0–100 (s)	Settling Distance	The distance the robot moves from the beginning of a circle before the dispenser turns on. This distance allows the robot sufficient time to build speed and is used primarily to eliminate the deposit of too much fluid at the beginning of a circle. Range: 0–100 (mm)	Shutoff Distance	The distance before the end of a circle when the dispenser closes to prevent excess fluid from being deposited at the end of the circle. Range: 0–100 (mm)	Shutoff Delay	The time the dispenser stays open after it stops at the end of a circle. Range: 0–100 (s)	Dwell Time	The delay time that occurs at the end of a circle after the dispenser closes. This allows the pressure to equalize before the tip moves to the next point. Range: 0–1000 (s)
Parameter	Description																				
Circle Speed	The speed at which the dispensing tip travels when making the circle, thus overriding the default system move speed setting. Range: 0.1–400 (mm/s)																				
Diameter	The diameter of the circle. Range: 0.01–400 (mm)																				
Start Angle	The angle (in degrees) from the center of the circle where dispensing for the start of the circle begins. The default setting (0 degrees) equates to the 3:00 position. Default: 0 (degrees) Range: 0 to ±360 (degrees)																				
End Angle	The angle (in degrees) after the Start Angle value at which dispensing stops. Default: 0 (degrees) Range: 0–10000 (degrees) <ul style="list-style-type: none"> To dispense in a counterclockwise direction, enter a positive value. To dispense in a clockwise direction, enter a negative value. 																				
Pre-move Delay	The time the dispenser stays open at the start of a circle before moving. This delay time prevents the tip from moving along the circle until fluid is flowing. Range: 0–100 (s)																				
Settling Distance	The distance the robot moves from the beginning of a circle before the dispenser turns on. This distance allows the robot sufficient time to build speed and is used primarily to eliminate the deposit of too much fluid at the beginning of a circle. Range: 0–100 (mm)																				
Shutoff Distance	The distance before the end of a circle when the dispenser closes to prevent excess fluid from being deposited at the end of the circle. Range: 0–100 (mm)																				
Shutoff Delay	The time the dispenser stays open after it stops at the end of a circle. Range: 0–100 (s)																				
Dwell Time	The delay time that occurs at the end of a circle after the dispenser closes. This allows the pressure to equalize before the tip moves to the next point. Range: 0–1000 (s)																				
	<i>Continued on next page</i>																				

Appendix A, Type Menu Reference (continued)

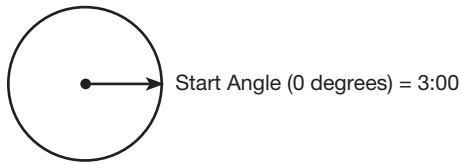

06 Circle (continued)



The 0 (degrees) default setting for Start Angle is at 3:00



Circle		4/5
Backtrack Length:	0.00 mm	
Backtrack Gap:	0.00 mm	
Backtrack Speed:	10.0 mm/s	
Type 0 1\ 2] 3/ 4[:	0	
[F1] OK [F2] Next		

Circle		5/5
Retract Distance:	0.00 mm	
Retract Low:	10.0 mm/s	
Retract High:	80.0 mm/s	
[F1] OK [F2] Next		

Key Press	Function																
 > 	See previous page.																
	<table border="1"> <thead> <tr> <th>Parameter</th> <th>Description</th> </tr> </thead> <tbody> <tr> <td>Backtrack Length</td> <td>The distance the dispensing tip travels away from the circle end point. Range: 0–100 (mm)</td> </tr> <tr> <td>Backtrack Gap</td> <td>The distance the dispensing tip raises as it moves away from the circle end point. This value must be less than the Z Clearance value for that point. Range: 0–100 (mm)</td> </tr> <tr> <td>Backtrack Speed</td> <td>The speed of the dispensing tip backtrack movement. Range: 0–200 (mm/s)</td> </tr> <tr> <td>Type</td> <td>Refer to “Example Illustrations of Backtrack Setup Parameters” on page 95. 0 (Normal) The dispensing tip moves straight up for the height entered for Backtrack Gap. 1 (Back) The dispensing tip moves backward at an angle for the distance and height entered for Backtrack Length and Backtrack Gap. 2 (Square Back) The dispensing tip moves up and then back at the distance and height entered for Backtrack Length and Backtrack Gap. 3 (Forward) The dispensing tip moves forward at an angle for the distance and height entered for Backtrack Length and Backtrack Gap. 4 (Square Forward) The dispensing tip moves up and then forward at the distance and height entered for Backtrack Length and Backtrack Gap.</td> </tr> <tr> <td>Retract Distance</td> <td>The distance (in mm) the tip raises after dispensing. Range: 0–50 (mm)</td> </tr> <tr> <td>Retract Low</td> <td>The speed at which the tip raises after dispensing. Range: 0–200 (mm/s)</td> </tr> <tr> <td>Retract High</td> <td>After the tip raises the amount specified by Retract Distance at the speed specified by Retract Low, the tip continues raising to the Z Clearance at the speed specified by this setting. The purpose of specifying a Z Clearance is to allow the tip to raise high enough to clear any obstacles it encounters on the way to the next point. Range: 30–200 (mm/s)</td> </tr> </tbody> </table>	Parameter	Description	Backtrack Length	The distance the dispensing tip travels away from the circle end point. Range: 0–100 (mm)	Backtrack Gap	The distance the dispensing tip raises as it moves away from the circle end point. This value must be less than the Z Clearance value for that point. Range: 0–100 (mm)	Backtrack Speed	The speed of the dispensing tip backtrack movement. Range: 0–200 (mm/s)	Type	Refer to “Example Illustrations of Backtrack Setup Parameters” on page 95. 0 (Normal) The dispensing tip moves straight up for the height entered for Backtrack Gap. 1 (Back) The dispensing tip moves backward at an angle for the distance and height entered for Backtrack Length and Backtrack Gap. 2 (Square Back) The dispensing tip moves up and then back at the distance and height entered for Backtrack Length and Backtrack Gap. 3 (Forward) The dispensing tip moves forward at an angle for the distance and height entered for Backtrack Length and Backtrack Gap. 4 (Square Forward) The dispensing tip moves up and then forward at the distance and height entered for Backtrack Length and Backtrack Gap.	Retract Distance	The distance (in mm) the tip raises after dispensing. Range: 0–50 (mm)	Retract Low	The speed at which the tip raises after dispensing. Range: 0–200 (mm/s)	Retract High	After the tip raises the amount specified by Retract Distance at the speed specified by Retract Low, the tip continues raising to the Z Clearance at the speed specified by this setting. The purpose of specifying a Z Clearance is to allow the tip to raise high enough to clear any obstacles it encounters on the way to the next point. Range: 30–200 (mm/s)
Parameter	Description																
Backtrack Length	The distance the dispensing tip travels away from the circle end point. Range: 0–100 (mm)																
Backtrack Gap	The distance the dispensing tip raises as it moves away from the circle end point. This value must be less than the Z Clearance value for that point. Range: 0–100 (mm)																
Backtrack Speed	The speed of the dispensing tip backtrack movement. Range: 0–200 (mm/s)																
Type	Refer to “Example Illustrations of Backtrack Setup Parameters” on page 95. 0 (Normal) The dispensing tip moves straight up for the height entered for Backtrack Gap. 1 (Back) The dispensing tip moves backward at an angle for the distance and height entered for Backtrack Length and Backtrack Gap. 2 (Square Back) The dispensing tip moves up and then back at the distance and height entered for Backtrack Length and Backtrack Gap. 3 (Forward) The dispensing tip moves forward at an angle for the distance and height entered for Backtrack Length and Backtrack Gap. 4 (Square Forward) The dispensing tip moves up and then forward at the distance and height entered for Backtrack Length and Backtrack Gap.																
Retract Distance	The distance (in mm) the tip raises after dispensing. Range: 0–50 (mm)																
Retract Low	The speed at which the tip raises after dispensing. Range: 0–200 (mm/s)																
Retract High	After the tip raises the amount specified by Retract Distance at the speed specified by Retract Low, the tip continues raising to the Z Clearance at the speed specified by this setting. The purpose of specifying a Z Clearance is to allow the tip to raise high enough to clear any obstacles it encounters on the way to the next point. Range: 30–200 (mm/s)																



Appendix A, Type Menu Reference (continued)

07 End Program

Key Press	Function
 > 	Registers the current address as the end of the program. End Program returns the dispensing tip to the home position or to the Park Position. This command must occur at the end of a dispense program.

08 Spline Node

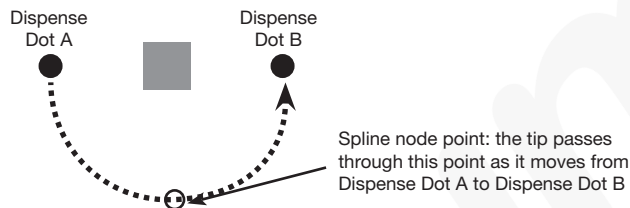

Spline Node	
X:	130.93 mm
Y:	37.39 mm
Z:	45.54 mm
[F1] OK [F3] Current	

Key Press	Function
 >  	Changes the path the tip makes as it moves between two points. Enter a Spline Node point to make the tip move through the spline node point as it moves from one point to another. This is useful for avoiding an obstacle on a workpiece.



09 Spline Move Speed

Spline Move Speed	
Speed:	80.0 mm/s
[F1] OK	



Key Press	Function
 >  	The speed at which the dispensing tip travels when it moves through a Spline Node point. Range: 0.1–500 (mm/s)

Appendix A, Type Menu Reference (continued)

10 Label

Label	



Label:	2
[F1] OK	

Key Press	Function
 > 	Registers a numeric label that can be used as a reference in the Goto (Label), Loop, Step & Repeat, Call Pattern, Call Subroutine, and Call Program commands. <ul style="list-style-type: none"> The number of labels allowed in a program is 1-9999.

11 Goto

Goto	

Label:	2
[F1] OK	

Key Press	Function
 >  	The program jumps to the address line in the program that contains the specified label.

Appendix A, Type Menu Reference (continued)

12 Step & Repeat 2D

```

Step & Repeat
-----
[F1] Step & Repeat 2D
[F2] Step & Repeat 3D
-----
    
```

```



Step & Repeat 2D          1/2
-----
Direction X(1)/Y(2):    1
X Offset:                1.00 mm
Y Offset:                1.00 mm

[F1] OK [F2] Next
    
```

```

Step & Repeat 2D          2/2
-----
Column (X):             1
Row (Y):                1
Path S(1)/N(2):        1
Goto Label:             1

[F1] OK [F2] Next
    
```

Key Press	Function																
 > 	Enables the repeat of the dispensing pattern onto many identical workpieces that are mounted on a fixture plate and aligned in rows and columns.																
	<table border="1"> <thead> <tr> <th>Parameter</th> <th>Description (refer to the diagram below and to “Example Illustrations of Step & Repeat Parameters” on page 101)</th> </tr> </thead> <tbody> <tr> <td>Direction</td> <td>The direction the tip moves along the XY axes. Select X(1) to give priority to the X axis or Y(2) to give priority to the Y axis.</td> </tr> <tr> <td>X Offset</td> <td>The distance (in mm) between each workpiece in the X direction. Range: 0.1–100 (mm)</td> </tr> <tr> <td>Y Offset</td> <td>The distance (in mm) between each workpiece in the Y direction. Range: 0.1–100 (mm)</td> </tr> <tr> <td>Columns (X)</td> <td>The number of columns in the X direction. Range: 1–9999</td> </tr> <tr> <td>Rows (Y)</td> <td>The number of rows in the Y direction. Range: 1–9999</td> </tr> <tr> <td>Path S(1)/N(2)</td> <td>The path of pattern travel. Select 1 for an S-shaped pattern or 2 for an N-shaped pattern.</td> </tr> <tr> <td>Goto Label</td> <td>The address where the Step & Repeat X command begins.</td> </tr> </tbody> </table>	Parameter	Description (refer to the diagram below and to “Example Illustrations of Step & Repeat Parameters” on page 101)	Direction	The direction the tip moves along the XY axes. Select X(1) to give priority to the X axis or Y(2) to give priority to the Y axis.	X Offset	The distance (in mm) between each workpiece in the X direction. Range: 0.1–100 (mm)	Y Offset	The distance (in mm) between each workpiece in the Y direction. Range: 0.1–100 (mm)	Columns (X)	The number of columns in the X direction. Range: 1–9999	Rows (Y)	The number of rows in the Y direction. Range: 1–9999	Path S(1)/N(2)	The path of pattern travel. Select 1 for an S-shaped pattern or 2 for an N-shaped pattern.	Goto Label	The address where the Step & Repeat X command begins.
Parameter	Description (refer to the diagram below and to “Example Illustrations of Step & Repeat Parameters” on page 101)																
Direction	The direction the tip moves along the XY axes. Select X(1) to give priority to the X axis or Y(2) to give priority to the Y axis.																
X Offset	The distance (in mm) between each workpiece in the X direction. Range: 0.1–100 (mm)																
Y Offset	The distance (in mm) between each workpiece in the Y direction. Range: 0.1–100 (mm)																
Columns (X)	The number of columns in the X direction. Range: 1–9999																
Rows (Y)	The number of rows in the Y direction. Range: 1–9999																
Path S(1)/N(2)	The path of pattern travel. Select 1 for an S-shaped pattern or 2 for an N-shaped pattern.																
Goto Label	The address where the Step & Repeat X command begins.																

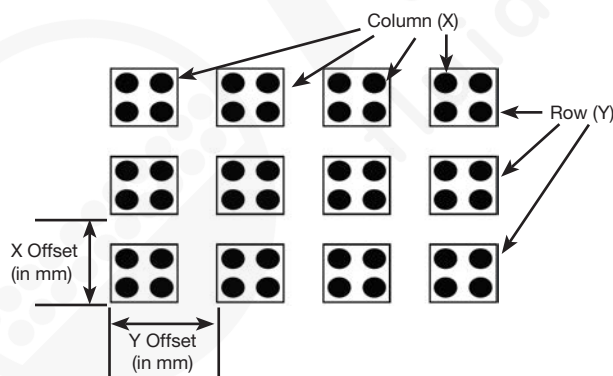
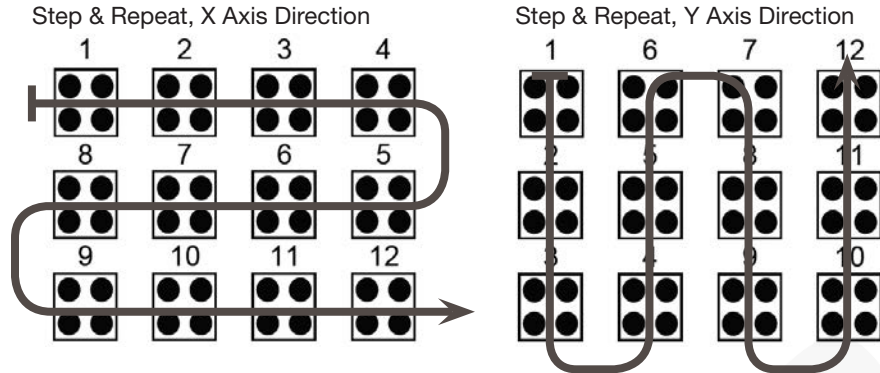

Diagram of the Step & Repeat 2D X Offset, Y Offset, Columns (X), and Rows (Y) Parameters

Appendix A, Type Menu Reference (continued)

12 Step & Repeat (continued)

Example Illustrations of Step & Repeat Parameters



Difference between the X and Y axis Direction parameter

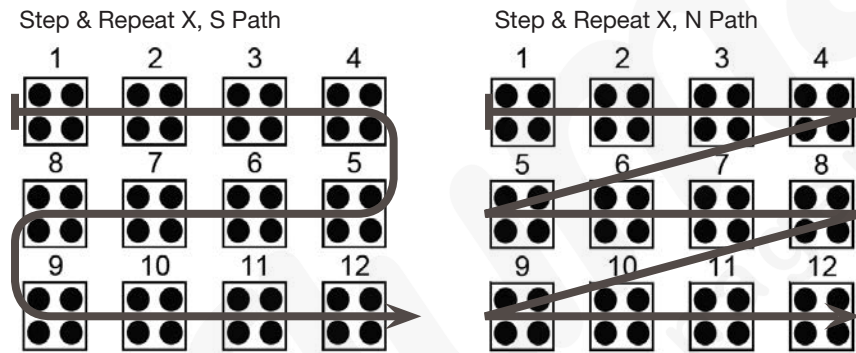

Difference between the S and N paths when the Direction is X

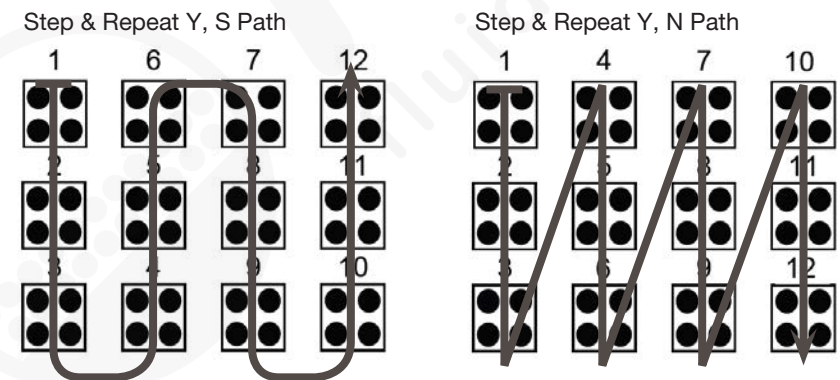

Difference between the S and N paths when the Direction is Y

Appendix A, Type Menu Reference (continued)

12 Step & Repeat 3D

```

Step & Repeat
-----
[F1] Step & Repeat 2D
[F2] Step & Repeat 3D
-----
  
```



```

Step & Repeat 3D          1/2
-----
Direction X(1)/Y(2):      1
X Offset:                 1.00 mm
Y Offset:                 1.00 mm
Z Offset:                 1.00 mm

[F1] OK [F2] Next
  
```

```

Step & Repeat 3D          2/2
-----
Column (X):              1
Row (Y):                 1
Tier (Z):                1
Path S(1)/N(2):          1
Goto Label:              1
[F1] OK [F2] Next
  
```

Key Press	Function																				
 > 	Enables the repeat of the dispensing pattern onto many identical workpieces that are mounted on a fixture plate and aligned in rows and columns.																				
	<table border="1"> <thead> <tr> <th>Parameter</th> <th>Description (refer to the diagram below and to “Example Illustrations of Step & Repeat Parameters” on page 101)</th> </tr> </thead> <tbody> <tr> <td>Direction</td> <td>The direction the tip moves along the XY axes. Select X(1) to give priority to the X axis or Y(2) to give priority to the Y axis.</td> </tr> <tr> <td>X Offset</td> <td>The distance (in mm) between each workpiece in the X direction. Range: 0.1–100 (mm)</td> </tr> <tr> <td>Y Offset</td> <td>The distance (in mm) between each workpiece in the Y direction. Range: 0.1–100 (mm)</td> </tr> <tr> <td>Z Offset</td> <td>The distance (in mm) between each workpiece tier in the Z direction. Range: 0.1–100 (mm)</td> </tr> <tr> <td>Columns (X)</td> <td>The number of columns in the X direction. Range: 1–9999</td> </tr> <tr> <td>Rows (Y)</td> <td>The number of rows in the Y direction. Range: 1–9999</td> </tr> <tr> <td>Tier (Z)</td> <td>The number of tiers in the Z direction: <ul style="list-style-type: none"> A positive Z value moves the tip down towards the work surface. A negative Z value moves the tip up away from the work surface. Range: 1–9999</td> </tr> <tr> <td>Path S(1)/N(2)</td> <td>The path of pattern travel. Select 1 for an S-shaped pattern or 2 for an N-shaped pattern.</td> </tr> <tr> <td>Goto Label</td> <td>The address where the Step & Repeat X command begins.</td> </tr> </tbody> </table>	Parameter	Description (refer to the diagram below and to “Example Illustrations of Step & Repeat Parameters” on page 101)	Direction	The direction the tip moves along the XY axes. Select X(1) to give priority to the X axis or Y(2) to give priority to the Y axis.	X Offset	The distance (in mm) between each workpiece in the X direction. Range: 0.1–100 (mm)	Y Offset	The distance (in mm) between each workpiece in the Y direction. Range: 0.1–100 (mm)	Z Offset	The distance (in mm) between each workpiece tier in the Z direction. Range: 0.1–100 (mm)	Columns (X)	The number of columns in the X direction. Range: 1–9999	Rows (Y)	The number of rows in the Y direction. Range: 1–9999	Tier (Z)	The number of tiers in the Z direction: <ul style="list-style-type: none"> A positive Z value moves the tip down towards the work surface. A negative Z value moves the tip up away from the work surface. Range: 1–9999	Path S(1)/N(2)	The path of pattern travel. Select 1 for an S-shaped pattern or 2 for an N-shaped pattern.	Goto Label	The address where the Step & Repeat X command begins.
Parameter	Description (refer to the diagram below and to “Example Illustrations of Step & Repeat Parameters” on page 101)																				
Direction	The direction the tip moves along the XY axes. Select X(1) to give priority to the X axis or Y(2) to give priority to the Y axis.																				
X Offset	The distance (in mm) between each workpiece in the X direction. Range: 0.1–100 (mm)																				
Y Offset	The distance (in mm) between each workpiece in the Y direction. Range: 0.1–100 (mm)																				
Z Offset	The distance (in mm) between each workpiece tier in the Z direction. Range: 0.1–100 (mm)																				
Columns (X)	The number of columns in the X direction. Range: 1–9999																				
Rows (Y)	The number of rows in the Y direction. Range: 1–9999																				
Tier (Z)	The number of tiers in the Z direction: <ul style="list-style-type: none"> A positive Z value moves the tip down towards the work surface. A negative Z value moves the tip up away from the work surface. Range: 1–9999																				
Path S(1)/N(2)	The path of pattern travel. Select 1 for an S-shaped pattern or 2 for an N-shaped pattern.																				
Goto Label	The address where the Step & Repeat X command begins.																				

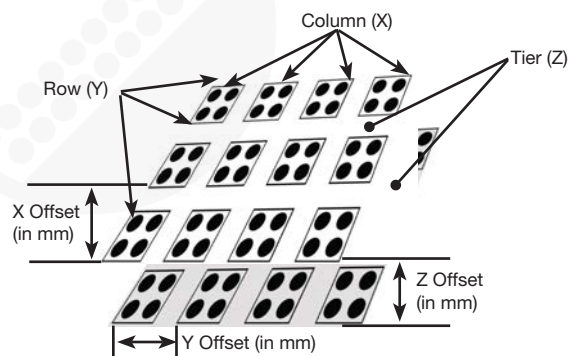
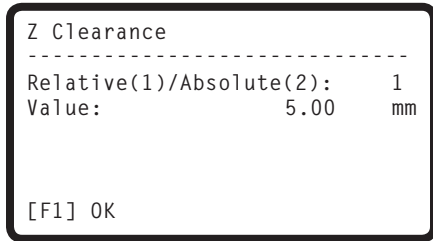



Diagram of the Step & Repeat 3D X Offset, Y Offset, Columns (X), Rows (Y), and Tier (Z) Parameters

Appendix A, Type Menu Reference (continued)

13 Z Clearance



Key Press	Function						
  > 6	<p>Specifies the height to which the dispensing tip raises after each dispense command. The purpose of Z Clearance is to raise the tip high enough so that it clears all obstacles as it moves from one point to another. If there are no obstacles between any of the points, a small Z-clearance value, such as 5 mm, can be used to minimize the program cycle time.</p> <p>Z Clearance is further defined as a relative value (0) or an absolute value (1) . When specified as a relative value, it is the distance the tip raises relative to the taught point location. When it is specified as an absolute value, it is the distance from the Z-axis zero position to which the tip raises regardless of the Z-axis value of the taught point location.</p> <p>Nordson EFD recommends inserting a Z Clearance command at the beginning of a program.</p> <table border="1"> <thead> <tr> <th>Parameter</th> <th>Description (see illustrations below)</th> </tr> </thead> <tbody> <tr> <td>Value</td> <td>The distance the tip raises after dispensing.</td> </tr> <tr> <td>Relative(1)/ Absolute(2)</td> <td>How the tip raises after dispensing: select 1 for relative or 2 for absolute.</td> </tr> </tbody> </table>	Parameter	Description (see illustrations below)	Value	The distance the tip raises after dispensing.	Relative(1)/ Absolute(2)	How the tip raises after dispensing: select 1 for relative or 2 for absolute.
Parameter	Description (see illustrations below)						
Value	The distance the tip raises after dispensing.						
Relative(1)/ Absolute(2)	How the tip raises after dispensing: select 1 for relative or 2 for absolute.						

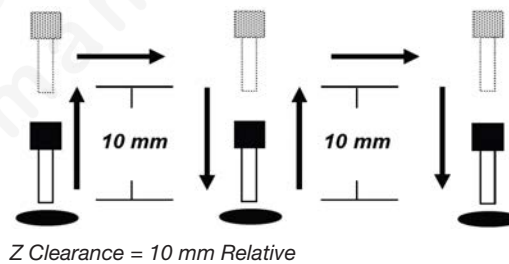
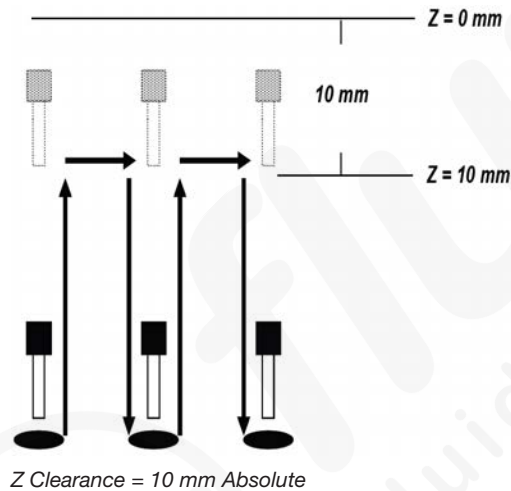



Appendix A, Type Menu Reference (continued)

14 Loop

```

Loop
-----
Label:          1
Count:         1

[F1] OK
  
```

Key Press	Function						
   Type >	Executes a group of commands for the specified number of times (Count).						
	<table border="1"> <thead> <tr> <th>Parameter</th> <th>Description</th> </tr> </thead> <tbody> <tr> <td>Label</td> <td>The address number the program jumps to. The jump-to address must occur before the current address.</td> </tr> <tr> <td>Count</td> <td>The number of times to execute the loop. Range: 1-9999</td> </tr> </tbody> </table>	Parameter	Description	Label	The address number the program jumps to. The jump-to address must occur before the current address.	Count	The number of times to execute the loop. Range: 1-9999
Parameter	Description						
Label	The address number the program jumps to. The jump-to address must occur before the current address.						
Count	The number of times to execute the loop. Range: 1-9999						



15 Dispense Port

```

Dispense Port
-----
Port: 0.3.5.7

Default: 0   Range: 0-8
Multi-out ex: 0.1.2

[F1] OK
  
```

Key Press	Function
   Type >	Sets the output port for the dispense valve signal. Use this command at the beginning of a program to set the dispense port or immediately before a dispense command. If the system includes multiple valves, you can specify multiple dispense ports, as shown in the example above (Multi-out ex: 0.1.2). Default: 0 Range: 0-8

Appendix A, Type Menu Reference (continued)

16 Call Pattern

```



Call Pattern 1/2
-----
X: 130.93 mm
Y: 37.39 mm
Z: 45.54 mm

[F1] OK [F2] Next [F3] Current
    
```

```

Call Pattern 2/2
-----
Label: 1

[F1] OK [F2] Next
    
```

Key Press	Function
 >  	<p>Causes the system to dispense in a pattern that is like another pattern in the program, but at the location in the program where the Call Pattern command occurs. The called pattern must have a Label assigned to it. The system stops dispensing the called pattern when it reaches an End Pattern command.</p> <p>Example of a program with a Call Pattern command:</p> <pre> 0001 Call Pattern Label 1 0002 Call Pattern Label 1 0003 End Program 0004 EMPTY 0005 Label 1 0006 Line Start 10.0,1 0007 Line End 0008 Line Start 10.0,1 0009 Line End 0010 Dispense Dot 0.100 0011 Dispense Dot 0.100 0012 Dispense Dot 0.100 0013 Dispense Dot 0.100 0014 Dispense Dot 0.100 0015 End Pattern </pre>

Programmed Pattern

The dispense points that are defined under a Label command in a dispense program.

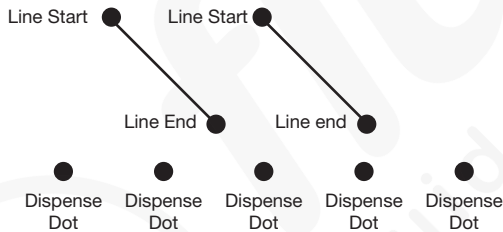

Call Pattern 1

The pattern is executed at the specified locations using the Call Pattern command.

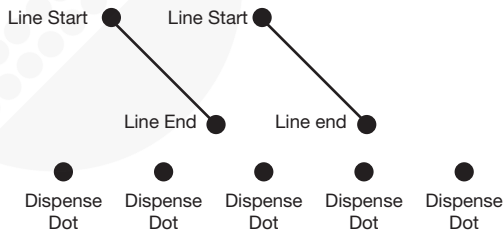

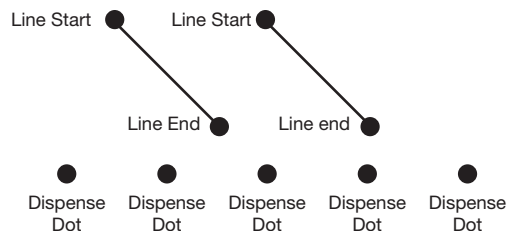

Call Pattern 2



Example Illustration of the Call Pattern command

Appendix A, Type Menu Reference (continued)

17 End Pattern

Key Press	Function
 >  	Used in tandem with Call Pattern to return the program to the address that occurs just after a Call Pattern command.



18 Call Subroutine

```



Call Subroutine
-----
Label:                1

[F1] OK

```

Key Press	Function
 >  	<p>Causes the program to jump to a set of commands (called a subroutine) located after the end of a program. The first command in the subroutine must be a Label command (shown below as line 0006). The program jumps to the specified address (0006 in this example) and then executes the commands after that address. When the End Subroutine command is reached, the program returns to the address that immediately follows the Call Subroutine command (0004 in this example).</p> <p>NOTE: For example, the Call Subroutine command could be used for a tip cleaning routine.</p> <p>Example of a program with a Call Subroutine command:</p> <pre> 0001 Line Start 10.0,1 0002 Line End 0003 Call Subroutine Label 1 0004 End Program 0005 EMPTY 0006 Label 1 0007 Dispense Dot 0.100 0008 Dispense Dot 0.100 0009 Dispense Dot 0.100 0010 End Subroutine </pre>

19 End Subroutine

Key Press	Function
 >  	Used in tandem with Call Subroutine to return the program to the address that occurs just after a Call Subroutine command.



Appendix A, Type Menu Reference (continued)

20 Call Program

```

Call Program
-----
Program Number:    1

[F1] OK
  
```

Key Press	Function
 >  	Executes an existing program number within the current program. If no program exists for the program number being called, an error occurs.

21 Set I/O

```

Set I/O
-----
1 Input
2 Output
Select: _

[F1] OK
  
```

```



Set I/O (Input)
-----
Port 1-8:                1
Off(0)/On(1):           1
Goto Label:              1

[F1] OK
  
```

```

Set I/O (Output)
-----
Port 1-8:                1
Off(0)/On(1):           0

[F1] OK
  
```

Key Press	Function	
 >  	Sets the value of an output signal or checks the status of an input signal. Refer to "I/O Port" on page 89 for input / output port technical data.	
	Setting	Description
	1 Input	Enter the input port number (1–8), the input status (1 = ON or 0 = OFF), and the address (Goto Label) for the program to go to when that input status occurs.
	2 Output	Enter the output port number (1–8) and whether the output should be turned ON or OFF (1 = ON or 0 = OFF).

Appendix A, Type Menu Reference (continued)

22 Fill Area



```

Fill Area                               1/2
-----
Fill Type:                               2
1 Rectangle                               5 Circle Out
2 Rectangle In                             6 Polygon In
3 Rectangle Out                           7 Polygon Out
4 Circle In
[F1] OK [F2] Next
  
```

```

Fill Area                               2/2
-----
Width:                                   1.29 mm
Band:                                    13.17 mm

[F1] OK [F2] Next
  
```

Key Press	Function								
 > 	Fills a defined area in a specific way using the specified Width and Band parameters. Refer to “Example Illustrations of Fill Area Parameters” on page 109.								
	<table border="1"> <thead> <tr> <th>Parameter</th> <th>Description (refer to “Example Illustrations of Fill Area Parameters” on page 109)</th> </tr> </thead> <tbody> <tr> <td>Fill Type</td> <td>1 Rectangle 2 Rectangle In 3 Rectangle Out 4 Circle In 5 Circle Out 6 Polygon In 7 Polygon Out</td> </tr> <tr> <td>Width</td> <td>The distance (in mm) between the fill dispense lines. Range: 0–500 (mm)</td> </tr> <tr> <td>Band</td> <td>The width (in mm) of the fill area. Range: 0–500 (mm) NOTE: Band distance is ignored for rectangle Fill Type 1 because this function is not supported.</td> </tr> </tbody> </table>	Parameter	Description (refer to “Example Illustrations of Fill Area Parameters” on page 109)	Fill Type	1 Rectangle 2 Rectangle In 3 Rectangle Out 4 Circle In 5 Circle Out 6 Polygon In 7 Polygon Out	Width	The distance (in mm) between the fill dispense lines. Range: 0–500 (mm)	Band	The width (in mm) of the fill area. Range: 0–500 (mm) NOTE: Band distance is ignored for rectangle Fill Type 1 because this function is not supported.
Parameter	Description (refer to “Example Illustrations of Fill Area Parameters” on page 109)								
Fill Type	1 Rectangle 2 Rectangle In 3 Rectangle Out 4 Circle In 5 Circle Out 6 Polygon In 7 Polygon Out								
Width	The distance (in mm) between the fill dispense lines. Range: 0–500 (mm)								
Band	The width (in mm) of the fill area. Range: 0–500 (mm) NOTE: Band distance is ignored for rectangle Fill Type 1 because this function is not supported.								

Appendix A, Type Menu Reference (continued)

Example Illustrations of Fill Area Parameters

Fill Area Type 1. Rectangle

This command fills the defined area by passing the tip back and forth (in an S-shaped path) at the specified Width. After entering a Fill Area Rectangle command, enter a Line Start point at the top left corner of the area to be filled and a Line End point at the bottom right corner of that area.

NOTES:

- Use Polygon In or Polygon Out for a rotated square shape.
- Band distance is ignored for the Rectangle fill type because this function is not supported.

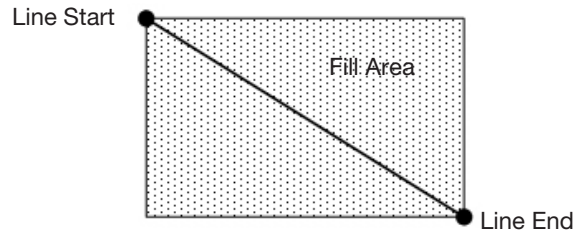

EXAMPLE:

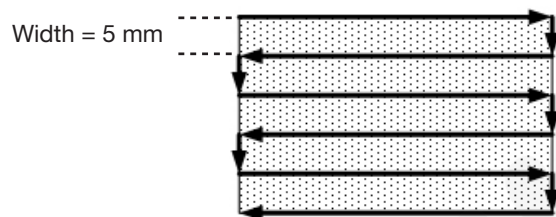

Rectangle when Width = 5

Fill Area Type 2. Rectangle In

This command fills the defined area by moving the tip along a square, spiral-shaped path from the outside of the rectangle to the center. After entering a Fill Area Rectangle In command, enter a Line Start point at the top left corner of the area to be filled and a Line End point at the bottom right corner of that area.

NOTE: Use Polygon In or Polygon Out for a rotated square shape.

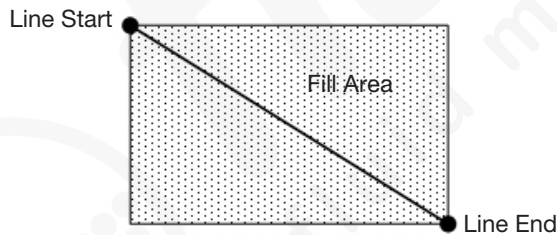

EXAMPLES:

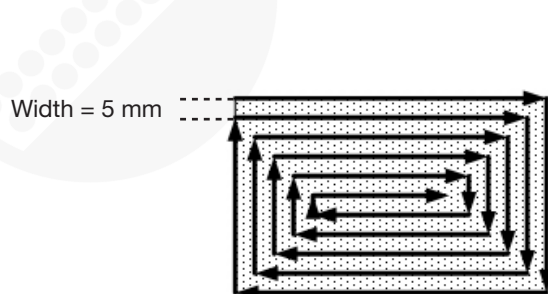

Rectangle In when Width = 5 and Band = 0

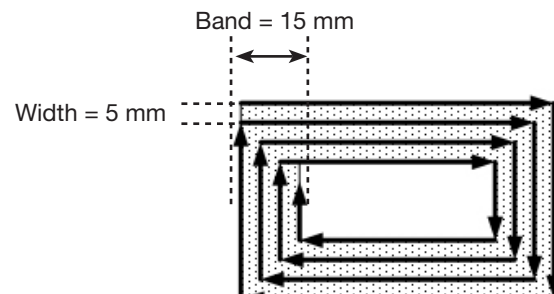

Rectangle In when Width = 5 and Band = 15

Appendix A, Type Menu Reference (continued)

Fill Area Type 3. Rectangle Out

This command fills a rectangular area by moving the tip along a square, spiral-shaped path from the center of the rectangle to the outside. After entering a Fill Area Rectangle Out command, enter Line Start point at the top left corner of the area to be filled and a Line End point at the bottom right corner of that area.

NOTE: Use Polygon In or Polygon Out for a rotated square shape.

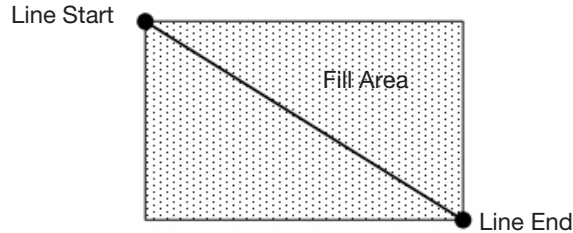

Rectangle Out when Width = 5 mm

EXAMPLES:

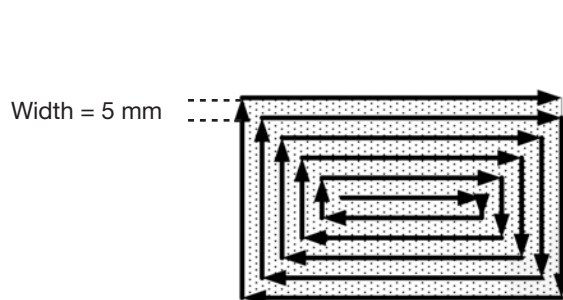

Rectangle Out when Width = 5 and Band = 0

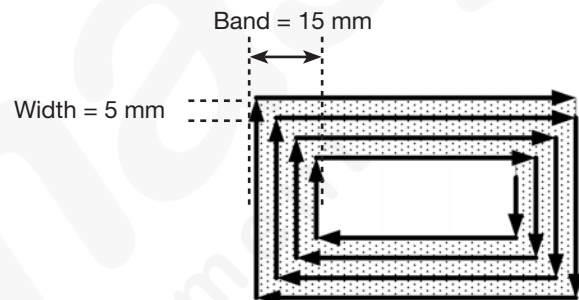

Rectangle Out when Width = 5 and Band = 15

Fill Area Type 4. Circle In

This command fills the defined area by moving the tip along a spiral path from the outside of the circle to the center. After entering a Fill Area Circle In command, jog the tip to a point on the outside limit of the circle to be filled and enter that location as a Line Start point. Then jog the tip directly across to the center of the circle and enter that location as a Line End point.

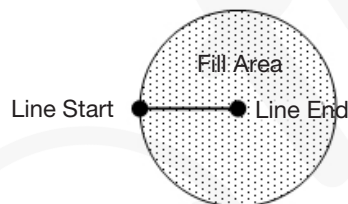

EXAMPLES:

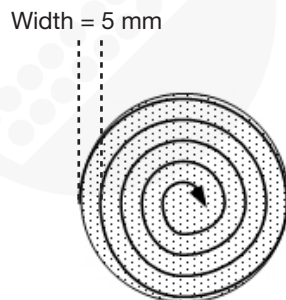

Circle In when Width = 5 and Band = 0

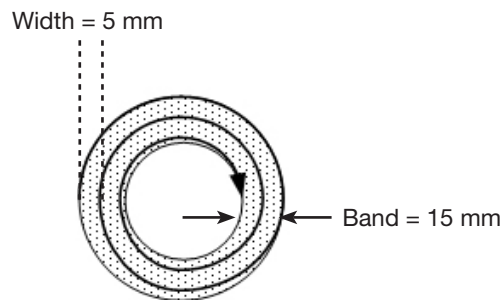

Circle In when Width = 5 and Band = 15

Appendix A, Type Menu Reference (continued)

Fill Area Type 5. Circle Out

This command fills a defined circular band area by moving the tip along a spiral path from the outside of the circle to the center. After entering a Fill Area Circle Out command, jog the tip to a point on the outside limit of the circle to be filled and enter that location as a Line Start point. Then jog the tip directly across to the center of the circle and enter that location as a Line End point.

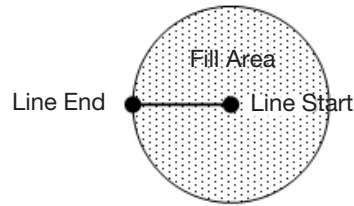

EXAMPLES:

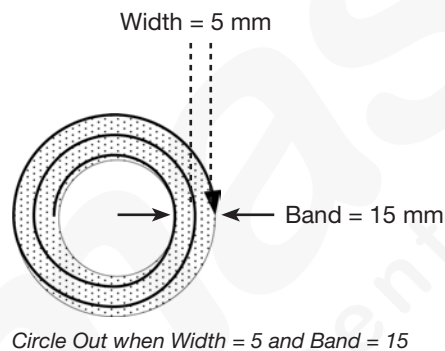
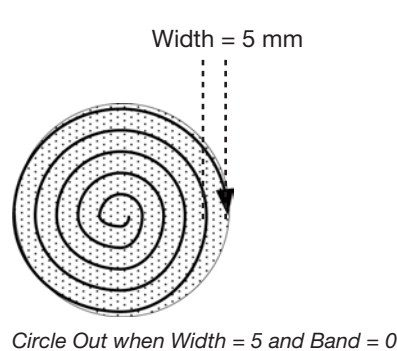

Fill Area Type 6. Polygon In (Outer to Inner)

This command fills the defined area by moving the tip along a spiral-shaped path from the outside of the polygon shape to the center. After entering a Polygon In command, enter a Line Start point at the first corner of the area to be filled, a Line Passing point for each corner after Line Start, and a Line End point for the last corner of the area.

NOTE: Use Polygon In or Polygon Out for a rotated square shape.

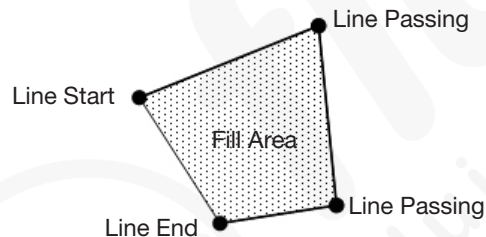

EXAMPLES:

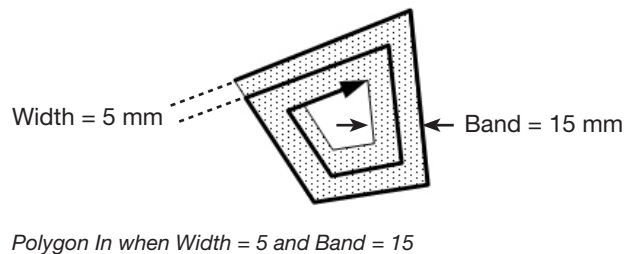
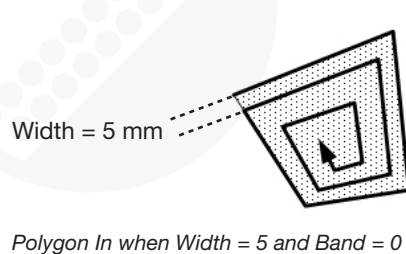

Appendix A, Type Menu Reference (continued)

Fill Area Type 7. Polygon Out (Inner to Outer)

This command fills the defined area by moving the tip along a spiral-shaped path from the inside of the polygon shape to the outer edge. After entering a Polygon Out command, enter a Line Start point at the first corner of the area to be filled, a Line Passing point for each corner after Line Start, and a Line End point for the last corner of the area.

NOTE: Use Polygon In or Polygon Out for a rotated square shape.

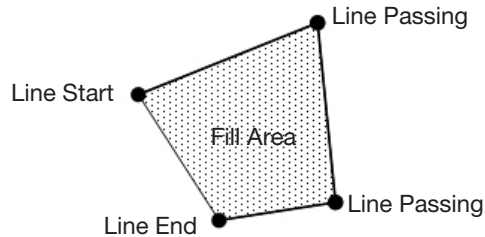

EXAMPLES:

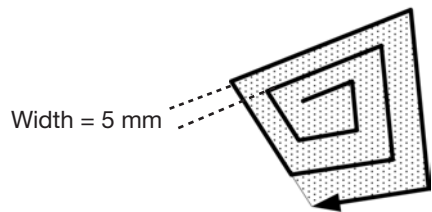

Polygon Out when Width = 5 and Band = 0

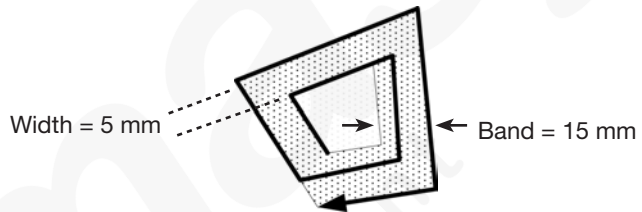



Polygon Out when Width = 5 and Band = 15

23 Acceleration

Acceleration

Value: 50 mm/s²

[F1] OK

Key Press	Function
 >  	Controls the acceleration of the robot axes from point to point along a continuous path. This command is useful for creating sharp corners in a line dispense pattern. Default (recommended): 50 (mm/s ²) Range: 20–500 (mm/s ²)

Appendix A, Type Menu Reference (continued)

24 Dummy Point

```



Dummy Point          1/2
-----
X:                   130.93 mm
Y:                   37.39 mm
Z:                   45.54 mm

[F1] OK [F2] Next [F3] Current
  
```

```

Dummy Point          2/2
-----
Speed:               10.0 mm/s

[F1] OK [F2] Next
  
```



Key Press	Function
 Type >  	<p>Registers the current XYZ location as a Dummy Point. The dispensing tip passes through this point. A Dummy Point is useful for avoiding obstacles on the workpiece.</p> <ul style="list-style-type: none"> Press F1 to set the Dummy Point at the displayed coordinates Press F3 to set the Dummy Point at the current dispensing tip location, updating the XYZ coordinates accordingly. <p>SPEED sets the speed at which the robot travels as it moves through the Dummy Point. Range: 0–500 (mm/s)</p>

25 Wait Time

```

Wait Time
-----
Value:               1.0 s

[F1] OK
  
```



Key Press	Function
 Type >  	<p>Adds a time delay at the current XYZ location. When this command occurs, the system stops dispensing and waits for the specified Wait Time Value. Range: 0–99999 (s)</p>

26 Stop Point

```



Stop Point
-----
X:                   130.93 mm
Y:                   37.39 mm
Z:                   45.54 mm

[F1] OK [F3] Current
  
```

Key Press	Function
 Type >  	<p>Registers a Stop Point at the current XYZ location. When this command occurs, the dispensing tip moves to the registered location, pauses the system, and keeps the system paused until the START button is pressed.</p> <ul style="list-style-type: none"> Press F1 to set the Stop Point at the displayed coordinates. Press F3 to set the Stop Point at the current dispensing tip location, updating the XYZ coordinates accordingly.



Appendix A, Type Menu Reference (continued)

27 Park Position

Key Press	Function
 >  	Moves the dispensing tip to the registered location, pauses the system, and keeps the system paused until the START button is pressed.

28 Height Sensor

```
[Height Sensor]
01 Setup
02 Sensor Position
03 Initial Height Detect
04 Offset Program
```

Key Press	Function
 >  	<p>Measures the height of an object on a workpiece where a dispense dot is to be placed; the measured data is then used to adjust dispensing accordingly for any height changes between workpieces.</p> <p>NOTE: For this functionality, the optional height sensor must be installed and set up. Refer to "Appendix D, Height Sensor Setup and Use" on page 130 for all information related to the height sensor.</p>

Appendix B, RS-232 Communication Protocol

You can perform some robot operations remotely through a personal computer (PC) or programmable logic controller (PLC).

Setting Up the System for Remote Operation

1. Connect a DB9 female straight cable to (1) the RS232 port on the back of the robot and (2) to the PC/PLC.

NOTE: If the PC does not have an on-board serial port, use a USB-to-serial converter with the DB9 cable. Refer to “Pre-Configured Output Cables” on page 80 for part numbers.

2. Enable Remote Command under the Setup menu. Refer to “Enabling or Disabling Remote Communication” below.
3. Refer to the following additional information also provided in this section:
 - “Communication Specifications” on page 116
 - “Commands” on page 116

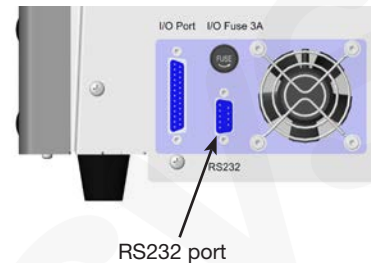

Enabling or Disabling Remote Communication

#	Key Press	Step	Teach Pendant Display
1		<ul style="list-style-type: none"> • Press F1. • MOVE UP / DOWN to TEACH/RUN. • Press ENTER. • Press HOME. If prompted, enter a password. 	<pre>[PROGRAM MENU] 1/1 01*Teach/Run 02 Program List 03 Reset Counter 04 Program Offset 05 Needle Adjust 06 Auto Needle Adjust</pre>
2		<ul style="list-style-type: none"> • Press SETUP. • MOVE UP / DOWN to REMOTE COMMAND. • Press ENTER. 	<pre>[SETUP] 3/3 15 Measurement Unit 16 Password Setup 17*Remote Command 18 Height Sensor 19 Language 20 System Information</pre>
3		<ul style="list-style-type: none"> • Press 1 ENABLE to enable remote communication. • Press 2 DISABLE to disable remote communication. • Press F1 to save or exit. 	<pre>Remote Command Disable ----- 1 Enable 2 Disable Select: _ [F1] OK</pre>

Appendix B, RS-232 Communication Protocol (continued)

Communication Specifications

- Baud rate 115200
- Data bit 8
- Parity None
- Stop bits 1
- Flow control None

Commands

- Commands sent are terminated with a carriage return (0x0D). The robot evaluates each received command and then sends a response.
- Responses are preceded by the pound symbol (#).

Command Description	Function	Command Sequence	Response
Simulate START button	Use to start or pause the robot	:S<CR>	Not applicable
Change program number	Use to open a different program by specifying the number	:Pxx<CR> where xx = the program number (1–99) to open	#xx<CR> where xx = the program number opened (1–99)
Query program number	Use to determine the currently open program number	?P<CR>	#xx<CR> where xx = the currently open program number (1–99)
Query machine status	Use to determine the operating status of the robot	?M<CR>	#xx<CR> where xx = a decimal number to convert to a binary number; refer to the table below (“Query Machine Status Response Values”)

Query Machine Status Response Values

Bit	7	6	5	4	3	2	1	0
Description	Reserved	Wait Start	Homing	Reserved	Emergency	Running	Reserved	Teach (1) Run (0)

Example Responses from the Robot

Response from Robot	Response Converted to Binary Number	Meaning of Response
#82	0101 0010	The robot is Homing in the Run Mode.
#19	0001 0011	The robot is Idle in the Teach Mode.
#7	0000 0111	The robot is Running in the Teach Mode.
#22	0001 0110	The robot is Running in the Run Mode.

Appendix C, DXF File Import Using TeachMotion DXF

TeachMotion™ DXF is a software utility designed to import DXF files, thus simplifying dispensing program development. Importing a DXF file into the TeachMotion DXF software creates a dispensing program that includes all the commands necessary to replicate the user-selected points, lines, arcs, and circles of a DXF file.

This software can also be used to create and modify the dispense programs stored on the Teach Pendant, allowing you to conveniently manage all dispense programs through a personal computer (PC). This appendix provides an overview of the TeachMotion DXF software and the procedures for using the software to import DXF files.

Installing TeachMotion DXF and Connecting to the Robot

1. Go to www.nordsonefd.com/TeachMotion to request the TeachMotionDXF software.
2. Install the TeachMotion DXF software on a PC.
3. Connect a DB9 female straight cable to (1) the RS232 port on the back of the robot and (2) to the PC/PLC.

NOTE: If the PC does not have an on-board serial port, use a USB-to-serial converter with the DB9 cable. Refer to “Pre-Configured Output Cables” on page 80 for part numbers.

4. Switch on the robot.
5. On the Teach Pendant, press F1 > TEACH/RUN to enter the Teach Mode.

NOTE: The Teach Pendant cable should already be connected to the Teach Pendant port on the front of the robot.

6. Disable REMOTE COMMAND under the Setup menu. Refer to “Enabling or Disabling Remote Communication” on page 115.
7. On the PC, double-click the TeachMotion DXF icon. The software automatically connects to the robot.

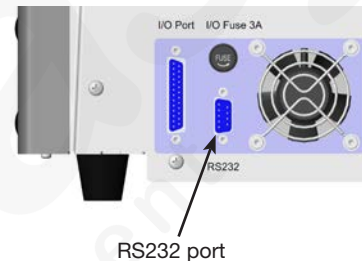

RS232 port

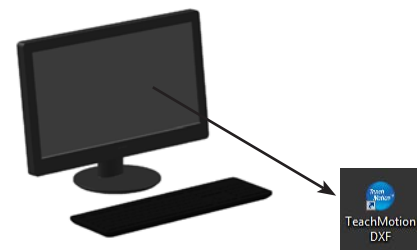

Overview of the TeachMotion DXF Software



When the TeachMotion DXF software is opened, it automatically connects to the robot. If the system is not connected as described under “Installing TeachMotion DXF and Connecting to the Robot” on page 117, a window appears to indicate that the system is unable to connect and the software then runs in the offline mode.

The software includes three primary screens: Program, Option, and DXF. The software opens at the Program screen, shown below.

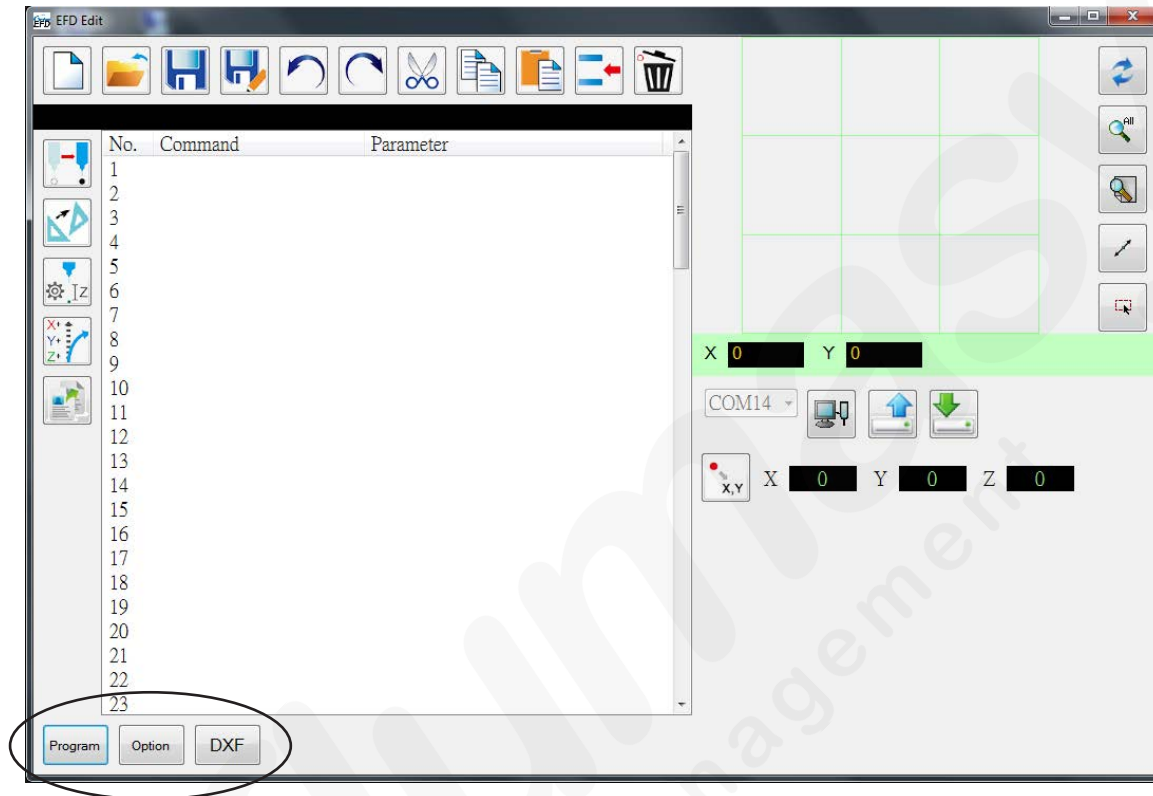

Tab Name	Tab Color When Selected	Function
Program		Opens the program screen. This screen is used to modify the command list that is generated after file import and to view a representation of the resulting dispense pattern.
Option		Opens the Option screen. This screen is used to set up system-level settings.
DXF		Opens the DXF screen. This screen is used to import a DXF file, select the desired points and lines, and generate the initial set of dispense commands.

Program Screen and Icons

The Program screen is used to modify the command list that is generated after file import and to view a representation of the resulting dispense pattern.

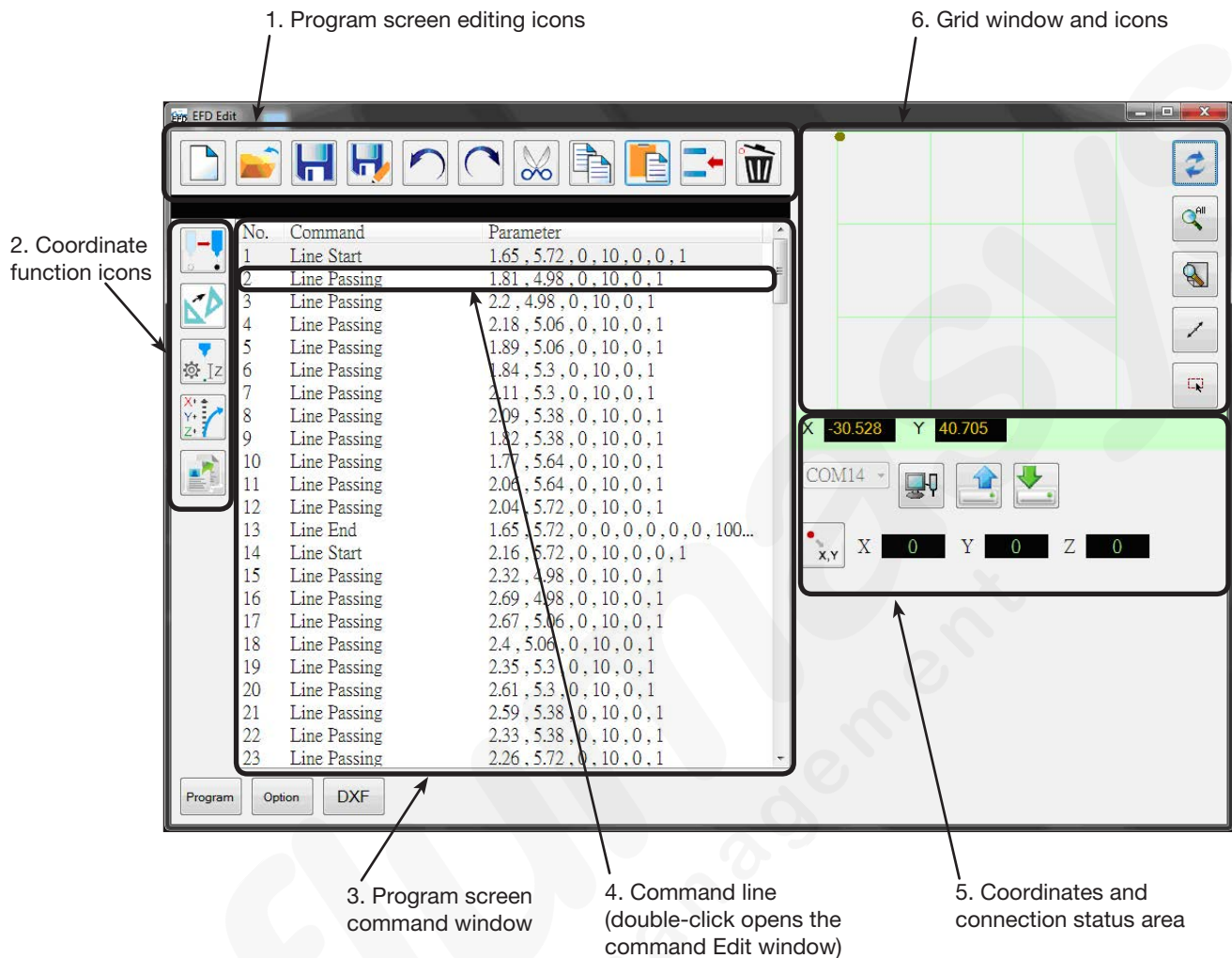

1. Program Screen Editing Icons

The Program screen editing icons are used to open program files and to manipulate commands within a program file.

Icon Name	Icon	Function
A New File		Creates a new file
Open a File		Opens a file
Save		Saves the open file
Save as		Saves the open file as a new file name
Undo		Undoes the last command
Redo		Restores the last Undo action

Icon Name	Icon	Function
Cut		Cuts a selection
Copy		Copies a selection
Paste		Pastes a selection
Insert		Inserts a command
Delete		Deletes the current command

Program Screen and Icons (continued)

2. Coordinate Function Icons

The coordinate function icons are used to move the tip and to manipulate the coordinates or parameters within commands.

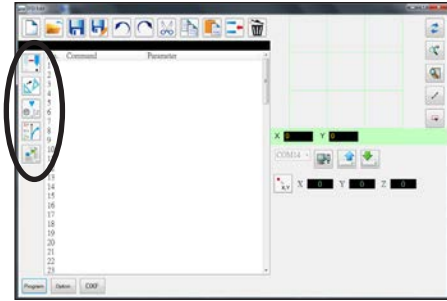

Icon Name	Icon	Function
Touch Move		Moves the tip to the XYZ location of a selected command (if the command has a location value)
Transform		Aligns the program points of an uploaded DXF drawing with their actual locations on a workpiece
Change Z Value		Changes the Z value in a command or in a list of selected commands in a program (mainly used to fine-tune and adjust the dispensing gap)
Offset		Changes or moves all program points if the placement of a workpiece was changed
Paste Parameter		Pastes all command parameters copied from the Edit window NOTE: The Edit window opens when you double-click on a command to view or change the command parameters.

3. Program Screen Command Window

The Program screen command window shows the dispense commands generated after DXF import using the DXF screen.

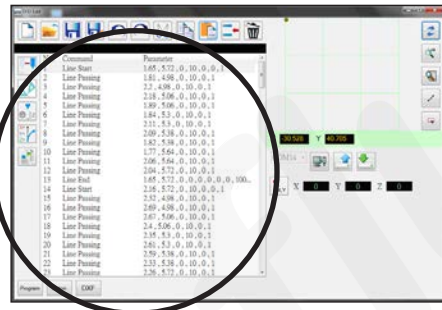

4. Command Edit Window

The command Edit window opens when you double-click on a command line. On this screen, commands are selected using the drop down menu.

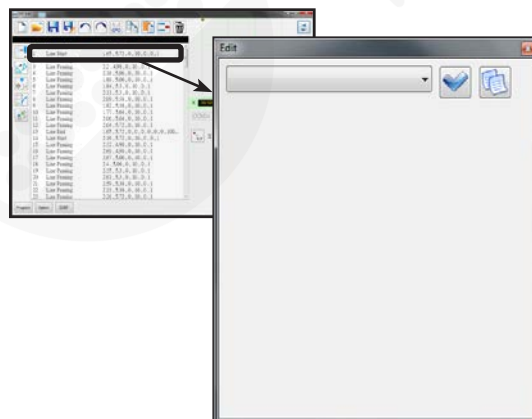

Icon Name	Icon	Function
OK		Saves the command parameter values entered in the Edit window
Copy Parameter		Copies all command parameter values (not coordinate values) in the Edit window. Copied parameters can be pasted to another command line (of the same command) using Paste Parameter on the Program screen.

Program Screen and Icons (continued)

5. Coordinates and Connection Status Area

The coordinates fields show the current coordinates of the dispensing tip when you click the Location icon. The port selection drop-down menu and icons are used to connect or disconnect the system to a PC and to transfer programs.

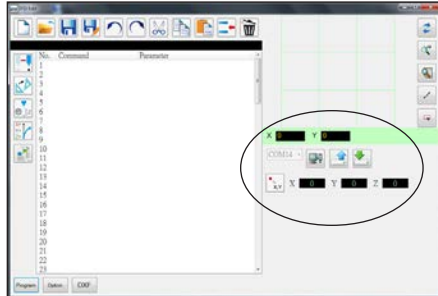

Item	Image	Function
Port Selection drop-down menu		Selects the connection port
Connect		Connects or disconnects the robot to or from the PC
Upload		Uploads a dispense program to the robot
Download		Downloads a dispense program from the robot
Location		Queries the robot for the coordinates of the current location of the tip

6. Grid Window and Icons

The grid window shows the points and lines selected using the DXF screen.

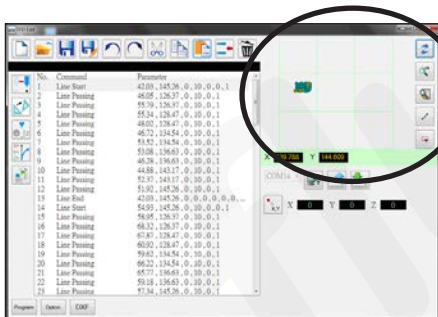

Icon Name	Icon	Function
Refresh		Refreshes the grid window
See all		Shows all the programmed points
Magnify		Magnifies an area of the grid window
Reverse line		Reverses the direction of the programmed points
Select entity		Selects a group of points

Option Screen

The Option screen is used to set up the system-level settings the system uses when the TeachMotion DXF software is running.

The screenshot shows the 'EFD Edit' window with the 'Option' screen selected. The interface includes the following fields and controls:

- Program Label:** A text input field.
- Speed (mm/s):** Input fields for X (300), Y (300), and Z (50).
- Limit (mm):** Input fields for X (300), Y (300), and Z (100).
- Park position (mm):** Input fields for X (0), Y (0), and Z (0).
- Tip Adjust (mm):** Input fields for X (0), Y (0), and Z (0).
- Auto Purge(s):** Input fields for Wait Time (0) and Purge Time (0).
- Version:** A text field showing '1.01G'.
- Buttons:** 'Program', 'Option' (highlighted), and 'DXF'.
- Other controls:** A 'Download' button, a language dropdown menu set to 'English', and radio buttons for '3 axis' (selected) and '4 axis'.

Item	Description
Program Label	Names the set of commands generated during DXF import. This information transfers to the Program Name field on the Teach Pendant.
Speed (mm/s)	Sets the speed of the of X and Y axis movement: <ul style="list-style-type: none"> • Maximum XY speed: 800 (mm/s) • Default: 100 (mm/s)
Park Position	Sets the Park Position coordinates. You can enter these values or download them from the robot. NOTE: Refer to “Park Position” on page 37 for more information.
Tip Adjust (mm)	Sets the coordinates of the calibration point. You can enter these values or download them from the robot. NOTES: <ul style="list-style-type: none"> • Tip Adjust is available only when 3 AXIS is selected. • Refer to “Calibrating the Tip Height” on page 72 for more information.
Limit (mm)	Do not modify these settings.
Axis	Specifies the number of axes for the robot currently connected to the PC.
Auto Purge(s)	Sets the Auto Purge parameters. You can enter these values or download them from the robot. NOTE: Refer to “Auto Purge” on page 41 for more information.





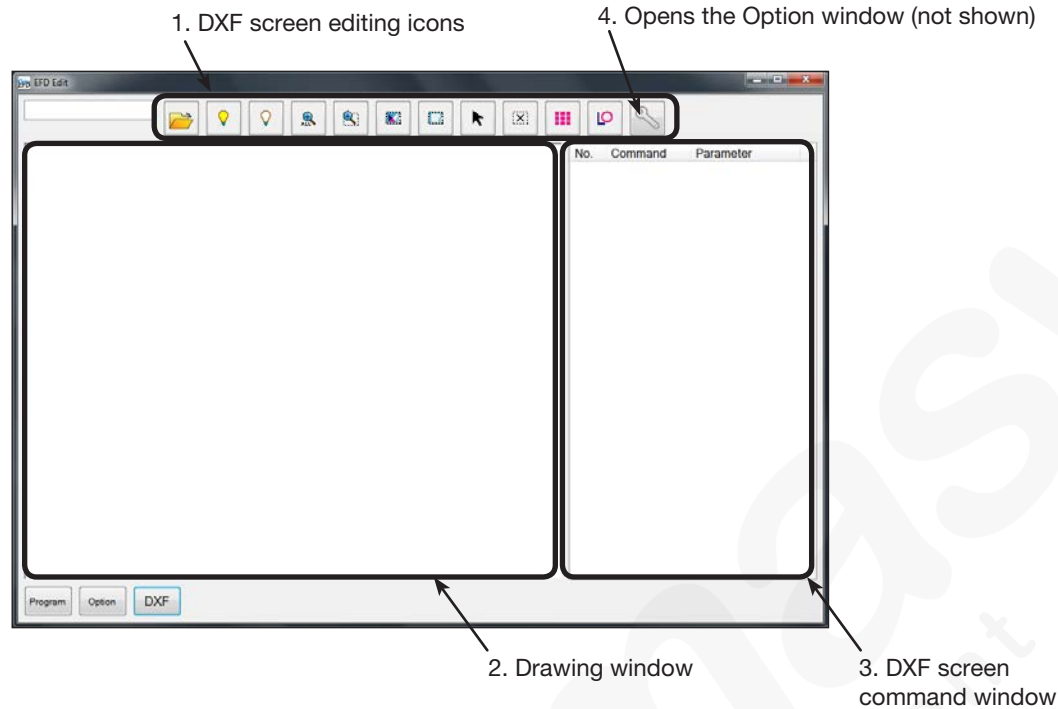

DXF Screen and Icons





The DXF screen is used to import a DXF file, select the desired points and lines, and generate the initial set of dispense commands.



1. DXF Screen Editing Icons

The DXF screen editing icons are used to manipulate the points of an imported DXF file.

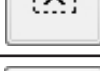
Icon Name	Icon	Function
Open a File		Opens a file
Show All Layers		Shows all layers of the open DXF file
Hide All Layers		Hides all layers of the open DXF file
See All		Compresses or resizes the display so that all points of the open DXF file are displayed in the viewing area of the screen
Zoom		Zooms to the selected area
Select All		Selects all the points in the DXF file

Icon Name	Icon	Function
Select		Selects only the points within the area of the of rectangle
Click to Select		Selects one element
Cancel Select		Cancels any selections
Point Dispense		Inserts Dispense Dot commands for all the selected points on an imported DXF image
Line Dispense		Inserts line dispense commands for all the selected shapes on an imported DXF image
Option		Opens the DXF screen Option window

DXF Screen and Icons (continued)

2. DXF Screen Drawing Window

After a DXF is imported, it appears in the DXF screen drawing window so you can select the drawing elements you want to include in the dispense program.

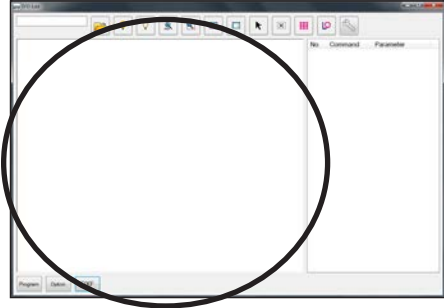

3. DXF Screen Command Window

Once the elements are selected and then either the Point Dispense or the Line Dispense icon is clicked, the pattern information is converted into commands with coordinates. The commands are shown in the DXF screen command window.

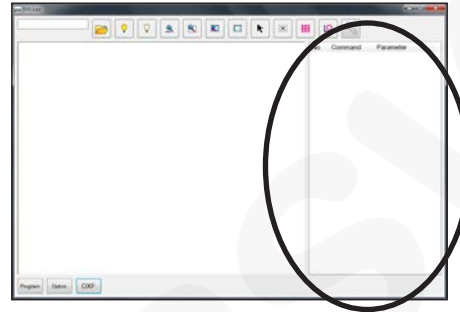

4. DXF Screen Option Window



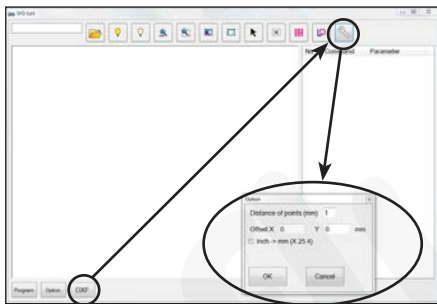



The DXF screen Option window is used to customize how a DXF file imports, thus improving the subsequent imported result. Refer to "Modifying the DXF Import Options" on page 125 for the procedure for using this screen to improve DXF import results.

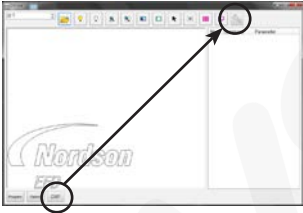
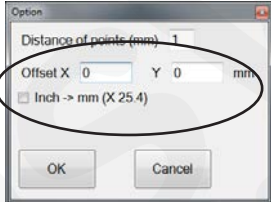
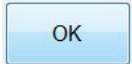

Item	Description
Distance of points (mm)	Specifies the distance between any two points on a curve when the curve is converted to coordinates. EXAMPLE: When this value is set to 1 and a 10-mm long curve is converted to commands, the result will be a series of Line Start, Line Passing, and Line End commands that will produce a curve with a total of 11 points.
Offset X, Y	After you generate program commands for an imported file (done by clicking the Point Dispense or Line Dispense icon), the resulting XY values may be a negative number. This causes the imported points to display off the grid window. To resolve this issue, you can enter X and / or Y values in these offset fields to cause the imported XY values to change to positive values. EXAMPLE: If an imported XY value is -150, -150, 0, enter 200 for Offset X and 200 for Offset Y, click OK and then click the Point Dispense or Line Dispense icon to refresh the values. The new values will be 50, 50, 0 and the points will be visible on the grid window on the Program screen.
Inch -> mm (X 25.4)	Causes the system to convert inches to millimeters upon DXF file import. EXAMPLE: If the source DXF has the length units set to inches, check this box to convert the drawing from inches to millimeters when it is imported.

Modifying the DXF Import Options

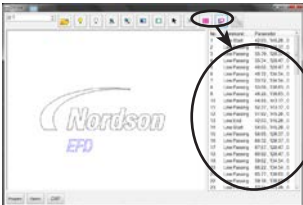
If the source DXF file is not importing cleanly, follow this procedure to update the DXF import options to improve the imported result.







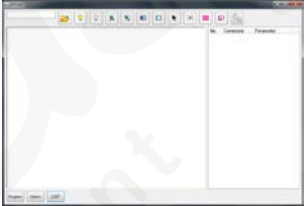

#	Click	Step	Reference Image
1	 > 	<ul style="list-style-type: none"> Click DXF and then click OPTION. The DXF Option window appears. 	
2	—	<ul style="list-style-type: none"> Update the following DXF import options as needed: <ul style="list-style-type: none"> For DISTANCE OF POINTS (MM), enter a value in mm to specify the distance between any two points on a curve. For OFFSET X and Y, enter values in mm to shift the elements of the DXF file upon import. For INCH > MM, click the checkbox to convert inches to millimeters upon import (required only if the source DXF file drawing units are in inches). <p>NOTE: Refer to “4. DXF Screen Option Window” on page 124 for more detailed information on the DXF screen Option settings.</p>	
3		<ul style="list-style-type: none"> Click OK to save the settings. Continue to the next step to update a DXF that you have already imported, or go to step 5. 	—
4	 or 	<ul style="list-style-type: none"> (If the DXF is already imported) Click POINT DISPENSE or LINE DISPENSE to update the dispense pattern coordinates. 	
5		<ul style="list-style-type: none"> Click PROGRAM to return to the Program screen. Continue to “Importing a DXF File” on page 126 to import a DXF using these settings. 	

Importing a DXF File

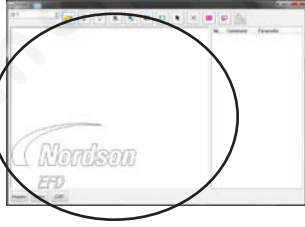
Follow this procedure to import a DXF file, select the desired elements of the imported DXF file, and to generate the commands that will create the selected pattern.

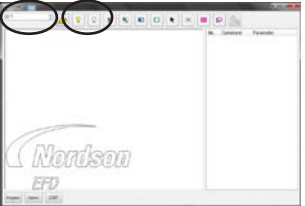

PREREQUISITES

- ❑ The system is properly installed and set up. Refer to “Installation” on page 16 and “Setup” on page 34.
- ❑ Remote Command is disabled. Refer to “Setting Up the System for Remote Operation” on page 115.
- ❑ The Teach Pendant cable is connected to the robot.
- ❑ The system is in the Teach Mode. Refer to “How to Switch from Run Mode to Teach Mode” on page 46.
- ❑ The tip height is calibrated. If the tip was changed, perform a Needle Adjust (systems without a tip aligner) or Auto Needle Adjust (systems with a tip aligner). Refer to “Calibrating the Tip Height” on page 72.
- ❑ The DXF file you want to import is available on the PC.
- ❑ If the imported DXF file has the length units set as inches, the INCH -> MM checkbox on the DXF Option screen is checked. Refer to “Modifying the DXF Import Options” on page 125.
- ❑ The actual workpiece is properly positioned on the fixture plate.

#	Click	Step	Reference Image
1		<ul style="list-style-type: none"> • Click DXF. <p>The DXF screen appears.</p>	
2		<ul style="list-style-type: none"> • Click OPEN A FILE and then double-click on the DXF file you want to import. <p>The file appears in the DXF screen drawing window.</p>	
3	 or 	<ul style="list-style-type: none"> • Hide or show drawing layers as needed: <ul style="list-style-type: none"> - To select individual layers to hide or show, use the drop-down menu at the top left of the screen. - To hide all or show all layers, click HIDE ALL LAYERS or SHOW ALL LAYERS. 	
4	 or 	<ul style="list-style-type: none"> • Select the points and / or lines onto which you want to dispense material. <p>Selected points and / or lines turn blue. For this example, the letters EFD are selected.</p> <p>NOTE: Refer to “1. DXF Screen Editing Icons” on page 123 for an explanation of all the selection icons.</p>	

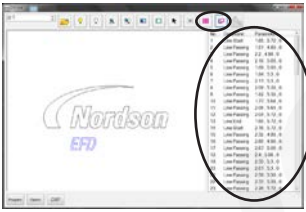
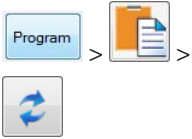
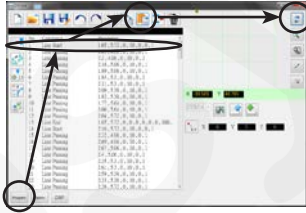

Continued on next page

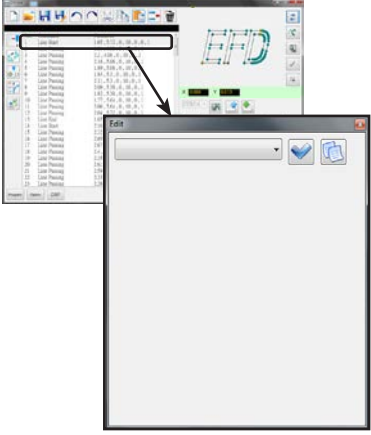
Importing a DXF File (continued)

#	Click	Step	Reference Image
5		<ul style="list-style-type: none"> Click POINT DISPENSE (for dispense dots) or LINE DISPENSE (for lines, arcs, and circles). <p>NOTE: For this example, click LINE DISPENSE because the selection (EFD) is composed of lines.</p> <p>The system generates the program commands that will create the selected pattern.</p>	
6		<ul style="list-style-type: none"> Click the PROGRAM tab, select an empty Address line, then click PASTE and then REFRESH. <p>The commands appear in the Program screen command window and the imported lines appear in the grid window.</p>	
		<p>NOTES:</p> <ul style="list-style-type: none"> - The dispense pattern may appear very small in the grid window. - If the dispense pattern is off the grid window, modify the OFFSET X, Y values in the DXF screen Option window. Refer to "Modifying the DXF Import Options" on page 125. - If the imported DXF file has the length units set as inches, click the INCH -> MM checkbox in the DXF screen Option window and then re-import the file. Refer to "Modifying the DXF Import Options" on page 125 for more information. 	
7		<ul style="list-style-type: none"> In the grid window, left-click and hold to pan the view and use the center scroll wheel to zoom in and out until the selected pattern is easily viewed. Double-click on a command to make changes to the dispense program as needed. After making any change, click REFRESH to update the view in the grid window to show the changes. <p>The next step is to match the program commands to the actual workpiece.</p>	



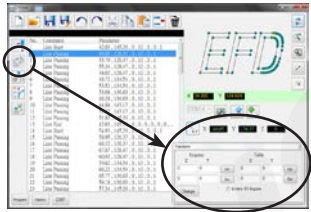

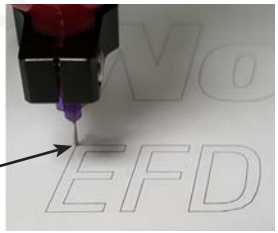
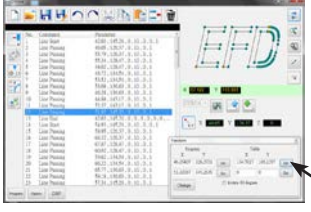

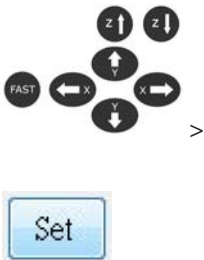

Continued on next page

Importing a DXF File (continued)

#	Click	Step	Reference Image
8		<ul style="list-style-type: none"> Click TRANSFORM. <p>The Transform window appears.</p>	
9		<ul style="list-style-type: none"> Perform screen clicks exactly as shown below to set the PROGRAM points. <p>NOTE: As an example for these steps, the top left and bottom right points of the letter “E” are used.</p>	
10		<ul style="list-style-type: none"> Use the Teach Pendant to jog the tip to the top point on the actual workpiece and then click the top SET button under TABLE. 	 

Continued on next page

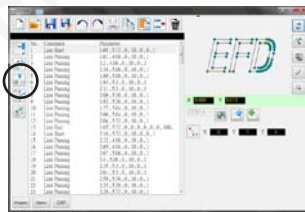
Importing a DXF File (continued)

#	Click	Step	Reference Image
11		<ul style="list-style-type: none"> Use the Teach Pendant to jog the tip to the top point on the actual workpiece and then click the bottom SET button under TABLE. 	 
12		<ul style="list-style-type: none"> Click CHANGE. <p>The system updates all XY locations in the program so they align with same XY locations on the actual workpiece.</p>	
13		<ul style="list-style-type: none"> Select all the commands in the Option screen command window and then click CHANGE Z VALUE to change the Z height to match the actual tip-to-workpiece distance. <p>NOTE: To determine the tip-to-workpiece distance, jog the tip over the workpiece to the desired height and then click Location</p>  <p>Use the displayed Z value as a reference.</p>	
14		<ul style="list-style-type: none"> Click UPLOAD to send the dispense commands to the robot. <p>A progress bar displays the upload status.</p> <p>When the upload is complete, the program is available on the Teach Pendant for further editing.</p>	

Appendix D, Height Sensor Setup and Use

The optional height sensor can detect any variation from the original Z-height program values from workpiece to workpiece. If the Z height changes, the system detects the new Z-height value and adjusts the program accordingly.

```
[Height Sensor]
01 Setup
02 Sensor Position
03 Initial Height Detect
04 Offset Program
```

Menu Item	Description										
01 Setup	Used to enter the following height sensor setup parameters.										
	<table border="1"> <thead> <tr> <th>Parameter</th> <th>Description</th> </tr> </thead> <tbody> <tr> <td>Sensor Input</td> <td>Assigned input port number that the sensor wire is connected to. Default: 0 Range of values: 1-8</td> </tr> <tr> <td>Probe Output</td> <td>Assigned output port number that the probe wire is connected to. Default: 0 Range of values: 1-8</td> </tr> <tr> <td>Detect Speed</td> <td>How fast the Z axis lowers towards the workpiece after the height sensor probe extends. Default: 5 (mm/s) Range of values: 1-20 (mm/s)</td> </tr> <tr> <td>Travel Limit</td> <td>The range within which the Z axis moves to detect the Z-height value. Default: 10 (mm) Range of values: 1-100 (mm)</td> </tr> </tbody> </table>	Parameter	Description	Sensor Input	Assigned input port number that the sensor wire is connected to. Default: 0 Range of values: 1-8	Probe Output	Assigned output port number that the probe wire is connected to. Default: 0 Range of values: 1-8	Detect Speed	How fast the Z axis lowers towards the workpiece after the height sensor probe extends. Default: 5 (mm/s) Range of values: 1-20 (mm/s)	Travel Limit	The range within which the Z axis moves to detect the Z-height value. Default: 10 (mm) Range of values: 1-100 (mm)
	Parameter	Description									
	Sensor Input	Assigned input port number that the sensor wire is connected to. Default: 0 Range of values: 1-8									
	Probe Output	Assigned output port number that the probe wire is connected to. Default: 0 Range of values: 1-8									
Detect Speed	How fast the Z axis lowers towards the workpiece after the height sensor probe extends. Default: 5 (mm/s) Range of values: 1-20 (mm/s)										
Travel Limit	The range within which the Z axis moves to detect the Z-height value. Default: 10 (mm) Range of values: 1-100 (mm)										
02 Sensor Position	Used to view or edit the XYZ location of the height sensor.										
03 Initial Height Detect	Used to view or add a Z-height reference value that the system uses when checking the Z height at a specified location on a workpiece.										
04 Offset Program	Used to update all the Z-height values in an existing program.										

Appendix D, Height Sensor Setup and Use (continued)

To Set Up the Height Sensor

PREREQUISITES

- ❑ The height sensor is installed and the cable is connected to the I/O port. Refer to the instructions provided with the height sensor.
- ❑ The system is properly set up. Refer to “Setup” on page 34.
- ❑ A test workpiece is positioned on the fixture plate or work surface.

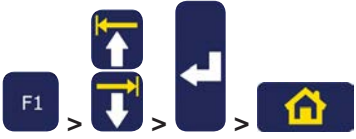
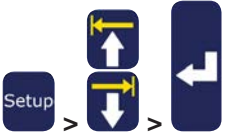
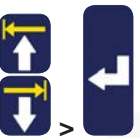
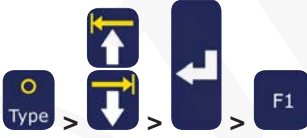
#	Key Press	Step	Teach Pendant Display
1		<ul style="list-style-type: none"> • Press F1. • MOVE UP / DOWN to TEACH/RUN. • Press ENTER. • Press HOME. If prompted, enter a password. <p>The system opens the last program number that was modified prior to shutdown.</p>	<div style="border: 1px solid black; padding: 5px;"> <pre>[PROGRAM MENU] 1/1 01*Teach/Run 02 Program List 03 Reset Counter 04 Program Offset 05 Needle Adjust 06 Auto Needle Adjust</pre> </div>
2		<ul style="list-style-type: none"> • Press SETUP. • MOVE UP / DOWN to HEIGHT SENSOR. • Press ENTER. 	<div style="border: 1px solid black; padding: 5px;"> <pre>[SETUP] 3/3 15 Measurement Unit 16 Password Setup 17 Remote Command 18*Height Sensor 19 Language 20 System Information</pre> </div>
3		<ul style="list-style-type: none"> • MOVE UP / DOWN to SETUP. • Press ENTER. 	<div style="border: 1px solid black; padding: 5px;"> <pre>[Height Sensor] 01*Setup 02 Sensor Position 03 Initial Height Detect 04 Offset Program</pre> </div>
4		<ul style="list-style-type: none"> • Use the MOVE UP / DOWN keys and the ENTER key to enter the following starting values: <ul style="list-style-type: none"> - Sensor Input: As connected on your system - Probe Output: As connected on your system - Detect Speed: 5 - Travel Limit: 20 • Press F1. 	<div style="border: 1px solid black; padding: 5px;"> <pre>Height Sensor Setup ----- Sensor Input 8 Probe Output 8 Detect Speed 5 mm/s Travel Limit 20 mm [F1] OK</pre> </div>

Continued on next page

Appendix D, Height Sensor Setup and Use (continued)



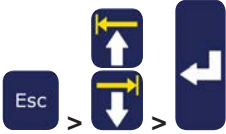
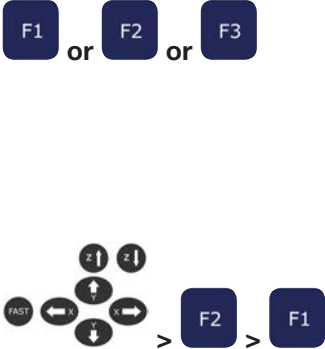
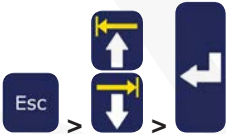

To Set Up the Height Sensor (continued)

#	Key Press	Step	Teach Pendant Display
5		<ul style="list-style-type: none"> Press ESC to return to the Height Sensor menu. MOVE UP / DOWN to SENSOR POSITION. Press ENTER. 	<pre>[Height Sensor] 01 Setup 02*Sensor Position 03 Initial Height Detect 04 Offset Program</pre>
6		<ul style="list-style-type: none"> On the Sensor Position menu, select one of the following: <ul style="list-style-type: none"> Press F1 to accept the current Height Sensor probe XYZ location. Press F2 to move the Height Sensor probe to the programmed XYZ location. Press F3 and then use the jog keys to move the probe to the desired XYZ location. Press F2 to lower or raise the probe as needed. (When the tip is raised, the Sensor status is 0; when the tip is down, the Sensor status is 1.) Press F1 to save the location. <p>NOTE: The tip should be positioned over a suitable location on the workpiece (an area that is open and will be safe for the tip to touch) to test the height sensor.</p>	<pre>Sensor Position ----- X: 000.00 mm Y: 000.00 mm Z: 000.00 mm [F1] OK [F2] Move [F3] Jog</pre> <pre>Sensor Position ----- Jog sensor to position Sensor status x ----- [F1] OK [F2] Probe</pre>
7		<ul style="list-style-type: none"> Press ESC to return to the Height Sensor menu. MOVE UP / DOWN to INITIAL HEIGHT DETECT. Press ENTER. 	<pre>[Height Sensor] 01 Setup 02 Sensor Position 03*Initial Height Detect 04 Offset Program</pre>

Continued on next page

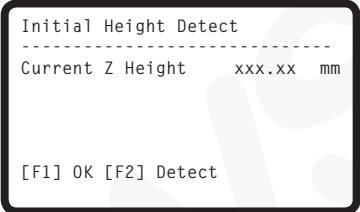
Appendix D, Height Sensor Setup and Use (continued)

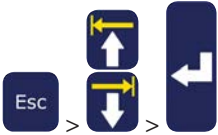
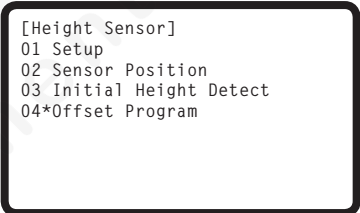
To Set Up the Height Sensor (continued)

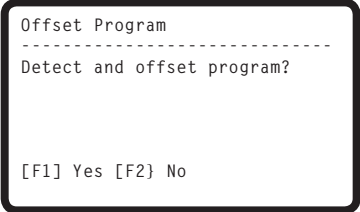
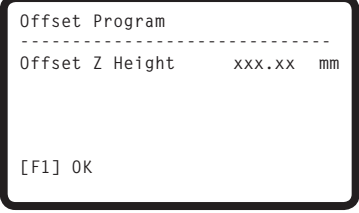
#	Key Press	Step	Teach Pendant Display
8		<p>The screen shows the current Z height of the workpiece. Do one of the following:</p> <ul style="list-style-type: none"> Press F1 to accept the current Z-height value. Press F2 to detect the Z-height value, then press F1 to accept the value. <p>The system is now ready for height sensor detection. Do one of the following:</p> <ul style="list-style-type: none"> Continue to the next step to update the Z-height values in the currently open program. Continue to the next procedure in this section to use this feature in a program. 	 
9		<ul style="list-style-type: none"> (Optional) Press ESC to return to the Height Sensor menu. MOVE UP / DOWN to OFFSET PROGRAM. Press ENTER. 	
10		<ul style="list-style-type: none"> Press F1 to check the Z height of the current XYZ location. <p>The system checks the current Z height by lowering and raising the probe. If the detected Z-height value is different from the Z-height value in the program, the system prompts for confirmation to update the Z-height values.</p> <ul style="list-style-type: none"> Press F1 to accept the offset value. The system automatically updates all the Z-height values in the program. 	 

Appendix D, Height Sensor Setup and Use (continued)

To Use the Height Sensor Capability

PREREQUISITES

- ❑ The system is properly set up. Refer to “Setup” on page 34.
- ❑ The height sensor is installed, enabled, and set up. Refer to “Appendix D, Height Sensor Setup and Use” on page 130.
- ❑ The program you want to edit using the height sensor capability is open.

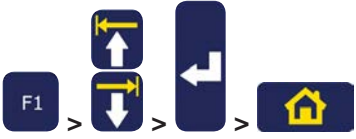
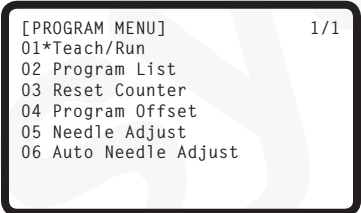
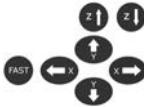
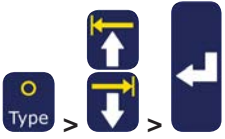
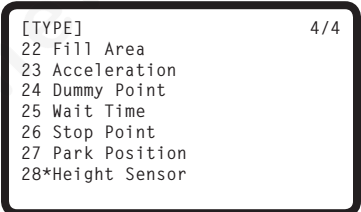
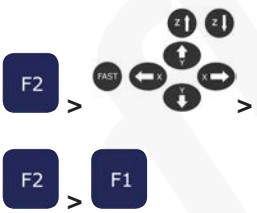
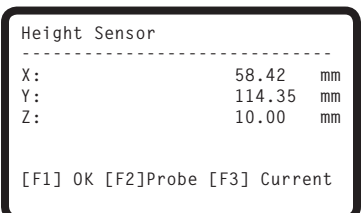
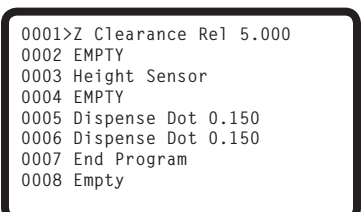
#	Key Press	Step	Teach Pendant Display
1		<ul style="list-style-type: none"> • Press F1. • MOVE UP / DOWN to TEACH/RUN. • Press ENTER. • Press HOME. If prompted, enter a password. <p>The system opens the last program number that was modified prior to shutdown.</p>	
2		<ul style="list-style-type: none"> • Jog to the location where the system should check the height for each workpiece. 	
3		<ul style="list-style-type: none"> • Press TYPE. • MOVE UP / DOWN to HEIGHT SENSOR. • Press ENTER. 	
4		<ul style="list-style-type: none"> • Press F2 to lower the probe. • Use the Z jog keys to move the probe to the desired XYZ location and then lower the probe to approximately 10 mm (0.4”) above the location • Press F2 to raise the probe. • Press F1 to accept the value. <p>The system will now check the workpiece height each time the programs runs.</p> <p>An example program is shown at right.</p>	
			

NORDSON EFD ONE YEAR LIMITED WARRANTY

This Nordson EFD product is warranted for one year from the date of purchase to be free from defects in material and workmanship (but not against damage caused by misuse, abrasion, corrosion, negligence, accident, faulty installation, or by dispensing material incompatible with equipment) when the equipment is installed and operated in accordance with factory recommendations and instructions.

Nordson EFD will repair or replace free of charge any defective part upon authorized return of the part prepaid to our factory during the warranty period. The only exceptions are those parts which normally wear and must be replaced routinely, such as, but not limited to, valve diaphragms, seals, valve heads, needles, and nozzles.

In no event shall any liability or obligation of Nordson EFD arising from this warranty exceed the purchase price of the equipment.

Before operation, the user shall determine the suitability of this product for its intended use, and the user assumes all risk and liability whatsoever in connection therewith. Nordson EFD makes no warranty of merchantability or fitness for a particular purpose. In no event shall Nordson EFD be liable for incidental or consequential damages.

This warranty is valid only when oil-free, clean, dry, filtered air is used, where applicable.

To register your equipment, please go to www.nordsonefd.com/warranty/robots/one

