

# PICO *Pulse* Series Valves

## Operating Manual

### Models Included:

- PICO *Pulse*
- PICO *Pulse* XP
- PICO *Pulse* Contact



Electronic pdf files of Nordson EFD manuals are also available at [www.nordsonefd.com](http://www.nordsonefd.com)



You have selected a reliable, high-quality dispensing system from Nordson EFD, the world leader in fluid dispensing. Nordson EFD dispensing systems are designed specifically for industrial dispensing and will provide you with years of trouble-free, productive service.

This manual will help you maximize the usefulness of your dispensing system.

Please spend a few minutes to become familiar with the controls and features. Follow our recommended testing procedures. Review the helpful information we have included, which is based on more than 50 years of industrial dispensing experience.

Most questions you will have are answered in this manual. However, if you need assistance, please do not hesitate to contact EFD or your authorized EFD distributor. Detailed contact information is provided on the last page of this document.

## The Nordson EFD Pledge

Thank You!

You have just purchased the world's finest precision dispensing equipment.

I want you to know that all of us at Nordson EFD value your business and will do everything in our power to make you a satisfied customer.

If at any time you are not fully satisfied with our equipment or the support provided by your Nordson EFD Product Application Specialist, please contact me personally at 800.556.3484 (US), 401.431.7000 (outside US), or [Jamie.Clark@nordsonefd.com](mailto:Jamie.Clark@nordsonefd.com).

I guarantee that we will resolve any problems to your satisfaction.

Thanks again for choosing Nordson EFD.

*Jamie*  
Jamie Clark, Vice President

# Contents

Contents .....	3
Introduction .....	4
Valve Configuration Options .....	5
Piezo Actuator .....	5
Fluid Body Assembly .....	5
Fluid Inlet Fitting .....	5
PEEK Wetted Parts .....	5
HD Piezo Actuator for Contact Dispensing .....	6
How the Valve Operates .....	6
How the Valve is Controlled .....	6
Nordson EFD Product Safety Statement .....	7
Specifications .....	8
Operating Features .....	9
Installation .....	10
Install the Ancillary System Components .....	10
Install the Fluid Body Assembly .....	10
Install the Valve .....	11
Install the Tip Adapter (Option) .....	12
Make the System Connections .....	13
Fluid Body Assembly Removal and Installation .....	14
Service .....	16
Recommended Maintenance Schedule .....	16
Cleaning the Exterior of the Valve .....	16
Cleaning the Interior of the Valve .....	17
Clean by Purging with the Dispensing Fluid .....	17
Clean by Purging with a Cleaning Fluid .....	18
Clean by Rebuilding the Fluid Body Assembly .....	20
Accessories .....	32
Tip Adapter Kits .....	32
Valve Extension Cables for the Standard <i>Touch</i> Controller .....	33
Valve Extension Cables for the <i>Touch</i> XP Controller .....	33
Regulators, Brackets, and High Pressure Adapter Kits .....	34
Fluid Inlet Fittings .....	35
Replacement Parts .....	36
Piezo Actuator .....	36
Fluid Body Assemblies .....	37
Flat Nozzle Fluid Body Assemblies .....	38
PEEK Fluid Body Assemblies (Flat Nozzle Only) .....	39
Flat Nozzle Coated / Conditioned Fluid Body Assemblies .....	40
P7 Extended Nozzle Coated / Conditioned Fluid Body Assemblies .....	40
P7 Extended Nozzle Fluid Body Assemblies .....	41
P30 Extended Nozzle Fluid Body Assemblies .....	41
Fluid Body Assembly Components .....	42
Rebuild Kit, Cleaning Kit, and Special Tools .....	43
Troubleshooting .....	44

## Introduction

The PICO *Pulse*® modular valve is an electrically operated, modular, piezo-actuated dispensing valve designed for high-speed, accurate dispensing. The *Pulse* valve can apply precise microdeposits (as low as fractions of a microliter) of fluids onto a substrate, making it ideal for dispensing onto hard-to-access areas or uneven or delicate substrates. The fluid to be dispensed is pneumatically supplied to the valve through a reservoir, such as a pressure tank or pump.

### Valve Speed and Deposit Size

Due to the extremely fast piezo actuator, fluid dispensing frequencies of up to 1500Hz\* are possible. Precision engineered *Pulse* valves can dispense dots as small as 0.5 nL (depending on the fluid nozzle plate orifice). Because pulse times can be adjusted in increments as small as 0.01 ms, it is possible to set a very exact dispensing quantity.

\*With approved conditional settings

### Modular, Exchangeable Components

Because the valve's components are modular and exchangeable, the time required to service the valve can be as little as the few seconds required to change out the fluid body assembly. The modular design also facilitates valve service because the entire fluid body assembly can be removed and disassembled for cleaning purposes.

### Diverse Fluid Dispensing

The *Pulse* valve is suitable for the precise dispensing of a variety of chemically diverse fluids. These fluids may have various viscosities and may also contain fillers. To meet the dispensing requirements for a broad range of fluids, a range of dispensing accessories are available to allow:

- Non-contact dispensing of individual free-flying droplets onto surfaces/parts
- Non-contact dispensing of a fluid stream
- Tip dispensing for contact applications

### Easy Integration into Systems

Integration into automation systems is easily accomplished because of the *Pulse* valve's compact size and the number of fixturing / mounting holes available on the valve body. The installation position (vertical, horizontal, angled, pointing upward, etc.) does not impact valve performance.

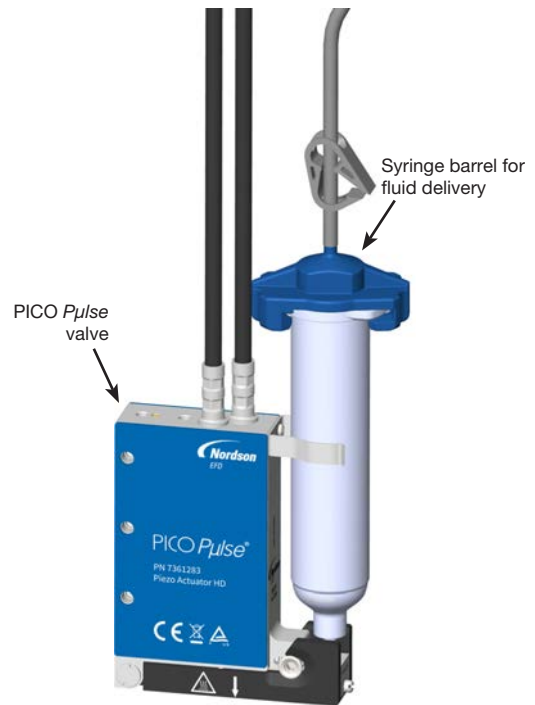

## Introduction (continued)

### Valve Configuration Options

The *Pulse* valve has several configuration options for maximum fluid and application compatibility.

#### Piezo Actuator

Three types of piezo actuator are available: Standard Duty (SD), Heavy Duty (HD), and Extreme Precision (XP). HD piezo actuators are designed for high-duty cycle applications and also for contact dispensing applications. XP piezo actuators are designed for applications that require extremely precise, repeatable micro-deposits where strict tolerances or deposit definition must be met.



#### Fluid Body Assembly

Fluid body assemblies are available with flat or extended nozzles in seat sizes ranging from 50–600 microns with a choice of Type D and Type E geometries.

Specially coated / conditioned fluid body assemblies are available for applications that require tighter tolerances and improved jetting quality. Refer to “Fluid Body Assemblies” on page 37 for details.

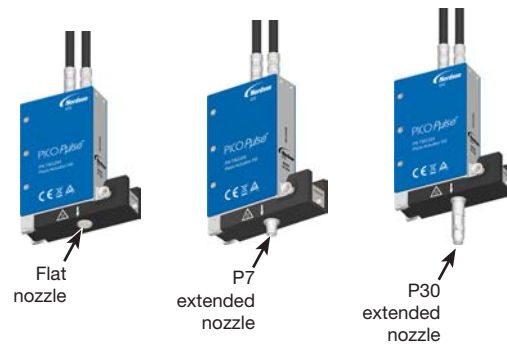

#### Fluid Inlet Fitting

Many sizes and types of fluid inlet fittings are available, including barb, compression, and luer lock fitting types.



#### PEEK Wetted Parts

Flat-nozzle fluid body assemblies made with PEEK\* wetted parts are available. PEEK fluid body assemblies prevent curing and clogging when dispensing anaerobic and UV-cure anaerobic adhesives. This results in less frequent cleaning, maintenance, and downtime, thus leading to higher assembly line throughput and productivity. Also, better “dampening” between the heater block and PEEK fluid body assemblies reduces vibration and cycling harmonics to improve deposit consistency.

\*Polyetheretherketone



PEEK components available for a fluid body assembly

## Valve Configuration Options (continued)

### HD Piezo Actuator for Contact Dispensing

An HD *Pulse* contact dispense valve developed specifically for contact dispensing applications is available. When combined with one of three available tip adapter kits, this valve can be used for many high-speed contact dispensing applications. The valve features three holes in the heater block for attaching the required tip adapter assembly.

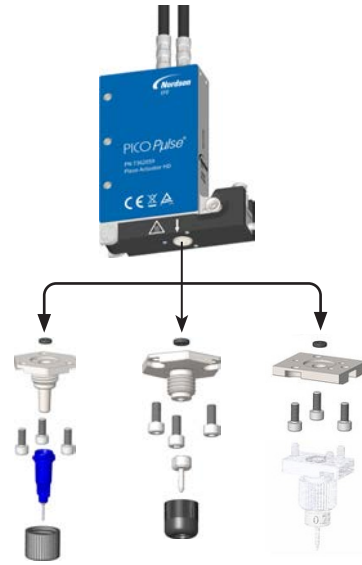

### How the Valve Operates

The *Pulse* valve is driven by piezo actuators. Piezo movement is imparted to a rod via a lever located in the piezo actuator. The movement of this rod is imparted to a shutoff ball stem in the valve seat. The sealing ball is made of wear-resistant ceramic, which is attached at the lower end.

In the closed position, the ceramic ball seats into a ceramic nozzle seat, preventing any fluid flow.

When the ceramic ball is lifted, fluid flows through the nozzle and is dispensed.

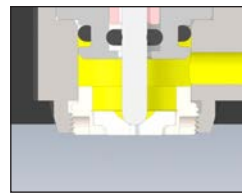

Valve closed

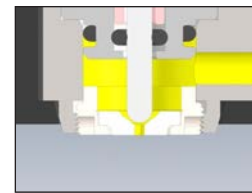

Valve opened

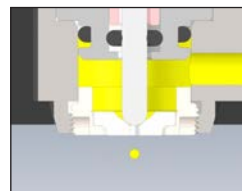

Valve closed, with resulting deposit shown

### How the Valve is Controlled

The PICO *Touch*™ valve controller provides an easy-to-use and intuitive touchscreen interface for setup and control of the *Pulse* valve. Refer to the PICO *Touch* controller manual for complete installation, setup, and operation information.

**NOTE:** A *Pulse* XP valve must be controlled by a *Touch* XP controller.



PICO *Touch* controller for PICO *Pulse* SD and HD valves



PICO *Touch* XP controller for PICO *Pulse* XP valves only

# Nordson EFD Product Safety Statement

**NOTE:** The following safety information is specific to the PICO *Pulse* valve. For a complete Nordson EFD product safety statement, refer to the PICO *Touch* controller manual.

## WARNING

The safety message that follows has a WARNING level hazard.  
Failure to comply could result in death or serious injury.

## CAUTION

The safety message that follows has a CAUTION level hazard.  
Failure to comply may result in minor or moderate injury.

## CAUTION

**Do not dry cycle the PICO *Pulse* valve!** The ceramic nozzle seat and ball can be damaged if the *Pulse* valve is operated without fluid, causing leakage and a poor seal. Precise dispensing can no longer be guaranteed if this occurs.

### Intended Use

Use the *Pulse* valve only in conjunction with the *Touch* controller, its associated power cable and, if needed, its associated extension cable.

Nordson EFD recommends avoiding the use of dispensing fluids that could damage or are not compatible with the following wetted materials present inside the *Pulse* valve:

- Stainless steel grade 1.4305 (AISI grade 303)
- Ceramic
- Viton® (exterior O-ring option)
- Perfluoroelastomer

Anaerobic methacrylates and pre-mixed two-part adhesives with a short pot life are not recommended because they can cure or harden in the valve, causing failure.

Dispensing of cyanoacrylates is possible under certain conditions. Contact your Nordson EFD representative for recommendations and technical support.

### Unintended Fluid Release

- Prior to initial operation, check to see if fluid flows out of a valve that is turned off even when no fluid pressure is being applied. If this occurs, it may be because the fluid reservoir is positioned higher than the valve, in which case hydrostatic pressure causes the fluid to flow out of a valve that is not closed. Position the fluid reservoir low enough such that no fluid leaks from the valve when the valve is shut off.
- In the case of damage to the piezo actuator or the *Touch* controller, the valve may transition from a CLOSED to OPEN condition, which can cause fluid release. Nordson EFD recommends continually monitoring the status signal of the *Touch* controller and immediately and automatically bleeding the fluid reservoir if these signals indicate an error.
- Before connecting or disconnecting a valve cable, release fluid pressure and disconnect and lock out power to the *Touch* controller.

### Personal Safety

- Provide operators with appropriate identification and protection against contact in case the valve temperature exceeds +45° C (113° F).
- To divert static charges from the *Pulse* valve, connect it to the machine system ground. Vacant fastening threads may be used for this.

# Specifications

**NOTE:** Specifications and technical details are subject to change without prior notification.

Item	Specification										
Size	22.0W x 120.0H x 75.0L mm (0.87W x 4.72H x 2.92L")										
Weight	<table border="0"> <tr> <td><b><i>Pulse non-contact jet valve</i></b></td> <td><b><i>Pulse contact dispense valve</i></b></td> </tr> <tr> <td>With cable: 524.0 g (18.5 oz)</td> <td>With tip adapter / with cable: 538.0 g (19.0 oz)</td> </tr> <tr> <td>Without cable: 362.0 g (12.8 oz)</td> <td>With tip adapter / without cable: 376.0 g (13.3 oz)</td> </tr> <tr> <td></td> <td>Without tip adapter / with cable: 524.0 g (18.5 oz)</td> </tr> <tr> <td></td> <td>Without tip adapter / without cable: 362.0 g (12.8 oz)</td> </tr> </table>	<b><i>Pulse non-contact jet valve</i></b>	<b><i>Pulse contact dispense valve</i></b>	With cable: 524.0 g (18.5 oz)	With tip adapter / with cable: 538.0 g (19.0 oz)	Without cable: 362.0 g (12.8 oz)	With tip adapter / without cable: 376.0 g (13.3 oz)		Without tip adapter / with cable: 524.0 g (18.5 oz)		Without tip adapter / without cable: 362.0 g (12.8 oz)
<b><i>Pulse non-contact jet valve</i></b>	<b><i>Pulse contact dispense valve</i></b>										
With cable: 524.0 g (18.5 oz)	With tip adapter / with cable: 538.0 g (19.0 oz)										
Without cable: 362.0 g (12.8 oz)	With tip adapter / without cable: 376.0 g (13.3 oz)										
	Without tip adapter / with cable: 524.0 g (18.5 oz)										
	Without tip adapter / without cable: 362.0 g (12.8 oz)										
Maximum fluid pressure	35.0 bar (500 psi)										
Fluid inlet	M5										
Mounting	M4 x 0.7 Tip adapter kits for HD contact valves: M2.5 X 0.45										
Continuous running condition maximums and minimums (see NOTES below)	Maximum stack temperature: 85° C (185° F) Maximum continuous operating frequency: 1000Hz or 1 ms Maximum burst frequency: up to 1500Hz* Minimum opening time: 0.25 ms Maximum opening time: 0.50 ms Minimum closing time: 0.20 ms Maximum closing time: 2.00 ms Maximum stroke, standard valve: 90% Maximum stroke, XP: 165 µm Maximum close voltage: 120V (when a Delta of 90V is applied for voltages above 100V)										
Fluid body	303 stainless steel or PEEK										
Ball and seat	Ceramic										
Heater body	Aluminum										
Tip adapter kits for HD contact valves	303 stainless steel										
Maximum fluid body temperature (see NOTES below)	100° C (212° F) (except PEEK) PEEK: 45° C (113° F)										
Product classification	Installation Category 2 Pollution Degree 2										
Approvals	CE, UKCA, WEEE, TUV										
*With approved conditional settings											

## NOTES:

- Continuous running condition maximums apply when the stack temperature does not exceed 55° C (131° F) for an SD valve or 85° C (185° F) for an HD valve. The valves can be subject to other operating conditions as long as the stack temperature does not exceed these temperature maximums.
- Tip adapter kits are for use with HD contact valves only.
- The maximum fluid body temperature for valves with a PEEK fluid body assembly is 45° C (113° F).

## WEEE Directive



This equipment is regulated by the European Union under WEEE Directive (2012/19/EU). Refer to [www.nordsonefd.com/WEEE](http://www.nordsonefd.com/WEEE) for information about how to properly dispose of this equipment.



# Operating Features

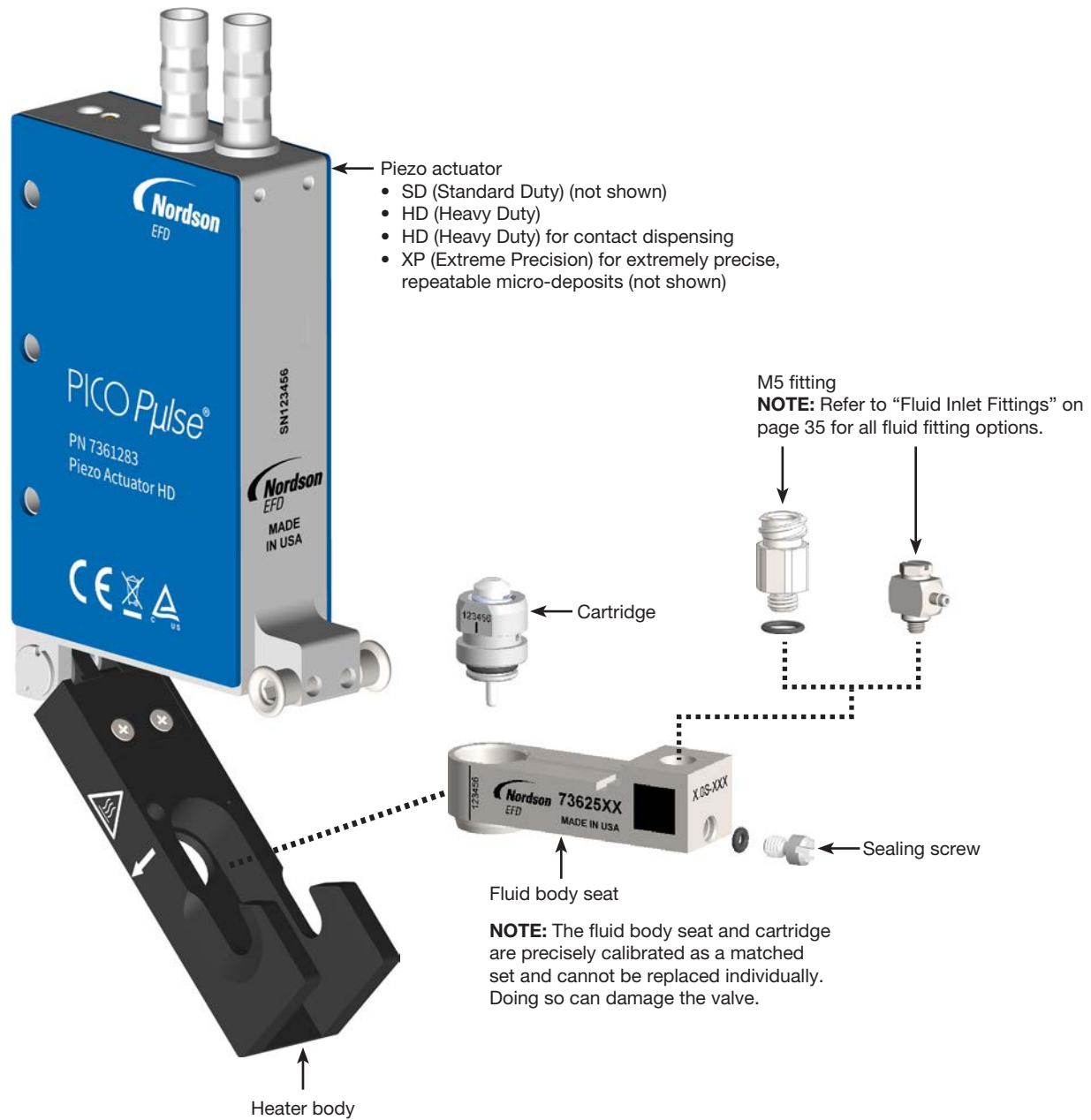

## Installation

Prior to installing the valve, read the associated reservoir and valve controller operating manuals to become familiar with the operation of all components of the dispensing system.

### Install the Ancillary System Components

Install any components other than the *Pulse* valve and controller that will comprise the complete dispensing system. For example, if you are using a fluid reservoir, position and install all the fluid reservoir components. For all ancillary components, refer to the quick start guide and / or operating manual provided with those components for installation, setup, and operating instructions.

### Install the Fluid Body Assembly

1. Open the heater body of the piezo actuator by pushing the latch pin back towards the valve.

**NOTE:** For installations with limited side access, an optional latch release tool is available. Refer to “Rebuild Kit, Cleaning Kit, and Special Tools” on page 43 for the part number.

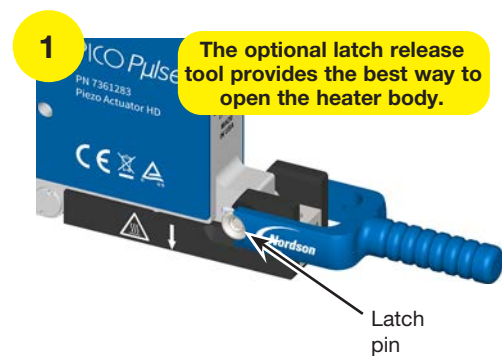

2. Insert the fluid body assembly and close the heater body, ensuring it is fully engaged.

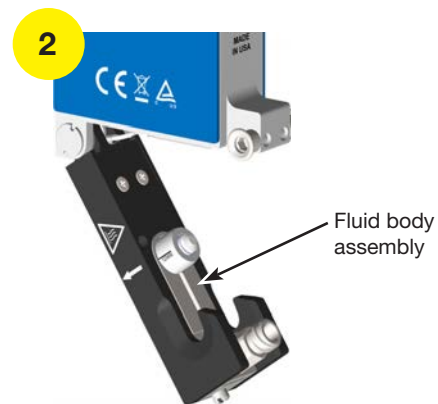

# Installation (continued)

## Install the Valve

Referring to the guidelines below, install the *Pulse* valve on the dispensing equipment:

- Nordson EFD strongly recommends using a valve mounting bracket. There are multiple mounting holes to allow for adjustment. Some valve mounting examples are shown below.
- For repeatable mounting-location precision, use alignment dowels to mount the valve on the frame side.
- When mounting the valve, do not install bracketing that could apply pressure to either side panel. Doing so can damage the piezoactuator, compromising valve performance.

### About Installing *Pulse* XP Valves

For *Pulse* XP valves, proper mounting is critical to ensure correct operation. Forces applied to the valve where the fluid supply attaches can cause strain movements of the fluid body assembly, which can result in calibration errors if the strain movements are too large (alarm code b17 020 on the *TouCh* controller).

- When mounting a *Pulse* XP valve, ensure that the fluid supply feed loads are properly supported to prevent movement of the fluid body assembly.
- For the best stabilization method, use a mounting bracket (refer to “Regulators, Brackets, and High Pressure Adapter Kits” on page 34 for available brackets).

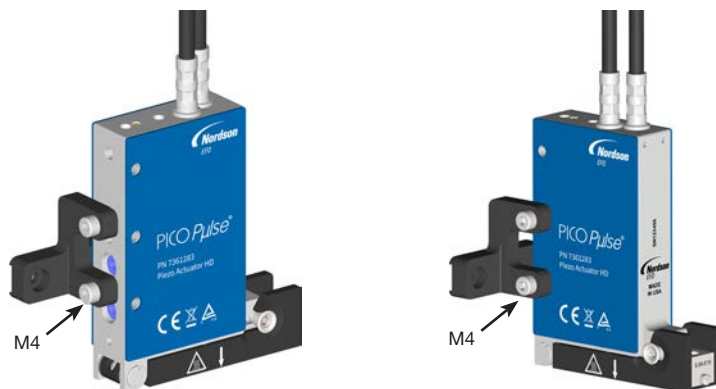

Examples of valve mounting using the optional bracket

Do not install any bracketing past the mounting holes on the valve.



## Install the Tip Adapter (Option)

If installing the piezo actuator for contact dispensing (P/N 7362059), install the applicable tip adapter kit components. Refer to “Rebuild Kit, Cleaning Kit, and Special Tools” on page 43 for adapter kit part numbers.

**NOTE:** Tip adapter retaining nuts should be finger-tightened.

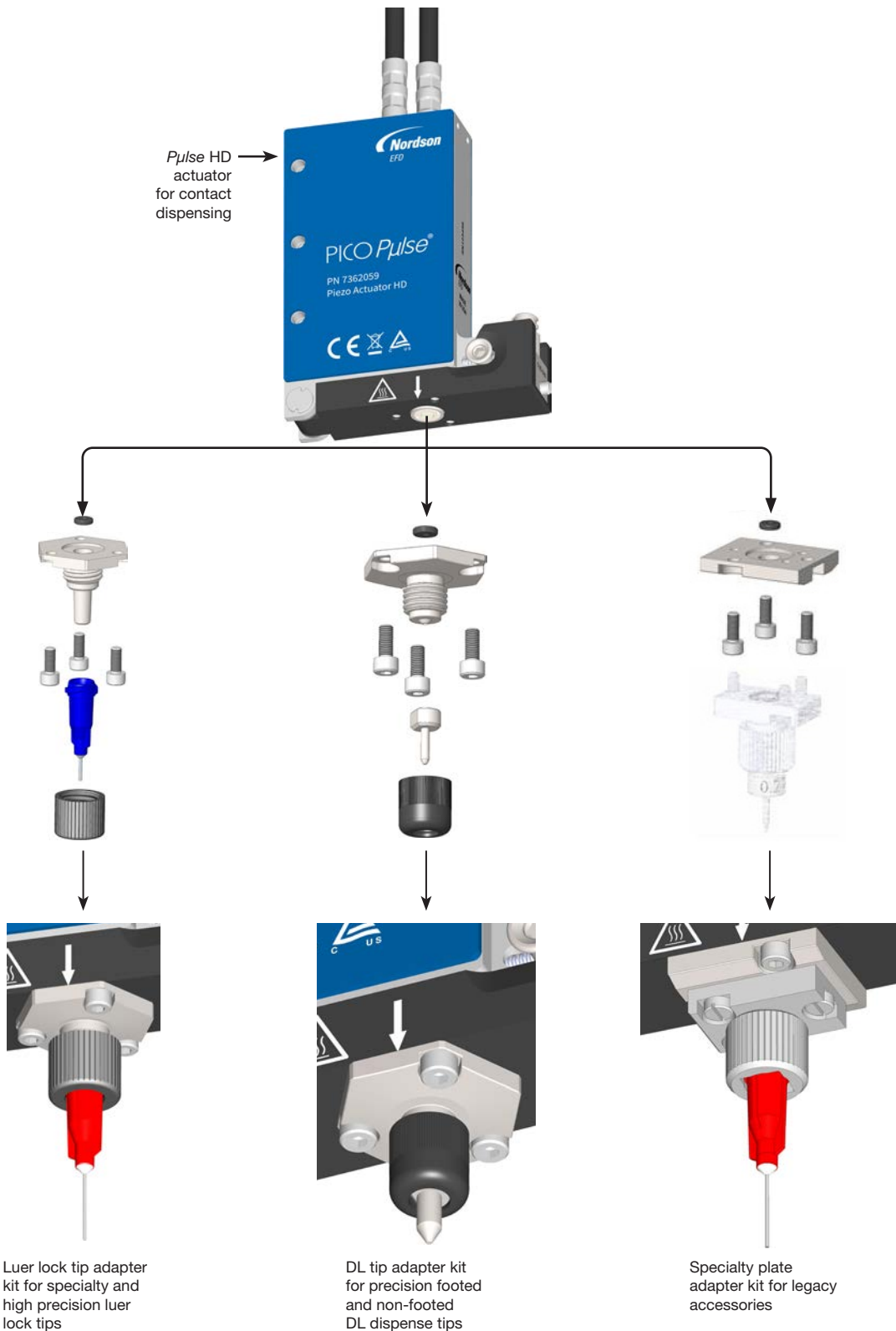

## Make the System Connections

These system installation illustrations provide an overview of a typical installation of a PICO *Pulse* valve and *Touch* controller system. For complete installation, setup, and testing instructions, refer to the *Touch* controller operating manual.

### ⚠ CAUTION

Do not exceed the maximum extension cable length of 9 m (30 ft). Doing so will adversely affect communication between the valve and the controller.

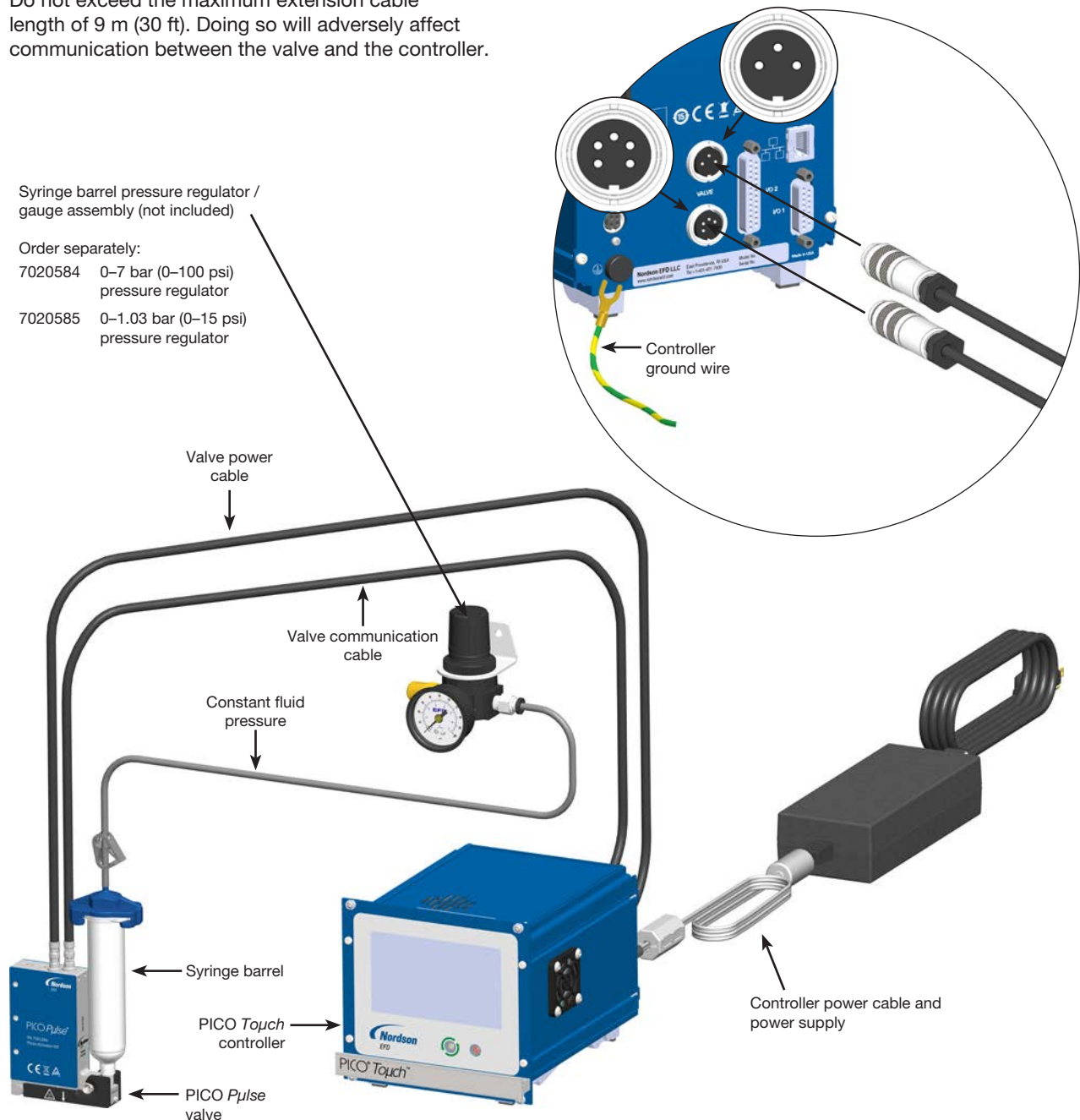

### ⚠ CAUTION



Always depressurize a reservoir before opening it. For tank installations: (1) slide the shutoff valve on the air line away from the reservoir and (2) open the pressure relief valve. Before opening the reservoir, check the pressure gauge to verify that pressure is zero (0). For syringe barrel installations, disconnect the adapter assembly from the reservoir pressure regulator and gauge. On all EFD syringe barrels, the unique threaded design provides fail-safe air pressure release during cap removal.

## Fluid Body Assembly Removal and Installation

You can quickly remove the fluid body assembly of the *Pulse* valve and install a replacement fluid body assembly, thus greatly minimizing down time. The removed fluid body assembly can be serviced and ready for use for the next required fluid body assembly change-out.

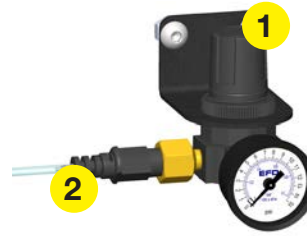

1. Shut off the fluid pressure to the valve.
2. Disconnect the fluid supply from the pressure regulator by disconnecting the quick-connect assembly.



3. At the *Touch* controller, press the VALVE icon (  ) and then press POWER to switch the valve OFF.
4. Press the CHECK (  ) icon to confirm.



Switching valve POWER to OFF (standard *Touch* controller VALVE screen shown)

5. If the valve is heated, press the HEATERS icon (  ) and then press OFF.
6. Press HOME (  ) to return to the HOME screen.



Switching OFF heater control and returning to the HOME screen

## Fluid Body Assembly Removal and Installation (continued)

7. Disconnect the adapter from the syringe barrel.

**NOTE:** For low viscosity fluids, first engage the hose clamp on the syringe adapter assembly to prevent fluid dripping.

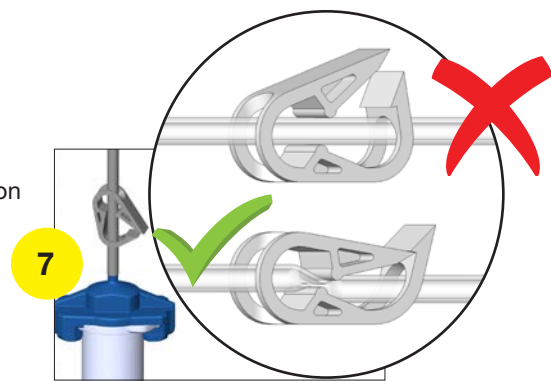

Hose clamp on a syringe barrel adapter assembly

### ⚠ CAUTION

To prevent damage to the tappet, remove the syringe barrel before opening the heater body.

8. **Important:** Remove the syringe barrel from the fluid inlet fitting.



**Important:** To prevent damage to the tappet, remove the syringe barrel **BEFORE** removing the fluid body assembly.

### ⚠ CAUTION

When opening the heater body, be ready to catch the fluid body assembly. Dropping the assembly can damage it.

9. Push both sides of the latch pin towards the piezo actuator to open the heater body. This completely frees the fluid body assembly.

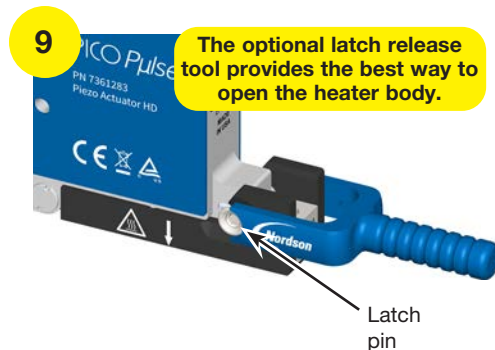

10. Remove the fluid body assembly from the heater body by pulling up on the fluid inlet fitting.
11. Insert the new fluid body assembly and close the heater body, ensuring it is fully engaged.

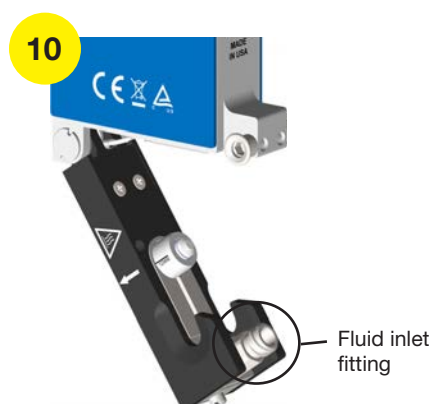

## Service

Maintenance and inspection of wear parts (such as the fluid body assembly) is recommended after 10,000,000 dispensing cycles. This can vary depending on the type of fluid body assembly and fluid dispensed. Contact your Nordson EFD representative for additional information on valve wear and damage.

Valve service refers to a preventive cleaning of the valve's wetted components, particularly in the fluid flow path areas. To service the valve, conduct a visual inspection of all areas of the wetted parts for wear and damage and use the procedures in this section to clean the valve or to replace the fluid body, cartridge, or other individual parts as needed.

### CAUTION

Before any component change or service activity, relieve air pressure from the fluid reservoirs and switch off heater control (if applicable).

## Recommended Maintenance Schedule

Cleaning and maintenance intervals vary based your operating conditions (dispensing frequency, frequency of use, dispensing material, etc.). The following table provides recommendations only.

Component	Recommended Replacement Interval
Tappet sealing O-ring replacement	100 million cycles or as needed depending on the dispensing material.
Cartridge spring, guide, and cartridge body O-ring	250 million cycles or as needed depending on the dispensing material.
Fluid inlet fitting and O-ring	250 million cycles or as needed depending on the dispensing material.

**NOTE:** The sealing effectiveness of O-rings can be compromised if the replacement intervals are too long, causing worn or damaged O-rings. Worn or damaged O-rings can compromise valve operation.

## Cleaning the Exterior of the Valve

### CAUTION

Do not use dripping wet cloths and do not pour solvents, alcohol, water, or other liquids directly onto the piezo actuator. Do not submerge the piezo actuator in the cleaning agent. Doing so can introduce liquid into the electromechanical drive area and destroy it.

To clean the valve exterior, use a soft cotton or cellulose cloth. If the valve is extremely dirty, slightly moisten the cloth with alcohol.



## Service (continued)

### Cleaning the Interior of the Valve

To precisely dispense accurate, small amounts of fluid, the *Pμ*lse valve has an extremely small opening. This opening can become clogged or blocked by very small contaminants, adversely affecting dispensing results.

#### How to Determine if Valve Cleaning is Needed

Valve contamination is manifested by the following symptoms:

- Poor dispensing.
- Residual flow of the fluid after the valve closes, in which drops or a film form on the exterior side of the nozzle plate.
- No fluid flow, caused by clogging of the nozzle plate orifice.



Poor valve operation is not always caused by contamination. Check the following first:

- Is the valve properly connected? Check the cable connections between the dispensing valve, the *Touch* controller, and the PLC or other controllers to ensure that power is supplied. Is the controller display ON?
- Is the valve supplied with fluid? Check the fluid amount. Check the pressure supply.
- Are the setup parameters correct? Check the dispensing parameters, the valve setpoint temperature, and the input and output reservoir pressure.
- Is an alarm code displayed on the controller?
- Does the valve work when dispensing is activated? The mechanical opening and closing is normally audible (depending on the fluid and ambient noise level).

If other potential errors have been ruled out and the problem persists, continue to the following procedures to clean the valve.

### Clean by Purging with the Dispensing Fluid

Before disassembling the valve to clean it, first attempt to remove the contamination by purging the valve.

1. At the *Touch* controller, press the VALVE icon (  ).
2. Press and hold the PURGE icon (  ) until the fluid stream flows clean, then release PURGE.  
**NOTE:** With some fluids, the pressure supply must be increased to improve flow.
3. Test the operation of the valve. If purging does not remove the contamination, continue to the next procedure to rinse the fluid path with a cleaning fluid.



Location of the PURGE button (standard *Touch* controller VALVE screen shown)

## Service (continued)

### Clean by Purging with a Cleaning Fluid

If purging the valve does not resolve clogging or contamination issues, try purging the fluid path with a cleaning fluid.

**NOTE:** Clarify with the fluid manufacturer which cleaning fluid is best suited for cleaning the dispensed fluid.

#### To Connect a Supply of Cleaning Fluid

1. Depressurize the reservoir:
  - a. (Syringe barrel installations) Disconnect the barrel adapter quick-connect from the fluid pressure regulator.

**OR**

  - b. (Tank installations) Turn off the air pressure to the tank and open the pressure relief valve on the tank lid.

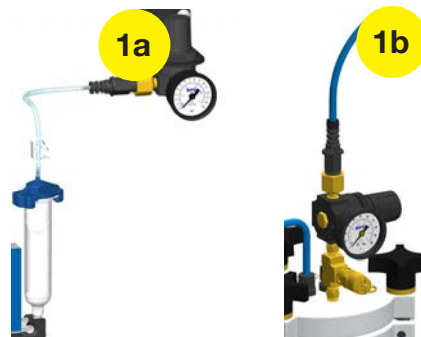

De-pressurize a syringe barrel (1a) or tank (1b) reservoir

2. Stop the fluid supply to the valve:
  - a. (Syringe barrel installations) Disconnect the syringe barrel adapter from the barrel.

**OR**

  - b. (Tank installations) Disconnect the fluid line fitting from the fluid inlet fitting on the valve.

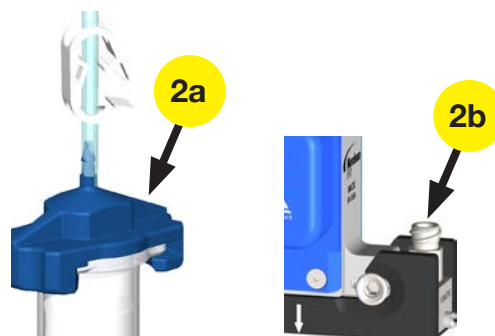

Stop the fluid supply from a syringe barrel (2a) or tank (2b) reservoir

3. Connect a supply cleaning fluid:
  - a. Replace the syringe barrel with an empty barrel of the same size.
 

**NOTE:** If your system is a tank installation, temporarily install a syringe barrel.
  - b. Fill the empty syringe barrel with an appropriate cleaning fluid until it is about 1/3 full.
  - c. Reconnect the syringe barrel adapter.
  - d. Reconnect the barrel adapter quick-connect to the fluid pressure regulator.
4. For optimum cleaning, close the valve and allow the cleaning fluid to soak in the closed valve for approximately 5 minutes.

## Service (continued)

### Clean by Purging with a Cleaning Fluid (continued)

#### To Purge the Valve with Cleaning Fluid

1. Place a paper towel or cup under the valve.
2. If the valve is heated, press the HEATERS icon (🔥) and then press OFF.
3. Press the VALVE icon (🔧).



Switching OFF heater control

### ⚠ CAUTION

**Do not dry cycle the *Pulse* valve!** The ceramic nozzle seat and ball can be damaged if the *Pulse* valve is operated without fluid, causing leakage and a poor seal. Precise dispensing can no longer be guaranteed if this occurs.

4. Press the PURGE icon (🚰) several times to expel any remaining fluid in valve.
5. When the valve starts to eject solvent, press and hold the PURGE icon until you hear air escaping from the nozzle.
6. Repeat the cleaning cycle as many times as needed to completely clean the fluid path. Usually, the higher the viscosity of the fluid, the longer it is necessary to clean.
7. Depressurize the system (refer to step 1 as needed).
8. Disconnect the cleaning fluid supply and restore the dispensing fluid supply.
9. Run the dispensing fluid through the valve until it flows in an undiluted form.
10. Test the operation of the valve. If the valve still does not function properly, continue to the next procedure to clean it manually.



Location of the PURGE button  
(standard Touch controller VALVE screen shown)

## Service (continued)

### Clean by Rebuilding the Fluid Body Assembly

If purging the valve does not resolve clogging or contamination issues, complete the remaining procedures in this section to fully clean the fluid path by rebuilding and cleaning the fluid body assembly.

You will need the following items:

- Pulse* valve cleaning kit (Includes brushes, cotton swabs, mini-reamers, and a magnifying loupe)
- Fluid body cartridge rebuild kit (refer to “Rebuild Kit, Cleaning Kit, and Special Tools” on page 43 for kit part numbers.)
- Safety glasses (not shown)
- Safety gloves (not shown)
- Microscope
- Latch release tool P/N 7361630
- Flat-tip screwdriver
- Crescent wrench
- O-ring insertion tool P/N 7362812
- Bore brush
- Tweezers or other suitable O-ring removal tools

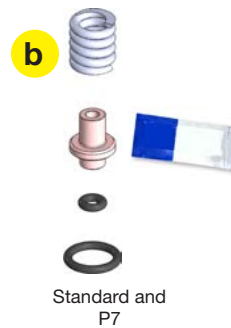

### Prepare for Fluid Body Assembly Rebuild

- If you have not already done so, purge the valve with a cleaning fluid (refer to “Clean by Purging with a Cleaning Fluid” on page 18) to remove as much dispensing fluid from the valve as possible.
- Depressurize the reservoir:
  - (Syringe barrel installations) Disconnect the barrel adapter quick-connect from the fluid pressure regulator.  
OR
  - (Tank installations) Turn off the air pressure to the tank and open the pressure relief valve on the tank lid.
- Stop the fluid supply to the valve:
  - (Syringe barrel installations) Disconnect the syringe barrel adapter from the barrel.  
OR
  - (Tank installations) Disconnect the fluid line fitting from the fluid inlet fitting on the valve.

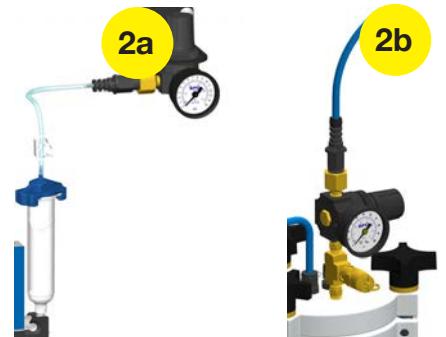

De-pressurize a syringe barrel (2a) or tank (2b) reservoir

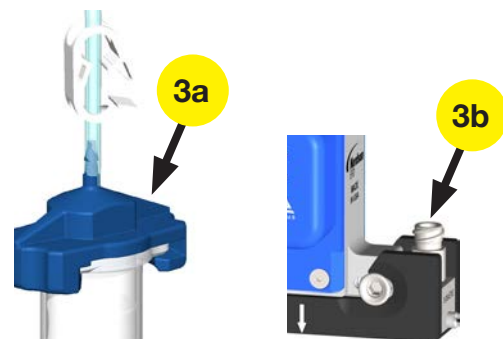





Stop the fluid supply from a syringe barrel (3a) or tank (3b) reservoir

## Service (continued)

### Clean by Rebuilding the Fluid Body Assembly (continued)

#### Prepare for Fluid Body Assembly Rebuild (continued)

- At the *Touch* controller, press the VALVE icon (  ) and then press POWER to switch the valve OFF.
- Press the CHECK (  ) icon to confirm.
- If the valve is heated, press the HEATERS icon (  ) and then press OFF.
- Press HOME (  ) to return to the HOME screen.

#### Remove the Fluid Body Assembly

- If a tip adapter is installed, remove the tip adapter components. Refer to “Install the Tip Adapter (Option)” on page 12 for an illustration of the components for each adapter kit.
- Disconnect the adapter from the syringe barrel.

**NOTE:** For low viscosity fluids, first engage the hose clamp on the syringe adapter assembly to prevent fluid dripping.

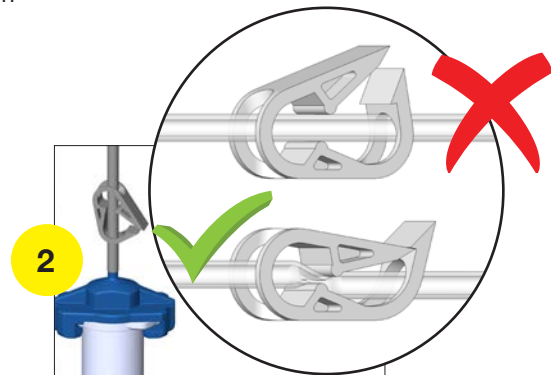

Hose clamp on a syringe barrel adapter assembly

#### CAUTION

To prevent damage to the tappet, remove the syringe barrel before opening the heater body.

- Important:** Remove the syringe barrel from the fluid inlet fitting.



**Important:** To prevent damage to the tappet, remove the syringe barrel BEFORE removing the fluid body assembly.

#### CAUTION

When opening the heater body, be ready to catch the fluid body assembly. Dropping the assembly can damage it.

- Push both sides of the latch pin towards the piezo actuator to open the heater body. This completely frees the fluid body assembly.
- Remove the fluid body assembly from the heater body by pulling up on the fluid inlet fitting.



Latch pin



Fluid inlet fitting

## Service (continued)

### Clean by Rebuilding the Fluid Body Assembly (continued)

#### Disassemble the Fluid Body Assembly and Clean Components

#### ⚠ CAUTION

The fluid body seat, cartridge, and tappet are a precision-calibrated grouping of parts. Interchanging any of the parts with other fluid body assembly parts greatly increases the **possibility of a calibration error when used in a Pulse XP valve** (alarm code b17 020 on the *Touch* controller).

#### ⚠ CAUTION

For PEEK components, use caution when using cleaning tools or brushes to avoid damaging the softer plastic surfaces.

1. Use a wrench to remove the fluid inlet fitting.
2. Use tweezers or the O-ring removal tool to remove the O-ring from the fluid inlet fitting. Clean the O-ring with isopropyl alcohol (IPA) only.
3. Use a flat-tip screwdriver to remove the sealing screw. Do not remove the O-ring from sealing screw. Use IPA to wipe any fluid from end of sealing screw.

#### NOTES:

- Do not use acetone to clean the sealing screw.
  - Nordson EFD recommends replacing the sealing screw O-ring whenever the fluid body assembly is cleaned.
4. Remove the cartridge body by hand.
  5. Remove the O-ring from the base of the cartridge body. Clean the O-ring with IPA only.

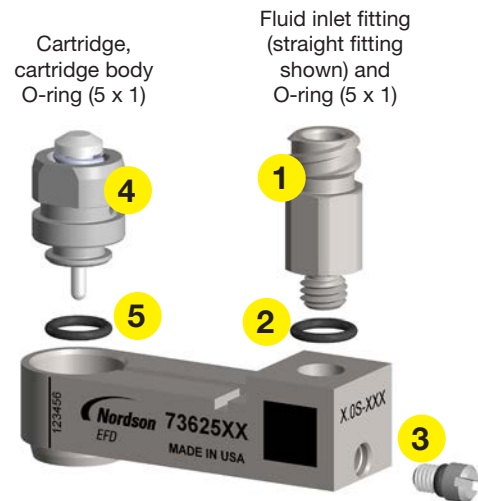

**NOTE: P7 / P30 fluid body assembly not shown.**

Sealing screw and O-ring (brown Viton)

# Service (continued)

## Clean by Rebuilding the Fluid Body Assembly (continued)

### Disassemble the Fluid Body Assembly and Clean Components (continued)

**CAUTION**

For fluid body assemblies with an extended nozzle, do not remove or adjust the extended nozzle component. Doing so can permanently damage the assembly.

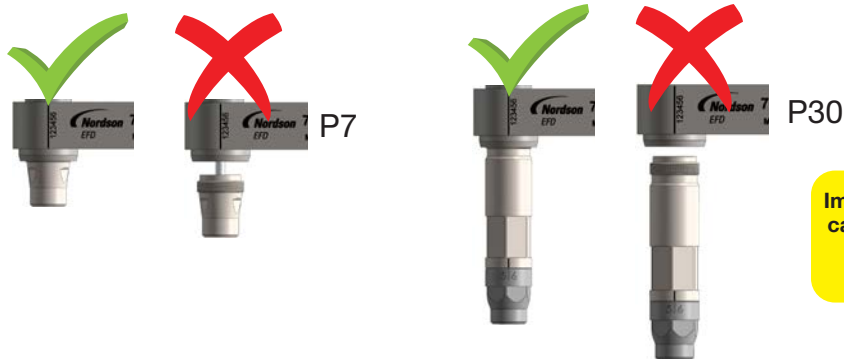

**Important: Extended nozzles are precisely calibrated and factory glued into the fluid body seat. Never remove an extended nozzle from a fluid body assembly.**

**CAUTION**

For P30 extended nozzle fluid body assemblies, do not remove or adjust the nozzle extension. Doing so will permanently damage the assembly.

**Important: Do not remove or adjust a P30 nozzle extension. Doing so will permanently damage the assembly.**

6. **P30 extended nozzle fluid body assemblies only:**

Disassemble the seat holder, O-rings, and guide from the extension. Do not remove the extension.

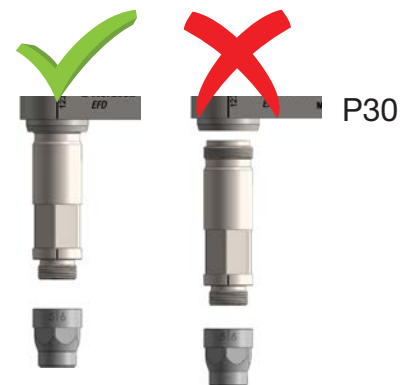
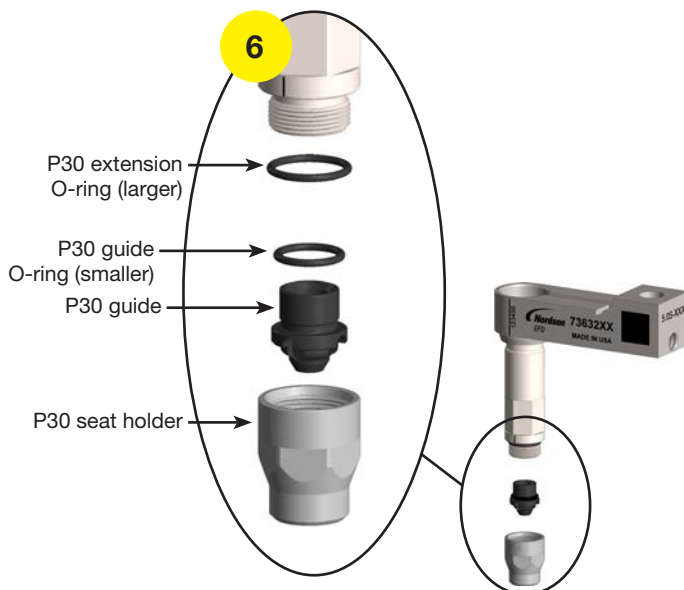

## Service (continued)

### Clean by Rebuilding the Fluid Body Assembly (continued)

#### Disassemble the Fluid Body Assembly and Clean Components (continued)

- Use tweezers to carefully place the fluid body assembly components in an ultrasonic bath. Allow the components to soak for several minutes.

**NOTE:** Cleaning time will be shorter based on the fluid type, especially for watery materials or thin fluids under 1,000 cps. Most other fluids will require longer cleaning time.

#### CAUTION

For PEEK components, use caution when using cleaning tools or brushes to avoid damaging the softer plastic surfaces.

- Use pipe cleaners, bore brushes, Q-tips, or cotton swabs to clean all components.

**NOTE:** Cleaning tools, such as brushes, cotton swabs, mini-reamers, and a magnifying loupe, are included in the *Pulse* valve cleaning kit. Refer to “Rebuild Kit, Cleaning Kit, and Special Tools” on page 43 for the cleaning kit part number.

- Inspect all O-rings for worn spots, cracks, and other defects. Obtain replacements for damaged O-rings.

- Use compressed air to clean lint or residue from the fluid paths.



*Fluid body assembly components to clean: Heater body, fluid inlet fitting, sealing screw, P30 seat holder*

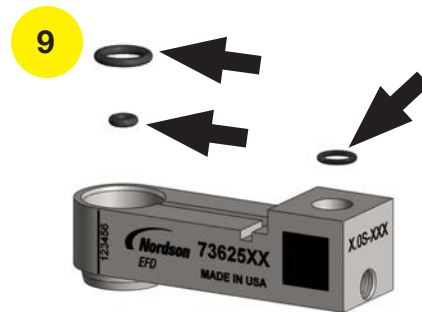

*Location of O-rings*



*Fluid body seat channel cleaning locations*



## Service (continued)

### Clean by Rebuilding the Fluid Body Assembly (continued)

#### Disassemble the Fluid Body Assembly and Clean Components (continued)

#### CAUTION

If too much force is applied with the mini-reamer, the ceramic portion of the nozzle can be damaged (cracked). The reamer can also break, permanently clogging the nozzle.

11. If it is clogged, clean the nozzle by carefully prodding it with a mini-reamer from the cleaning kit.
12. Check the cleanliness with a magnifying loupe or, if available, with a microscope. No lint, particles, residues from dried fluid, or other contaminants may be present in the fluid channel.
 

**NOTE:** Ensure that the ceramic surface and orifice have no residue and are free from any obstructions.
13. Clean the fluid inlet fitting with a cotton swab or cloth and, if necessary, with a solvent, then blow compressed air through the fitting.



*Nozzle cleaning location*



*Fluid inlet fittings*

## Service (continued)

### Clean by Rebuilding the Fluid Body Assembly (continued)

#### Disassemble the Cartridge and Clean Components

**NOTE:** Perform this procedure only if you want to replace the small O-ring located inside the cartridge body.

#### CAUTION

On *Pulse* XP valves, the use of an existing fluid body assembly with a replacement tappet greatly increases the possibility of a calibration error (alarm code b17 020 on the *Touch* controller).

#### CAUTION

Take care not to damage or break the ceramic tappet during disassembly.

1. Disassemble the cartridge components by hand.
2. Turn the cartridge body upside down and use the long end of the O-ring removal tool, held at a slight angle, to push the tappet guide out of the bottom of the cartridge body.

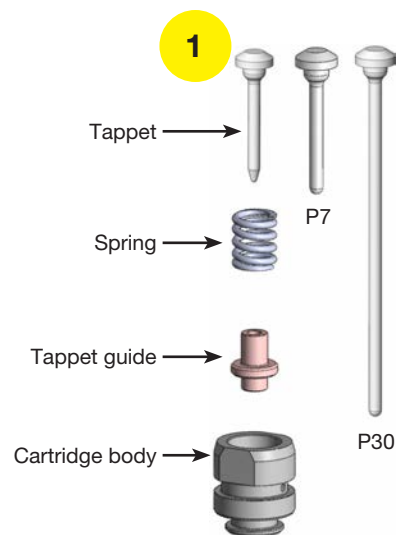

3. Use the O-ring removal tool to pull the small O-ring from the inside of the cartridge body.

**NOTE:** This may require several attempts due the tight tolerance of the cartridge hole.

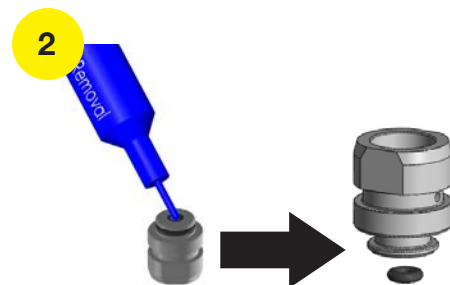

## Service (continued)

### Clean by Rebuilding the Fluid Body Assembly (continued)

#### Disassemble the Cartridge and Clean Components (continued)

#### CAUTION

For PEEK components, use caution when using cleaning tools or brushes to avoid damaging the softer plastic surfaces.

4. Clean the cartridge, spring, tappet, and guide with a brush and cotton swab and, if necessary, with a solvent.
5. Blow compressed air through the cartridge body to clean the inside.
6. Check the cleanliness with a magnifying loupe or, if available, with a microscope. No lint, particles, residues from dried fluid, or other contaminants may be present on the cartridge.

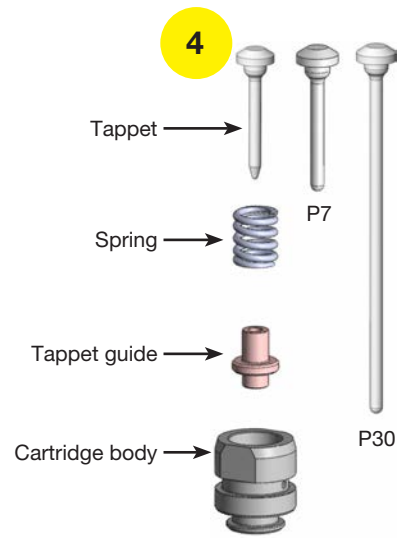

#### Clean the Piezo Actuator

#### CAUTION

Never use dripping wet cloths and do not pour solvents, alcohol, water, or other liquids directly on the valve. In addition, do not submerge the valve into the cleaning agent, as liquid can get into the piezo electromechanical drive area and permanently damage it.

#### CAUTION

Do not use sharp tools to clean the piezo actuator.

When the valve was disassembled, fluid may have contaminated the actuator around the actuator push-rod interface. Clean these areas with a cotton swab, a brush, or a cloth, and if necessary, using small amount of cleaning fluid.



*Piezo actuator cleaning locations  
(do not use sharp tools)*

## Service (continued)

### Clean by Rebuilding the Fluid Body Assembly (continued)

#### Assemble the Fluid Body Assembly

#### ⚠ CAUTION

The fluid body seat, cartridge, and tappet are a precision-calibrated grouping of parts. Interchanging any of the parts with other fluid body assembly parts greatly increases the **possibility of a calibration error when used in a Pulse XP valve** (alarm code b17 020 on the *Touch* controller).

#### ⚠ CAUTION

The fluid body seat, cartridge, and tappet are a precision-calibrated grouping of parts. Interchanging any of the parts with other fluid body assembly parts greatly increases the **possibility of dispensing repeatability errors and degraded performance issues when used in SD or HD Pulse valves**. In extreme cases of mismatched parts, **valve damage can occur**.

#### ⚠ CAUTION

Failure to lubricate the tappet O-ring during fluid body assembly will reduce the amount of stroke available for dispensing. This can prevent the valve from jetting the desired amount of fluid and can cause a calibration error (alarm code b17 020 on the *Touch* controller).

- Lubricate all O-rings with a suitable lubricant.  
**NOTE:** Nordson EFD uses Nye® #865 gel lubricant (P/N 7014917) to lubricate O-rings.
- Install a larger O-ring (5 x 1 mm) in the groove at the bottom of the cartridge body.



- Install the small, black FFKM O-ring as follows:
  - Place the O-ring on the short end of the O-ring insertion tool and hold it in the upright position.
  - Hold the cartridge body upside down over the tool.
  - Use the tool to push the O-ring into the cartridge body. It will stop at the correct location.  
**NOTE:** You will hear a click when the O-ring is in the correct position.
  - Remove the tool and verify that the O-ring is properly installed.

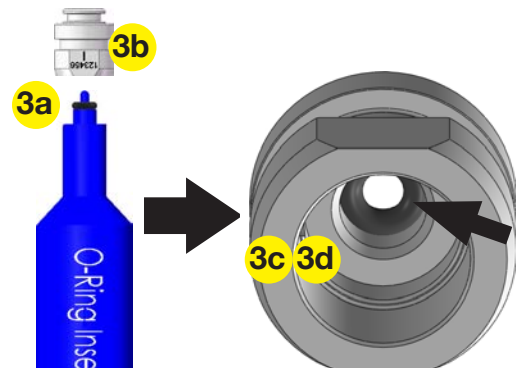

## Service (continued)

### Clean by Rebuilding the Fluid Body Assembly (continued)

#### Assemble the Fluid Body Assembly (continued)

- Use the long end of the insertion tool to install the guide in the cartridge body.

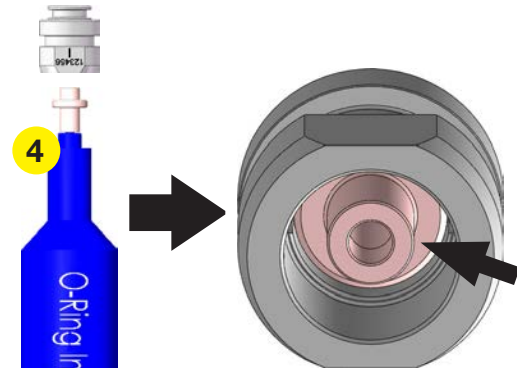

- Use the O-ring insertion tool to install the spring in the cartridge body.

#### **CAUTION**

On *Pμ*lse XP valves, the use of an existing fluid body assembly with a replacement tappet greatly increases the possibility of a calibration error (alarm code b17 020 on the *Touch* controller).

- Lightly lubricate the tappet shaft with a suitable lubricant and carefully install it in the cartridge body.

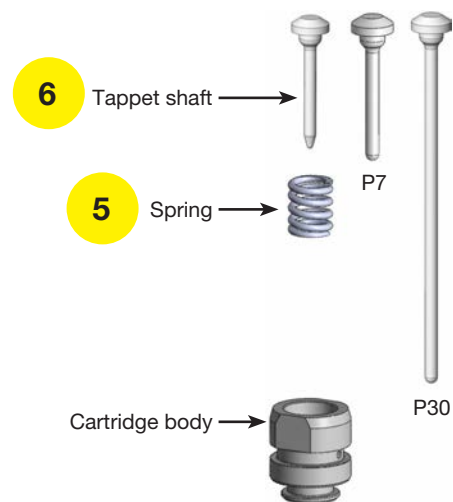

## Service (continued)

### Clean by Rebuilding the Fluid Body Assembly (continued)

#### Assemble the Fluid Body Assembly (continued)

- Thread the sealing screw with the brown Viton O-ring into the fluid body seat and tighten the screw.

**NOTE:** If the sealing screw O-ring is damaged, replace both the screw and O-ring.

#### CAUTION

Take care not to damage or break the ceramic tappet during reassembly.

- Install the assembled cartridge body, guide, and O-ring in the fluid body seat and verify the following:
  - The cartridge body hash mark aligns with the hash mark on the fluid body seat.
  - The serial numbers match.



- Install the fluid inlet fitting and O-ring in the fluid body seat by hand. Use a wrench to tighten it.

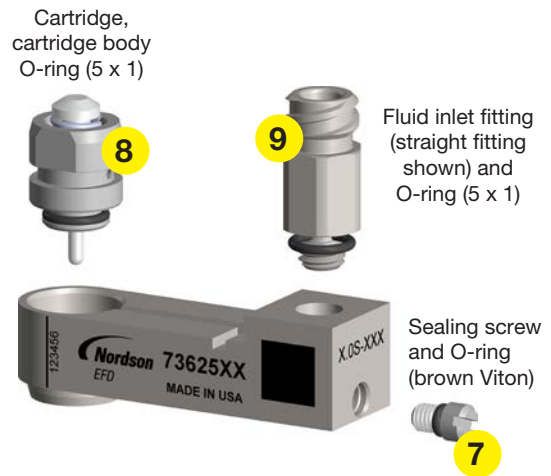

#### CAUTION

The fluid body seat, cartridge, and tappet are a precision-calibrated grouping of parts. Interchanging any of the parts with other fluid body assembly parts greatly increases the **possibility of a calibration error when used in a Pulse XP valve** (alarm code b17 020 on the *Touch* controller).

#### CAUTION

The fluid body seat, cartridge, and tappet are a precision-calibrated grouping of parts. Interchanging any of the parts with other fluid body assembly parts greatly increases the **possibility of dispensing repeatability errors and degraded performance issues when used in SD or HD Pulse valves**. In extreme cases of mismatched parts, valve damage can occur.

## Service (continued)

### Clean by Rebuilding the Fluid Body Assembly (continued)

#### Assemble the Fluid Body Assembly (continued)

10. **P30 extended nozzle fluid body assemblies only:**
  - a. Install the P30 O-rings on the extension and the guide, then assemble the guide and seat holder onto the extension.
  - b. Tighten the seat holder until the hash marks align.

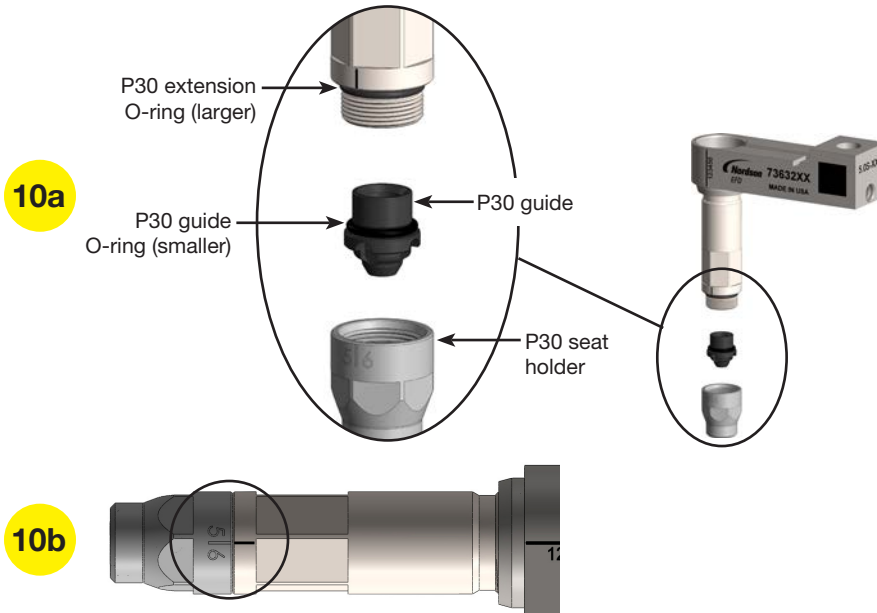

11. Install the fluid body assembly in the valve. Refer to “Fluid Body Assembly Removal and Installation” on page 14 as needed.
12. (If applicable) Install the tip adapter components. Refer to “Install the Tip Adapter (Option)” on page 12 for an illustration of the components for each adapter kit.
13. Reconnect the fluid supply and restore the system to normal operation.

# Accessories

## Tip Adapter Kits

To use the HD *Pulse* actuator for contact dispensing, order the correct adapter kit and other components for your application.

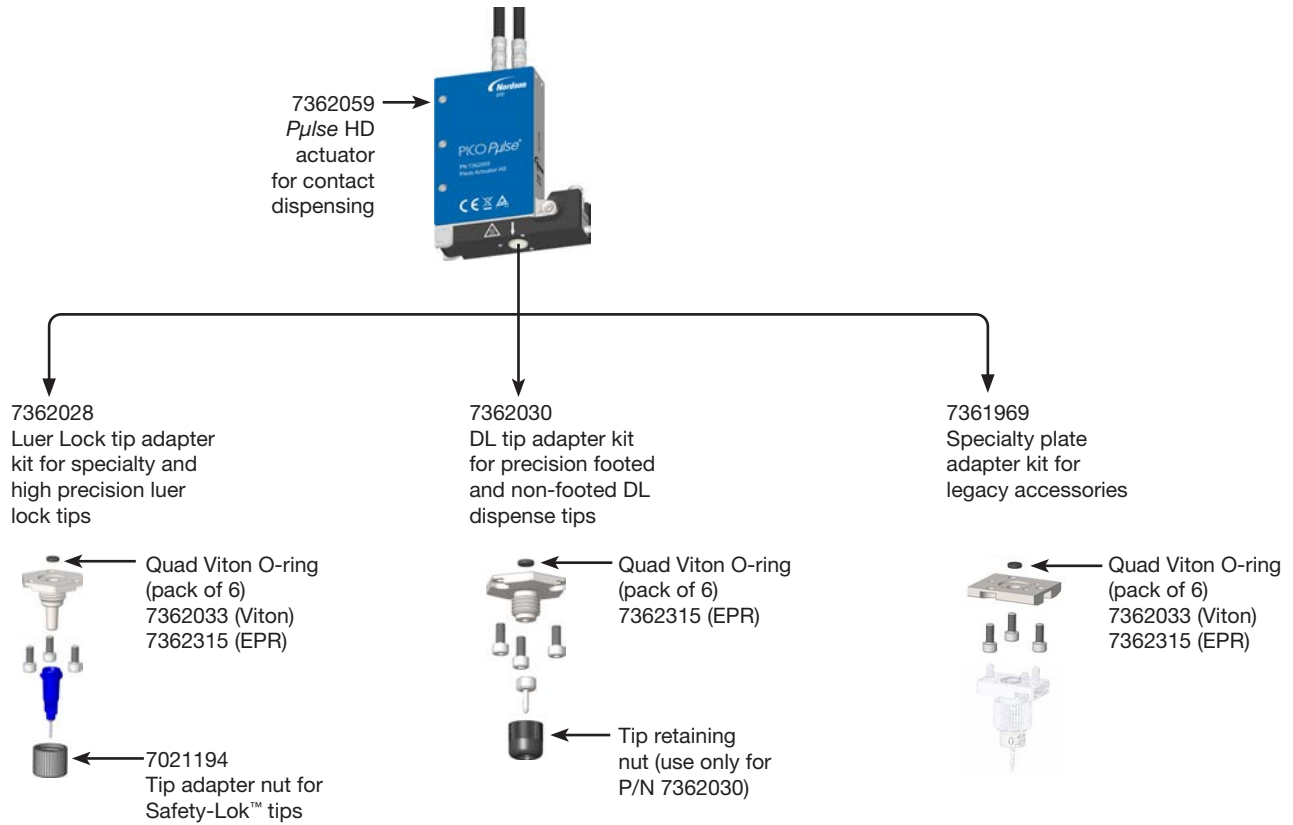



## Accessories (continued)

### Valve Extension Cables for the Standard *Touch* Controller

#### ⚠ CAUTION

Risk of equipment damage. The standard *Touch* controller does not accept extension cables designed for the *Touch* XP controller.

#### ⚠ CAUTION

Do not exceed the maximum extension cable length of 9 m (30 ft). Doing so will adversely affect communication between the valve and the controller.

Part #	Description	Comment
7362085	0.6 m (2.0 ft) valve extension cable set	Includes one each for power and communication 
7361298	2 m (6.6 ft) valve extension cable set	
7361299	6 m (19.7 ft) valve extension cable set	
7361300	9 m (29.5 ft) valve extension cable set	

### Valve Extension Cables for the *Touch* XP Controller

#### ⚠ CAUTION

Risk of equipment damage. The *Touch* XP controller does not accept extension cables designed for the standard *Touch* controller.







#### ⚠ CAUTION

Do not exceed the maximum extension cable length of 9 m (30 ft). Doing so will adversely affect communication between the valve and the controller.

Part #	Description	Comment
7365311	2 m (6.6 ft) valve extension cable set, <i>Touch</i> XP	Includes one each for power and communication 
7365312	6 m (19.7 ft) valve extension cable set, <i>Touch</i> XP	
7365313	9 m (29.5 ft) valve extension cable set, <i>Touch</i> XP	
7365314	12 m (39.4 ft) valve extension cable set, <i>Touch</i> XP	

## Accessories (continued)

### Regulators, Brackets, and High Pressure Adapter Kits

Item	Part #	Description
	7020584	Pressure regulator, 0–7 bar (0–100 psi)
	7020585	Pressure regulator, 0–1 bar (0–15 psi)
	7361815	Universal valve mounting bracket for PRO, EV, and E Series automated dispensing systems
	7361654	Valve mounting bracket for other multi-axis systems and in-line dispensing arms
	7362459	High pressure adapter kit, straight fitting <b>NOTE:</b> High pressure adapter kits allow a material supply pressure to the valve of up to 48 bar (700 psi).
	7362543	High pressure adapter kit, 90° elbow <b>NOTE:</b> High pressure adapter kits allow a material supply pressure to the valve of up to 48 bar (700 psi).
	7361632	Barrel stabilizer for the PICO <i>Pulse</i> valve

Item	Part #	Description
	7361770	HP3cc to M5 fitting adapter kit <b>NOTE:</b> The HP3cc adapter uses a 3cc syringe and produces up to 49 bar (700 psi) of dispensing pressure from 7.0 bar (100 psi) of input.
	7361771	HP5cc to M5 fitting adapter kit <b>NOTE:</b> The HP5cc adapter uses a 5cc syringe and produces up to 28 bar (400 psi) of dispensing pressure from 7.0 bar (100 psi) of input.
	7361772	HP10cc to M5 fitting adapter kit <b>NOTE:</b> The HP10cc adapter uses a larger capacity 10cc syringe and produces up to 28 bar (400 psi) of dispensing pressure from 7.0 bar (100 psi) of input.

## Accessories (continued)

### Fluid Inlet Fittings

**NOTE:** Additional fluid inlet fittings are available. Contact your Nordson EFD representative for information on other fittings.

Fitting	Part #	Description
 PEEK	7362606	Fitting: M5 x female luer lock, straight, stainless steel (includes Viton O-ring)
	7363340	Fitting: M5 x female luer lock, straight, PEEK (includes FFKM O-ring)
	7361303	O-rings: 5 x 1 mm, Viton, brown, 10 pc
	7361681	O-rings: 5 x 1 mm, FFKM, black, 3 pc
	7020669	Fitting: M5 X 3/32" ID barb, stainless steel
	7021919	Fitting: 10-32 UNF X 3/32" barb
	7020671	Fitting: M5 X 1/8" ID barb, stainless steel
	7020673	Fitting: M5 X 1/8" ID barb, stainless steel, elbow
	7361498	Fitting: M5 x 35 mm male-female extension, stainless steel
	7361645	Flat washers, M5 fitting, EPDM, 10 pc (for legacy M5 fittings)
	7361959	Flat washers, M5 fitting, FFKM, 2 pc (for legacy M5 fittings)

## Replacement Parts

**NOTE:** Additional replacement parts are available upon request.

### Piezo Actuator

Part #	Description	Comment
	7361218 Piezo actuator, PICO <i>Pulse</i> , SD (Standard Duty) For non-contact dispensing	Standard duty actuator for general use in non-contact dispensing applications
	7361283 Piezo actuator, PICO <i>Pulse</i> , HD (Heavy Duty) For non-contact dispensing	Heavy duty actuator for high-duty use in non-contact dispensing applications
	7364876 Piezo actuator, PICO <i>Pulse</i> XP (Extreme Precision) For high-performance, non-contact dispensing	<div style="background-color: #e0f0ff; padding: 5px;"> <p><b>⚠ CAUTION</b></p> </div> <p>Use this valve only with the <i>Touch</i> XP controller.</p> <p>High-performance actuator for applications that require extremely precise, repeatable micro-deposits</p>
	7362059 Piezo actuator, PICO <i>Pulse</i> , HD, tip adapter For contact dispensing using a tip adapter	Heavy duty actuator for high-duty use in contact dispensing applications. To use this valve for contact dispensing, order the appropriate tip adapter kit. Refer to “Tip Adapter Kits” on page 32.

## Replacement Parts (continued)

### Fluid Body Assemblies

A wide range of fluid body assemblies are available, summarized in the table below. A Nordson EFD application specialist will help select the best fluid body assembly for optimal jetting performance.

Fluid Body Assembly Type	Recommended Use	Refer To
Standard flat nozzle	Suitable for most fluids and can result in less splashing of the deposit for low- to medium-viscosity fluids	“Flat Nozzle Fluid Body Assemblies” on page 38
PEEK flat nozzle	Suitable for reactive adhesives, such as anaerobics	“PEEK Fluid Body Assemblies (Flat Nozzle Only)” on page 39
Coated / conditioned flat nozzle	For applications requiring tighter tolerances and improved jetting quality	“Flat Nozzle Coated / Conditioned Fluid Body Assemblies” on page 40
Coated / conditioned P7 extended nozzle	For non-contact valves only, P7 nozzles extend 7 mm from the standard flat nozzle length	“P7 Extended Nozzle Coated / Conditioned Fluid Body Assemblies” on page 40
P7 extended nozzle	For non-contact valves only, P7 nozzles extend 7 mm from the standard flat nozzle length	“P7 Extended Nozzle Fluid Body Assemblies” on page 41
P30 extended nozzle	For non-contact valves only, P30 nozzles extend 30 mm from the standard flat nozzle length	“P30 Extended Nozzle Fluid Body Assemblies” on page 41

#### ⚠ CAUTION

The fluid body seat, cartridge, and tappet are a precision-calibrated grouping of parts. Interchanging any of the parts with other fluid body assembly parts greatly increases the **possibility of a calibration error when used in a *Pulse XP valve*** (alarm code b17 020 on the *Touch* controller).

#### ⚠ CAUTION

The fluid body seat, cartridge, and tappet are a precision-calibrated grouping of parts. Interchanging any of the parts with other fluid body assembly parts greatly increases the **possibility of dispensing repeatability errors and degraded performance issues when used in SD or HD *Pulse* valves**. In extreme cases of mismatched parts, **valve damage can occur**.



Fluid body assembly, standard, flat nozzle



Fluid body assembly, PEEK, flat nozzle, with fluid inlet fitting



Fluid body assembly, P7 extended nozzle



Fluid body assembly, P30 extended nozzle

## Replacement Parts (continued)

### Fluid Body Assemblies (continued)

#### ⚠ CAUTION

The fluid body seat, cartridge, and tappet are a precision-calibrated grouping of parts. Interchanging any of the parts with other fluid body assembly parts can compromise valve performance or damage a valve. For details, refer to the cautions on page 37.

### Flat Nozzle Fluid Body Assemblies

Use these fluid body assemblies with *Pulse* non-contact jet valves or *Pulse* contact dispense valves. Standard flat nozzle fluid body assemblies are suitable for most fluids. Two seat types are available:

- Type “D” seat: Standard version is suitable for most fluids and can result in less splashing of the deposit for low- to medium-viscosity fluids.
- Type “E” seat: Recommended for highly viscous / stringing type fluids, it generates more kinetic energy during jetting for better release off nozzle plate and less “tailing.”

Part #	Description	Orifice	Geometry	Ball Size	Comment
7362574	Fluid body assembly	50 µm	E	3.0S	 <ul style="list-style-type: none"> <li>• 3.0S is an 0.8 mm tappet ball end; 5.0S is a 1.5 mm tappet ball end.</li> <li>• A Nordson EFD application specialist will help select the best fluid body assembly for optimal jetting performance.</li> </ul>
7362575	Fluid body assembly	100 µm	D	3.0S	
7362576	Fluid body assembly	200 µm	D	3.0S	
7362577	Fluid body assembly	50 µm	E	5.0S	
7362578	Fluid body assembly	100 µm	E	5.0S	
7362579	Fluid body assembly	150 µm	E	5.0S	
7362580	Fluid body assembly	300 µm	E	5.0S	
7362581	Fluid body assembly	100 µm	D	5.0S	
7362582	Fluid body assembly	150 µm	D	5.0S	
7362583	Fluid body assembly	200 µm	D	5.0S	
7362584	Fluid body assembly	300 µm	D	5.0S	
7362585	Fluid body assembly	400 µm	D	5.0S	
7362586	Fluid body assembly	600 µm	D	5.0S	

## Replacement Parts (continued)

### Fluid Body Assemblies (continued)

#### ⚠ CAUTION

The fluid body seat, cartridge, and tappet are a precision-calibrated grouping of parts. Interchanging any of the parts with other fluid body assembly parts can compromise valve performance or damage a valve. For details, refer to the cautions on page 37.

### PEEK Fluid Body Assemblies (Flat Nozzle Only)

Use these fluid body assemblies with *Pulse* non-contact jet valves or *Pulse* contact dispense valves. PEEK fluid body assemblies prevent curing and clogging when dispensing anaerobic and UV-cure anaerobic adhesives.

Part #	Description	Orifice	Geometry	Ball Size	Comment
7363321	Fluid body assembly, PEEK	50 µm	E	3.0S	 <ul style="list-style-type: none"> <li>• 3.0S is an 0.8 mm tappet ball end; 5.0S is a 1.5 mm tappet ball end.</li> <li>• A Nordson EFD application specialist will help select the best fluid body assembly for optimal jetting performance.</li> </ul>
7363322	Fluid body assembly, PEEK	100 µm	D	3.0S	
7363323	Fluid body assembly, PEEK	200 µm	D	3.0S	
7363324	Fluid body assembly, PEEK	50 µm	E	5.0S	
7363325	Fluid body assembly, PEEK	100 µm	E	5.0S	
7363326	Fluid body assembly, PEEK	150 µm	E	5.0S	
7363327	Fluid body assembly, PEEK	300 µm	E	5.0S	
7363328	Fluid body assembly, PEEK	100 µm	D	5.0S	
7363329	Fluid body assembly, PEEK	150 µm	D	5.0S	
7363330	Fluid body assembly, PEEK	200 µm	D	5.0S	
7363331	Fluid body assembly, PEEK	300 µm	D	5.0S	
7363332	Fluid body assembly, PEEK	400 µm	D	5.0S	
7363333	Fluid body assembly, PEEK	600 µm	D	5.0S	



- 3.0S is an 0.8 mm tappet ball end; 5.0S is a 1.5 mm tappet ball end.
- A Nordson EFD application specialist will help select the best fluid body assembly for optimal jetting performance.

## Replacement Parts (continued)

### Fluid Body Assemblies (continued)

#### CAUTION

The fluid body seat, cartridge, and tappet are a precision-calibrated grouping of parts. Interchanging any of the parts with other fluid body assembly parts can compromise valve performance or damage a valve. For details, refer to the cautions on page 37.

### Flat Nozzle Coated / Conditioned Fluid Body Assemblies

Use these fluid body assemblies with *Pulse* non-contact jet valves or *Pulse* contact dispense valves.

Coated / conditioned fluid body assemblies have a polished / conditioned orifice and special hydrophilic coating that offer the following benefits:

- Improved jetting quality and dot-to-dot consistency
- For UV-cure fluids, reduced formation of micro-bubbles
- For difficult, sticky, or stringy fluids, reduced surface tension of the wetted pathway
- More consistent dispensing performance from one fluid body assembly to another

Part #	Description	Orifice	Geometry	Ball Size	Comment
7364098	Fluid body assembly	20 µm	E	3.0S	 <ul style="list-style-type: none"> <li>• 3.0S is an 0.8 mm tappet ball end; 5.0S is a 1.5 mm tappet ball end.</li> <li>• A Nordson EFD application specialist will help select the best fluid body assembly for optimal jetting performance.</li> </ul>
7364521	Fluid body assembly	75 µm	E	3.0S	
7364523	Fluid body assembly	100 µm	E	3.0S	
7363823	Fluid body assembly	100 µm	D	3.0S	
7364524	Fluid body assembly	150 µm	E	3.0S	
7363665	Fluid body assembly	50 µm	E	3.0S	
7364743	Fluid body assembly	50 µm	E	5.0S	
7363825	Fluid body assembly	100 µm	E	5.0S	
7364550	Fluid body assembly	150 µm	E	5.0S	
7364552	Fluid body assembly	300 µm	E	5.0S	
7364549	Fluid body assembly	200 µm	D	5.0S	

### P7 Extended Nozzle Coated / Conditioned Fluid Body Assemblies

Use these fluid body assemblies only on *Pulse* non-contact jet valves for applications that require tighter tolerances and improved jetting quality.

Part #	Description	Orifice	Geometry	Ball Size	Comment
7364553	Fluid body assembly, P7	75 µm	E	3.0S	 <ul style="list-style-type: none"> <li>• P7 nozzles extend 7 mm from the standard flat nozzle length.</li> <li>• 3.0S is an 0.8 mm tappet ball end; 5.0S is a 1.5 mm tappet ball end.</li> <li>• A Nordson EFD application specialist will help select the best fluid body assembly for optimal jetting performance.</li> </ul>
7365038	Fluid body assembly, P7	100 µm	E	5.0S	
7365039	Fluid body assembly, P7	150 µm	E	5.0S	
7364554	Fluid body assembly, P7	300 µm	E	5.0S	
7365040	Fluid body assembly, P7	200 µm	D	5.0S	



## Replacement Parts (continued)

### Fluid Body Assemblies (continued)

#### ⚠ CAUTION

The fluid body seat, cartridge, and tappet are a precision-calibrated grouping of parts. Interchanging any of the parts with other fluid body assembly parts can compromise valve performance or damage a valve. For details, refer to the cautions on page 37.

### P7 Extended Nozzle Fluid Body Assemblies

Use these fluid body assemblies only on *Pulse* non-contact jet valves.

Part #	Description	Orifice	Geometry	Ball Size	Comment
7362703	Fluid body assembly, P7	50 µm	E	3.0S	 <ul style="list-style-type: none"> <li>• P7 nozzles extend 7 mm from the standard flat nozzle length.</li> <li>• 3.0S is an 0.8 mm tappet ball end; 5.0S is a 1.5 mm tappet ball end.</li> <li>• A Nordson EFD application specialist will help select the best fluid body assembly for optimal jetting performance.</li> </ul>
7362704	Fluid body assembly, P7	100 µm	D	3.0S	
7362705	Fluid body assembly, P7	200 µm	D	3.0S	
7362706	Fluid body assembly, P7	50 µm	E	5.0S	
7362707	Fluid body assembly, P7	100 µm	E	5.0S	
7362708	Fluid body assembly, P7	150 µm	E	5.0S	
7362709	Fluid body assembly, P7	300 µm	E	5.0S	
7362710	Fluid body assembly, P7	100 µm	D	5.0S	
7362711	Fluid body assembly, P7	150 µm	D	5.0S	
7362712	Fluid body assembly, P7	200 µm	D	5.0S	
7362713	Fluid body assembly, P7	300 µm	D	5.0S	
7362714	Fluid body assembly, P7	400 µm	D	5.0S	
7362715	Fluid body assembly, P7	600 µm	D	5.0S	

### P30 Extended Nozzle Fluid Body Assemblies

Use these fluid body assemblies only on *Pulse* non-contact jet valves.

Part #	Description	Orifice	Geometry	Ball Size	Comment
7363238	Fluid body assembly, P30	50 µm	E	5.0S	 <ul style="list-style-type: none"> <li>• P30 nozzles extend 30 mm from the standard flat nozzle length.</li> <li>• 3.0S is an 0.8 mm tappet ball end; 5.0S is a 1.5 mm tappet ball end.</li> <li>• A Nordson EFD application specialist will help select the best fluid body assembly for optimal jetting performance.</li> </ul>
7363239	Fluid body assembly, P30	100 µm	E	5.0S	
7363240	Fluid body assembly, P30	150 µm	E	5.0S	
7363241	Fluid body assembly, P30	300 µm	E	5.0S	
7363242	Fluid body assembly, P30	100 µm	D	5.0S	
7363243	Fluid body assembly, P30	150 µm	D	5.0S	
7363244	Fluid body assembly, P30	200 µm	D	5.0S	
7363245	Fluid body assembly, P30	300 µm	D	5.0S	
7363246	Fluid body assembly, P30	400 µm	D	5.0S	
7363247	Fluid body assembly, P30	600 µm	D	5.0S	

# Replacement Parts (continued)

## Fluid Body Assembly Components

**Tappet (P7 extended nozzles)**  
 7363254 P7, 3.0S ball, 0.8 mm  
 7363255 P7, 3.0S ball, 0.8 mm (12 pack)  
 7363211 P7, 5.0S ball, 1.5 mm  
 7363212 P7, 5.0S ball, 1.5 mm (12 pack)

**Tappet (P30 extended nozzles)**  
 7363425 P30, 5.0S ball, 1.5 mm  
 7363424 P30, 5.0S ball, 1.5 mm (12 pack)

**Tappet (flat nozzles)**  
 7362164 3.0S ball, 0.8 mm  
 7362462 3.0S ball, 0.8 mm (12 pack)  
 7362463 3.0S ball, 0.8 mm (24 pack)  
 7362163 5.0S ball, 1.5 mm  
 7362460 5.0S ball, 1.5 mm (12 pack)  
 7362461 5.0S ball, 1.5 mm (24 pack)

O-ring, 5 x 1 mm  
 7361303 Viton, brown (10 pack)  
 7361681 FFKM, black (3 pack)

O-ring, 1.5 x 1 mm  
 7362701 FFKM, black (10 pack)

Included in rebuild kits:  
 P/N 7362563  
 P/N 7363252  
 P/N 7363339

Cartridge body

**NOTE:** The cartridge body is not replaceable because it is precisely matched to the fluid body seat.

O-ring, 5 x 1 mm  
 7361303 Viton, brown (10 pack)  
 7361681 FFKM, black (3 pack)

**NOTE:** These O-rings are also included in the P30 nozzle O-ring kit.

O-ring, 1.5 x 1 mm  
 7362701 FFKM, black (10 pack)

Sealing screw and O-ring  
 7362346 with brown Viton O-ring (6 pack)  
 7361658 with black FFKM O-ring (6 pack)  
 7363463 PEEK with black FFKM O-ring (1 pc)

**P7**

**NOTE:** The P7 nozzle is not replaceable because it is precisely matched to the fluid body seat.

**P30**

**NOTE:** The P30 extension is not replaceable because it is precisely matched to the fluid body seat.

P30 extension joint  
**(do not remove the extension from this joint)**

7363253 P30 nozzle O-ring kit, includes lubricant and 10 each of:  
 O-ring, 4.29 x 0.61 mm, Viton, black  
 O-ring, 5.31 x 0.61 mm, Viton, black







Also includes the following cartridge O-rings (shown above):  
 O-ring, 1.5 x 1 mm, FFKM, black  
 O-ring, 5 x 1 mm, Viton, brown

P30 guide (Included in P30 rebuild kit P/N 7363252)

## Replacement Parts (continued)

### Rebuild Kit, Cleaning Kit, and Special Tools

The PICO *Pulse* rebuild and cleaning kits contain all the replacement parts and special tools required to safely and effectively service the valve. The optional special tools facilitate fluid body assembly removal and component replacement.

Item	Part #	Description
	7362563 (Standard and P7)	Fluid body cartridge rebuild kit for standard flat nozzle and P7 fluid body assemblies: <ul style="list-style-type: none"> <li>• Spring</li> <li>• Guide</li> <li>• O-ring, 5 x 1 mm, Viton, brown (1)</li> <li>• O-ring, 1.5 x 1 mm, FFKM, black (1)</li> <li>• Nye #865 gel lubricant, 1 g</li> </ul>
	7363252 (P30)	Fluid body cartridge rebuild kit for P30 fluid body assemblies: <ul style="list-style-type: none"> <li>• Spring</li> <li>• Guide</li> <li>• O-ring, 5 x 1 mm, Viton, brown (1)</li> <li>• O-ring, 1.5 x 1 mm, FFKM, black (1)</li> <li>• P30 guide</li> <li>• O-ring, 4.29 x 0.61 mm, Viton, black (1)</li> <li>• O-ring, 5.31 x 0.61 mm, Viton, black (1)</li> <li>• Nye #865 gel lubricant, 1 g</li> </ul>
	7363339 (PEEK)	Fluid body cartridge rebuild kit for PEEK fluid body assemblies: <ul style="list-style-type: none"> <li>• Spring</li> <li>• Guide</li> <li>• O-ring, 5 x 1 mm, Viton, brown (2)</li> <li>• O-ring, 1.5 x 1 mm, FFKM, black (2)</li> <li>• Nye #865 gel lubricant, 1 g</li> </ul>
	7361295	PICO <i>Pulse</i> / fluid body assembly cleaning kit (includes brushes, cotton swabs, mini-reamers, and a magnifying loupe)
	7361630	Latch release tool (opens the piezo actuator heater body; useful for installations with limited side access to the valve)
	7362812	O-ring removal / insertion tool (facilitates removal and installation of the O-ring inside the cartridge)

## Troubleshooting

Use this troubleshooting table to diagnose and correct valve dispensing problems. To avoid the risk of equipment damage or personal injury, depressurize the reservoir and switch OFF the *Touch* controller power before connecting or disconnecting any device or performing any service or troubleshooting work.

**NOTE:** To dispense very small and precise amounts of fluid, the *Pulse* valve has an extremely small opening. This opening can be blocked by the smallest contaminants, which is a common cause of poor dispensing results. However, there are several other possible causes for a non-functioning valve that should be checked first: refer to “How to Determine if Valve Cleaning is Needed” on page 17.

Problem	Possible Cause	Corrective Action
No fluid flow from the valve	No power to the system	Ensure that power is supplied to the system. Verify that the controller display is ON and that the power LED is illuminated (green).
	Loose or disconnected cable or electrical connection	Check all system cable and electrical connections.
	Fluid reservoir empty	Check the fluid reservoir.
	No pressure or very low pressure supply to fluid reservoir	Check the main air pressure.
	Incorrect parameter settings	Check the setup parameters at the controller.
	Valve temperature too low	Check the temperature settings at the controller or PLC.
	Controller alarm	Check the controller display for an alarm code. Refer to the <i>Touch</i> controller operating manual to troubleshoot controller alarms.
	Valve opening clogged or blocked	Clean the fluid body assembly. Refer to “Service” on page 16.
Poor dispensing	Valve opening clogged or blocked or cartridge damaged	Clean the fluid body assembly. Refer to “Service” on page 16.
Residual flow after the valve closes, in which drops or a film forms on the outside of the nozzle	Ball stem not seating or nozzle plate or ball worn/pitted	Clean the fluid body assembly. Inspect the components for damage or wear. Refer to “Service” on page 16.
	Voltage drop in power supply to controller	Refer to the <i>Touch</i> controller operating manual to troubleshoot the controller.
	Controller damaged	Refer to the <i>Touch</i> controller operating manual to troubleshoot the controller.
Nozzle leakage	System power shut off but fluid pressure remains	Maintain power to the system or remove the fluid pressure.
	Damaged fluid body assembly	Inspect the fluid body assembly ball and seat for any pitting or damage. Replace the fluid body assembly as needed. Refer to “Service” on page 16.



## NORDSON EFD ONE YEAR LIMITED WARRANTY

This Nordson EFD product is warranted for one year from the date of purchase to be free from defects in material and workmanship (but not against damage caused by misuse, abrasion, corrosion, negligence, accident, faulty installation, or by dispensing material incompatible with equipment) when the equipment is installed and operated in accordance with factory recommendations and instructions.

Nordson EFD will repair or replace free of charge any defective part upon authorized return of the part prepaid to our factory during the warranty period. The only exceptions are those parts which normally wear and must be replaced routinely, such as, but not limited to, valve diaphragms, seals, valve heads, needles, and nozzles.

In no event shall any liability or obligation of Nordson EFD arising from this warranty exceed the purchase price of the equipment.

Before operation, the user shall determine the suitability of this product for its intended use, and the user assumes all risk and liability whatsoever in connection therewith. Nordson EFD makes no warranty of merchantability or fitness for a particular purpose. In no event shall Nordson EFD be liable for incidental or consequential damages.

This warranty is valid only when oil-free, clean, dry, filtered air is used, where applicable.



For Nordson EFD sales and service in over 40 countries, contact Nordson EFD or go to [www.nordsonefd.com](http://www.nordsonefd.com).

**Global**

800-556-3484; +1-401-431-7000  
[info@nordsonefd.com](mailto:info@nordsonefd.com)

**Europe**

00800 7001 7001  
[infoefd.europe@nordsonefd.com](mailto:infoefd.europe@nordsonefd.com)

**Asia**

China: +86 (21) 3866 9006; [china@nordsonefd.com](mailto:china@nordsonefd.com)  
India: +91 80 4021 3600; [india@nordsonefd.com](mailto:india@nordsonefd.com)  
Japan: +81 03 5762 2760; [japan@nordsonefd.com](mailto:japan@nordsonefd.com)  
Korea: +82-31-736-8321; [korea@nordsonefd.com](mailto:korea@nordsonefd.com)  
SEAsia: +65 6796 9522; [sin-mal@nordsonefd.com](mailto:sin-mal@nordsonefd.com)

Nye is a registered trademark of Nye Lubricants, Inc.  
Viton is a registered trademark of E.I. DuPont.  
The Wave Design is a trademark of Nordson Corporation.  
©2021 Nordson Corporation 7361505 v103121