

Liquidyn V10D Controller

Operating Manual



You have selected a reliable, high-quality dispensing system from Nordson EFD, the world leader in fluid dispensing. The Liquidyn® V10D controller was designed specifically for industrial dispensing and will provide you with years of trouble-free, productive service.

This manual will help you maximize the usefulness of your Liquidyn V10D controller.

Please spend a few minutes to become familiar with the controls and features. Follow our recommended testing procedures. Review the helpful information we have included, which is based on more than 50 years of industrial dispensing experience.

Most questions you will have are answered in this manual. However, if you need assistance, please do not hesitate to contact EFD or your authorized EFD distributor. Detailed contact information is provided on the last page of this document.

The Nordson EFD Pledge

Thank You!

You have just purchased the world's finest precision dispensing equipment.

I want you to know that all of us at Nordson EFD value your business and will do everything in our power to make you a satisfied customer.

If at any time you are not fully satisfied with our equipment or the support provided by your Nordson EFD Product Application Specialist, please contact me personally at 800.556.3484 (US), 401.431.7000 (outside US), or Srini.Subramanian@nordsonefd.com.

I guarantee that we will resolve any problems to your satisfaction.

Thanks again for choosing Nordson EFD.

Srini Subramanian
Srini Subramanian, General Manager

Contents

Contents	3
Introduction	4
Nordson EFD Product Safety Statement	5
Halogenated Hydrocarbon Solvent Hazards	6
High Pressure Fluids	6
Qualified Personnel.....	6
Intended Use	7
Regulations and Approvals.....	7
Personal Safety.....	7
Fire Safety.....	8
Preventive Maintenance	8
Important Disposable Component Safety Information.....	9
Action in the Event of a Malfunction.....	9
Disposal	9
Equipment-Specific Safety Information.....	10
Specifications.....	11
Operating Features.....	12
Front Panel Components.....	12
Rear Panel Components.....	12
Installation	13
Unpack the System Components.....	13
Install the Controller and Test the Operation	14
Setup	14
Install Software and Connect the PC.....	14
View or Change Parameters	15
About the V10D Controller Parameters	16
Parameter Factory Settings	16
Description of Parameters	16
Pulse Time Setting for Jet-Type Valves.....	17
Pulse Time Setting for Dot-Type Valves	17
Use the Push-Button Board to Test the Controller Operation	18
Part Numbers	19
Troubleshooting.....	19
Technical Data.....	20
Input / Output Connector Pin Assignments.....	20
Input / Output Wiring Diagrams.....	21
Power Supply Input Pin Assignments	21

Introduction

The Liquidyn V10D controller is a highly accurate, multi-functional controller for use with Liquidyn micro-dispensing valves. The controller is capable of managing up to four different dispensing programs. Program parameters can be set and adjusted via a 24V USB interface. Once entered into the controller, programs can be retrieved by an I/O signal. The V10D controller is suitable for incorporation into production line machinery.



Nordson EFD Product Safety Statement

WARNING

The safety message that follows has a WARNING level hazard.
Failure to comply could result in death or serious injury.



ELECTRIC SHOCK

Risk of electric shock. Disconnect power before removing covers and / or disconnect, lock out, and tag switches before servicing electrical equipment. If you receive even a slight electrical shock, shut down all equipment immediately. Do not restart the equipment until the problem has been identified and corrected.

CAUTION

The safety messages that follow have a CAUTION level hazard.
Failure to comply may result in minor or moderate injury.



READ MANUAL

Read manual for proper use of this equipment. Follow all safety instructions. Task- and equipment-specific warnings, cautions, and instructions are included in equipment documentation where appropriate. Make sure these instructions and all other equipment documents are accessible to persons operating or servicing equipment.



MAXIMUM AIR PRESSURE

Unless otherwise noted in the product manual, the maximum air input pressure is 7.0 bar (100 psi). Excessive air input pressure may damage the equipment. Air input pressure is intended to be applied through an external air pressure regulator rated for 0 to 7.0 bar (0 to 100 psi).



RELEASE PRESSURE

Release hydraulic and pneumatic pressure before opening, adjusting, or servicing pressurized systems or components.



BURNS

Hot surfaces! Avoid contact with the hot metal surfaces of heated components. If contact can not be avoided, wear heat-protective gloves and clothing when working around heated equipment. Failure to avoid contact with hot metal surfaces can result in personal injury.

Nordson EFD Product Safety Statement (continued)

Halogenated Hydrocarbon Solvent Hazards

Do not use halogenated hydrocarbon solvents in a pressurized system that contains aluminum components. Under pressure, these solvents can react with aluminum and explode, causing injury, death, or property damage. Halogenated hydrocarbon solvents contain one or more of the following elements.

Element	Symbol	Prefix
Fluorine	F	“Fluoro-”
Chlorine	Cl	“Chloro-”
Bromine	Br	“Bromo-”
Iodine	I	“Iodo-”

Check the Safety Data Sheet (SDS) or contact your material supplier for more information. If you must use halogenated hydrocarbon solvents, contact your EFD representative for compatible EFD components.

High Pressure Fluids

High pressure fluids, unless they are safely contained, are extremely hazardous. Always release fluid pressure before adjusting or servicing high pressure equipment. A jet of high pressure fluid can cut like a knife and cause serious bodily injury, amputation, or death. Fluids penetrating the skin can also cause toxic poisoning.

WARNING

Any injury caused by high pressure liquid can be serious. If you are injured or even suspect an injury:

- Go to an emergency room immediately.
- Tell the doctor that you suspect an injection injury.
- Show the doctor the following note.
- Tell the doctor what kind of material you were dispensing.

Medical Alert — Airless Spray Wounds: Note to Physician

Injection in the skin is a serious traumatic injury. It is important to treat the injury surgically as soon as possible. Do not delay treatment to research toxicity. Toxicity is a concern with some exotic coatings injected directly into the bloodstream.

Qualified Personnel

Equipment owners are responsible for making sure that EFD equipment is installed, operated, and serviced by qualified personnel. Qualified personnel are those employees or contractors who are trained to safely perform their assigned tasks. They are familiar with all relevant safety rules and regulations and are physically capable of performing their assigned tasks.

Nordson EFD Product Safety Statement (continued)

Intended Use

Use of EFD equipment in ways other than those described in the documentation supplied with the equipment may result in injury to persons or damage to property. Some examples of unintended use of equipment include:

- Using incompatible materials.
- Making unauthorized modifications.
- Removing or bypassing safety guards or interlocks.
- Using incompatible or damaged parts.
- Using unapproved auxiliary equipment.
- Operating equipment in excess of maximum ratings.
- Operating equipment in an explosive atmosphere.

Regulations and Approvals

Make sure all equipment is rated and approved for the environment in which it is used. Any approvals obtained for Nordson EFD equipment will be voided if instructions for installation, operation, and service are not followed. If the equipment is used in a manner not specified by Nordson EFD, the protection provided by the equipment may be impaired.

Personal Safety

To prevent injury, follow these instructions:

- Do not operate or service equipment unless you are qualified.
- Do not operate equipment unless safety guards, doors, and covers are intact and automatic interlocks are operating properly. Do not bypass or disarm any safety devices.
- Keep clear of moving equipment. Before adjusting or servicing moving equipment, shut off the power supply and wait until the equipment comes to a complete stop. Lock out power and secure the equipment to prevent unexpected movement.
- Make sure spray areas and other work areas are adequately ventilated.
- When using a syringe barrel, always keep the dispensing end of the tip pointing towards the work and away from the body or face. Store syringe barrels with the tip pointing down when they are not in use.
- Obtain and read the Safety Data Sheet (SDS) for all materials used. Follow the manufacturer's instructions for safe handling and use of materials and use recommended personal protection devices.
- Be aware of less-obvious dangers in the workplace that often cannot be completely eliminated, such as hot surfaces, sharp edges, energized electrical circuits, and moving parts that cannot be enclosed or otherwise guarded for practical reasons.
- Know where emergency stop buttons, shutoff valves, and fire extinguishers are located.
- Wear hearing protection to protect against hearing loss that can be caused by exposure to vacuum exhaust port noise over long periods of time.

Nordson EFD Product Safety Statement (continued)

Fire Safety

To prevent a fire or explosion, follow these instructions:

- Shut down all equipment immediately if you notice static sparking or arcing. Do not restart the equipment until the cause has been identified and corrected.
- Do not smoke, weld, grind, or use open flames where flammable materials are being used or stored.
- Do not heat materials to temperatures above those recommended by the manufacturer. Make sure heat monitoring and limiting devices are working properly.
- Provide adequate ventilation to prevent dangerous concentrations of volatile particles or vapors. Refer to local codes or the SDS for guidance.
- Do not disconnect live electrical circuits when working with flammable materials. Shut off power at a disconnect switch first to prevent sparking.
- Know where emergency stop buttons, shutoff valves, and fire extinguishers are located.

Preventive Maintenance

As part of maintaining continuous trouble-free use of this product, Nordson EFD recommends the following simple preventive maintenance checks:

- Periodically inspect tube-to-fitting connections for proper fit. Secure as necessary.
- Check tubing for cracks and contamination. Replace tubing as necessary.
- Check all wiring connections for looseness. Tighten as necessary.
- Clean: If a front panel requires cleaning, use a clean, soft, damp rag with a mild detergent cleaner. **DO NOT USE** strong solvents (MEK, acetone, THF, etc.) as they will damage the front panel material.
- Maintain: Use only a clean, dry air supply to the unit. The equipment does not require any other regular maintenance.
- Test: Verify the operation of features and the performance of equipment using the appropriate sections of this manual. Return faulty or defective units to Nordson EFD for replacement.
- Use only replacement parts that are designed for use with the original equipment. Contact your Nordson EFD representative for information and advice.

Nordson EFD Product Safety Statement (continued)

Important Disposable Component Safety Information

All Nordson EFD disposable components, including syringe barrels, cartridges, pistons, tip caps, end caps, and dispense tips, are precision engineered for one-time use. Attempting to clean and re-use components will compromise dispensing accuracy and may increase the risk of personal injury.

Always wear appropriate protective equipment and clothing suitable for your dispensing application and adhere to the following guidelines:

- Do not heat syringe barrels or cartridges to a temperature greater than 38° C (100° F).
- Dispose of components according to local regulations after one-time use.
- Do not clean components with strong solvents (MEK, acetone, THF, etc.).
- Clean cartridge retainer systems and barrel loaders with mild detergents only.
- To prevent fluid waste, use Nordson EFD SmoothFlow™ pistons.

Action in the Event of a Malfunction

If a system or any equipment in a system malfunctions, shut off the system immediately and perform the following steps:

1. Disconnect and lock out system electrical power. If using hydraulic and pneumatic shutoff valves, close and relieve pressure.
2. For Nordson EFD air-powered dispensers, remove the syringe barrel from the adapter assembly. For Nordson EFD electro-mechanical dispensers, slowly unscrew the barrel retainer and remove the barrel from the actuator.
3. Identify the reason for the malfunction and correct it before restarting the system.

Disposal

Dispose of equipment and materials used in operation and servicing according to local codes.

Nordson EFD Product Safety Statement (continued)

Equipment-Specific Safety Information

The following safety information is specific to the Liquidyn V10D controller.

CAUTION

Do not dry cycle the valve! The valve can be damaged if it is operated without fluid, causing leakage and a poor seal. Precise dispensing can no longer be guaranteed if this occurs.

General

- Before use, read the complete operating instructions and all safety instructions to ensure safe and correct usage.
- Observe all safety instructions.

Intended Use

- The micro-dispensing system is for indoor use only.
- Do not use the micro-dispensing system in an explosive atmosphere or with explosive materials.
- Do not expose the controller to direct heat sources.

Fluid Compatibility

- Use only for the micro-dispensing of high- to low-viscosity fluids or pastes.
- Ensure that all fluid carrying parts and sealings are resistant to the dispensing material used.

Operating Conditions

- Do not subject the valve needle to force, knocks, or impact.
- Avoid long shutdown periods with the system switched on.
- Do not operate the valve in a dry condition (without dispensing material).

Controller Operation

- Operate the controller only when it is in good working order and in accordance with the operating conditions specified above.
- Operate the controller only when all safety devices and safety components are installed correctly and fully functional.

Controller Faults

In the event of a fault in the power supply and / or damage to the electrical equipment, do the following:

1. Immediately switch OFF the controller and lock out electrical power to the controller.
2. Determine the cause of the fault condition and immediately rectify.

Specifications

NOTE: Specifications and technical details are subject to change without prior notification.

Item	Specification
Cabinet size	105W x 68H x 203D mm (4.1W x 2.7H x 8.0D")
Weight	0.9 kg (2.0 lb)
Cycle rate	Up to 280Hz
Time range	2–10,000 ms
Electrical power input	24 VDC, 0.3 Amp minimum
Electrical input connector	Lumberg KFFV70
External power adapter	AC/DC power supply and power cord: 100–240 VAC, 50/60Hz, 1.4 Amp input; 24 VDC, 2.5 Amp, 60 W maximum output
Internal voltage	24 VDC, 5 VDC
Feedback circuit	0 VDC (logical low) 24 VDC (logical high)
Housing	Aluminum
Ambient operating conditions	Temperature: 0–40° C (32–104° F) Humidity: 10–80% Storage temperature: -25–60° C (-13–140° F)
Product classification	IP40 Protection Class III
Approvals	CE, RoHS, WEEE, China RoHS

RoHS标准相关声明 (China RoHS Hazardous Material Declaration)

产品名称 Part Name	有害物质及元素 Toxic or Hazardous Substances and Elements					
	铅 Lead (Pb)	汞 Mercury (Hg)	镉 Cadmium (Cd)	六价铬 Hexavalent Chromium (Cr6)	多溴联苯 Polybrominated Biphenyls (PBB)	多溴联苯醚 Polybrominated Diphenyl Ethers (PBDE)
外部接口 External Electrical Connectors	X	0	0	0	0	0
<p>0: 表示该产品所含有的危险成分或有害物质含量依照EIP-A, EIP-B, EIP-C 的标准低于SJ/T11363-2006 限定要求。 Indicates that this toxic or hazardous substance contained in all the homogeneous materials for this part, according to EIP-A, EIP-B, EIP-C is below the limit requirement in SJ/T11363-2006.</p> <p>X: 表示该产品所含有的危险成分或有害物质含量依照EIP-A, EIP-B, EIP-C 的标准高于SJ/T11363-2006 限定要求。 Indicates that this toxic or hazardous substance contained in all the homogeneous materials for this part, according to EIP-A, EIP-B, EIP-C is above the limit requirement in SJ/T11363-2006.</p>						

WEEE Directive



This equipment is regulated by the European Union under WEEE Directive (2012/19/EU). Refer to www.nordsonefd.com/WEEE for information about how to properly dispose of this equipment.

Operating Features

Front Panel Components



Status Signal	Description
Pulse Jet Valve	Valve cycle indication — green LED
Pulse Air Valve	Air nozzle cycle indication (optional) — green LED
Power ON	Operating readiness — red LED

Rear Panel Components

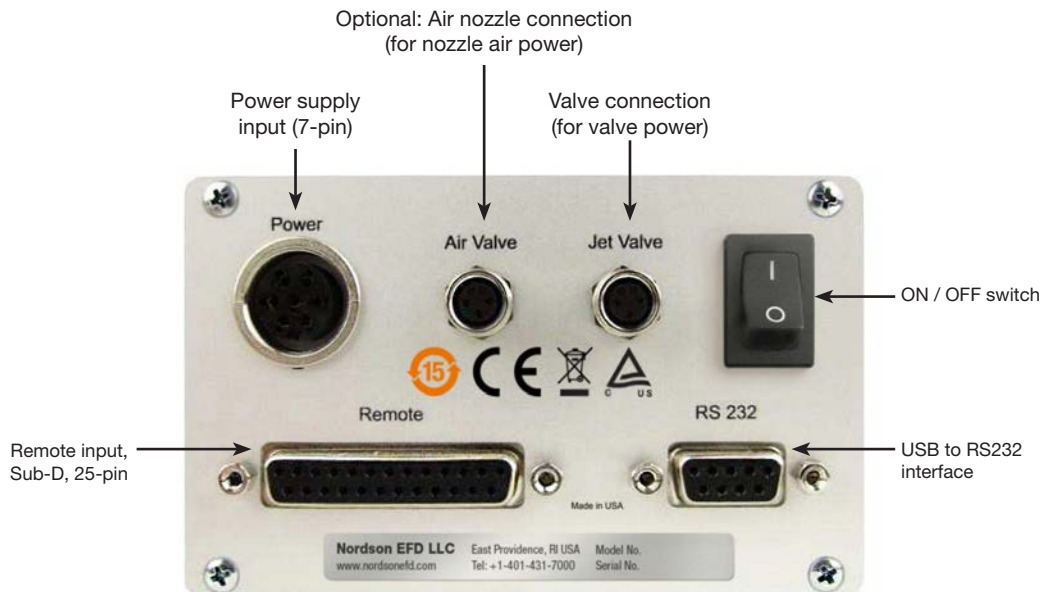

Port	Description
Power	7-pin socket (from binder), power supply connection
Air Valve	3-pin M8, nozzle air power input cable connection
Jet Valve	3-pin M8, valve power input cable connection
RS 232	9-pin Sub-D (COM) to USB cable connection
Remote	25-Pin Sub-D — remote input / output connection

Installation

Use this section in tandem with any other system component operating manuals to install all components of the system.

Unpack the System Components

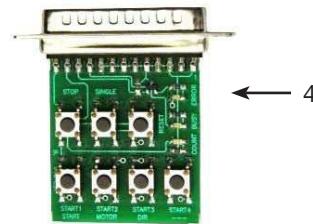

- 1 Liquidyn V10D controller
- 2 Power cord and power supply (external power adapter)
- 3 USB-to-RS 232 (COM) adapter cable and driver software
- 4 Push-button board for testing

Install the Controller and Test the Operation

1. Use supplied power cord and power supply to connect power to the Power input port on the back of the V10D controller.

NOTE: An optional 24 VDC power cable is available. Refer to "Part Numbers" on page 19 for the cable part number and connection information.
2. Connect the dispensing valve to the controller using the cable supplied with the valve.
3. Switch on the controller using the ON/OFF switch. The red Power LED illuminates.
4. Start dispensing using the factory settings, or adjust the dispensing parameters using the V10D software:
 - Refer to "Parameter Factory Settings" on page 16 for the factory settings.
 - Refer to "Setup" on page 14 to change parameters as needed for your application.
5. As needed, use the push-button board to test the controller operation. Refer to "Use the Push-Button Board to Test the Controller Operation" on page 18.

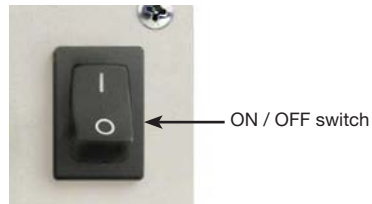

Setup

NOTES:

- The push-button board can be used for testing. Refer to "Use the Push-Button Board to Test the Controller Operation" on page 18.
- For serial operation, or to incorporate the controller into a special machine, I/O signals from a PLC can be connected to the Remote input, instead of to the push-button board. For the Remote input pin assignment, refer to "Input / Output Connector Pin Assignments" on page 20.

Install Software and Connect the PC

1. Install the driver software for the USB-to-RS232 adapter cable on a personal computer (PC).
2. Go to www.nordsonefd.com/LiquidynV10D to obtain the V10D software.
3. Install the V10D software on the same PC used in step 1.
4. Run the "Liquidyn_V10D_Setup" installer and follow the instructions.
5. Connect the USB-to-RS232 adapter cable to the V10D controller and to the PC.



Continue to "View or Change Parameters" on page 15 to view or change the V10D controller settings using the V10D software.

Setup (continued)

View or Change Parameters

1. Open the V10 Digital Software.
2. Select the desired language: English or German.
3. Select the COM Port to which USB-to-RS 232 adapter cable is connected.
NOTE: If you cannot determine the COM port, refer to "Setting Up the COM Port" below.
4. Click SHOW CURRENT VALUES.
5. Observe the current settings under the CURRENT VALUES column.
6. Enter changes under the NEW VALUES column. Refer to "About the V10D Controller Parameters" on page 16 for information about parameters.
7. Click ENTER NEW VALUES to save the changes.
NOTE: The controller can store 4 programs, each with different parameter settings.
8. When programming is complete, disconnect the USB-to-RS 232 adapter cable from the controller.

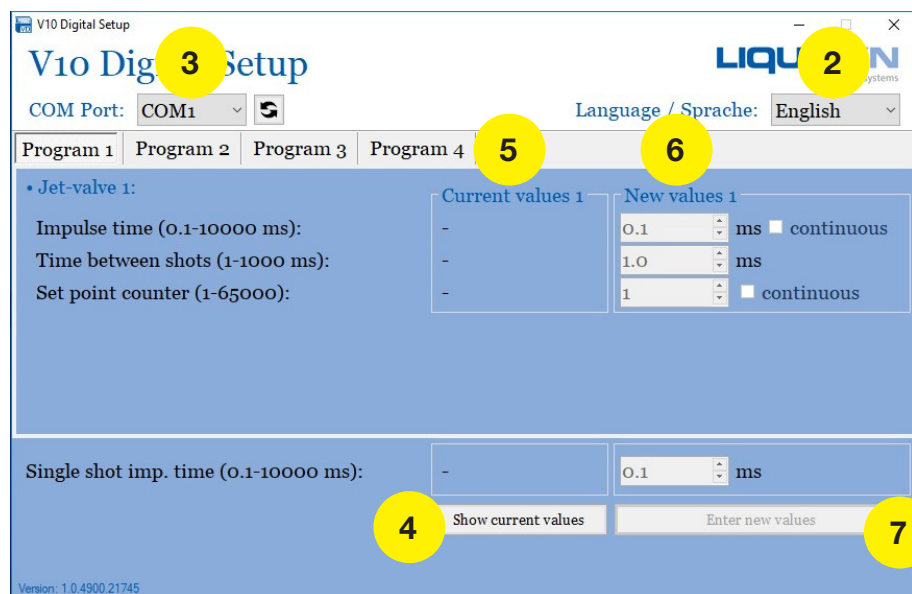

Setting Up the COM Port

If it is unclear which COM-Port should be chosen, proceed as follows:

1. Enter the Windows system control (Start -> System control).
2. Select Hardware and Sound.
3. Open Devices and Printers > Device Manager.
4. Open Inputs (COM & LPT). It should read "Prolific USB-to-Serial Com Port" and in brackets "COM" with a number. Select this COM port.

Setup (continued)

About the V10D Controller Parameters

Refer to "View or Change Parameters" on page 15 to adjust parameters using the V10D software.

Parameter Factory Settings

Program	1	2	3	4
Impulse time (Pulse Time)	2 ms	2 ms	2 ms	2 ms
Time between shots	1000 ms	100 ms	20 ms	10 ms
Set point counter	10	10	10	10
Single shot imp. time	2 ms	2 ms	2 ms	2 ms

Description of Parameters

Parameter	Range of Settings	Description
Impulse time (Pulse Time)	0.1 to 10,000 ms	<ul style="list-style-type: none"> Corresponds to the electrical actuation time of the valve. Must be adapted to the corresponding valve type (jet-type or dot-type). <p>NOTE: Refer to "Pulse Time Setting for Jet-Type Valves" on page 17 or "Pulse Time Setting for Dot-Type Valves" on page 17 as applicable for your valves.</p> <ul style="list-style-type: none"> When "Continuous" is disabled (not checked), the valve remains open until the program is stopped.
Time between shots	1 to 1,000 ms	<ul style="list-style-type: none"> Sets the length of the pause between the shots at one dispensing position, for as long as several shots are applied.
Set point counter	1 to 65,000	<ul style="list-style-type: none"> Sets the number of shots. When "Continuous" is checked, the valve keeps dispensing until the program stops.
Single shot imp. time	0.1 to 10,000 ms	<ul style="list-style-type: none"> Sets how long the air nozzle remains open after the valve is closed.

Setup (continued)

Pulse Time Setting for Jet-Type Valves

- For jet-type valves, the pneumatically actuated dispensing needle remains open as long as it is triggered. The Pulse Time directly affects the dispensing volume.
- The Pulse Time of jet-type valves can be set within a range of 2 to 10,000 ms. If the Pulse Time is below 2 ms, correct valve operation cannot be guaranteed.

Oscillogram (Valve Output) for Jet-Type Valves

NOTE: The Pulse Time of jet-type valves corresponds to the opening time of the valve. The dispensing volume can be adjusted by adjusting the Pulse Time.

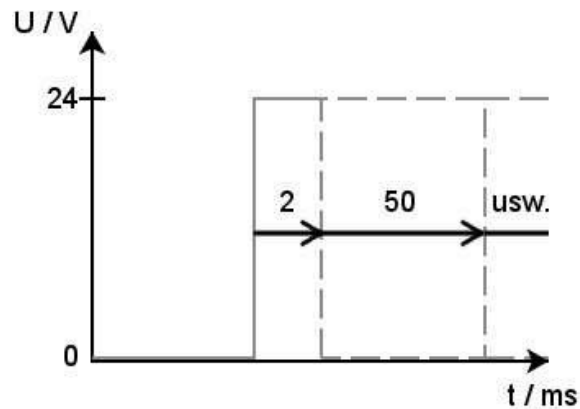

Pulse Time Setting for Dot-Type Valves

- The Pulse Time must be 2 ms before placing the valve into operation.
- Do not change the Pulse Time for Dot-type valves.

The Pulse Time for dot-type valves must be 2 ms. With dot-type valves, Pulse Time adjustments do not affect the dispensing volume, but they can cause poor dispensing results.

Oscillogram (Valve Output) for Dot-Type Valves

NOTE: The Pulse Time of dot-type valves does not correspond to the opening time of the valve. The opening time of the valve depends on the settings for working pressure and the set screw and is usually shorter than the electrical actuation time (Pulse Time) by a factor of 5 to 10.

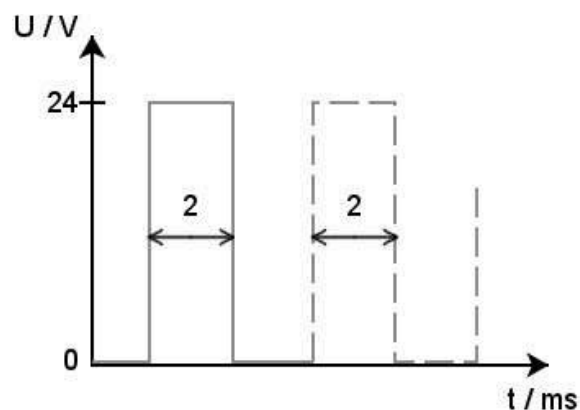

Setup (continued)

Use the Push-Button Board to Test the Controller Operation

The V10D controller functions can be tested using the push-button board.

NOTE: For serial operation, or to incorporate the controller into a special machine, I/O signals from a PLC can be connected to the Remote input, instead of to the push-button board. For the Remote input pin assignment, refer to "Input / Output Connector Pin Assignments" on page 20.

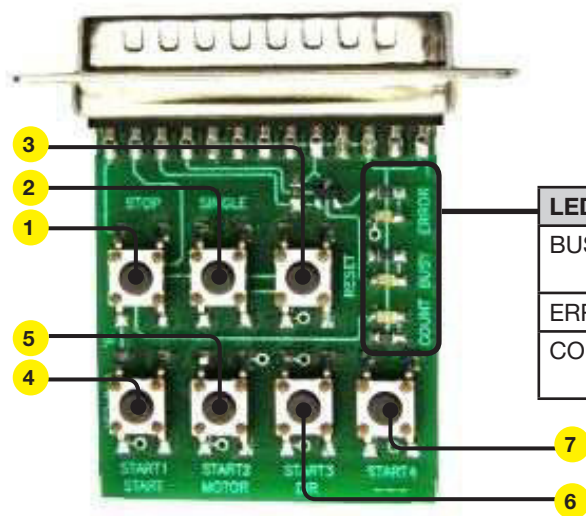
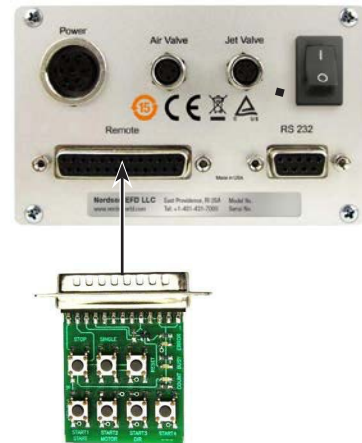

1. Connect the push-button board to the Remote input on the back of the controller.
2. Press the buttons on the push-button board to test the controller functions. Refer to the tables provided below.



LED	Indication	Description
BUSY	Illuminates	Controller running a program
ERROR	Illuminates	Error
COUNTER	Flashes	Square-shaped pulse, 8 ms/shot

Item	Push Button	Action
1	STOP	Stops the currently running sequence of steps /shots. Pushing the Start Button re-starts the sequence of shots at the same position.
2	SINGLE SHOT	Dispenses individual shots (dots) from the valve.
3	RESET	Resets the currently running program to zero.
4	START1 (Start)	Runs Program 1. The valve dispenses as programmed.
5	START2 (Motor)	Runs Program 2. The valve dispenses as programmed.
6	START3 (DIR)	Runs Program 3. The valve dispenses as programmed.
7	START4 (---)	Runs Program 4. The valve dispenses as programmed.

Part Numbers

Part #	Description	Item
7825163	Liquidyn V10D controller (includes power cord and power supply, P/N 7825484)	
7825484	Power cord and power supply (external power adapter), 24V, 3.75 Amp	
7825175	Power cable, banana plug, 24V, 2 m NOTE: This cable can be used to connect power to the controller in place of the supplied power cord. Note the pin assignments: <ul style="list-style-type: none"> • Red = +24 VDC • Black = Mass 	

Troubleshooting

If the V10D controller is incorporated into a PLC and the valve is not dispensing properly, check all parameters using the push-button board (refer to "Use the Push-Button Board to Test the Controller Operation" on page 18). If the parameters cannot be checked with the push-button board, contact your Nordson EFD representative.

Technical Data

Input / Output Connector Pin Assignments

- All inputs and outputs are electrically separated.
- The controller is actuated by a 24V I/O signal at the Remote input. The controller reacts to every square-shaped pulse (raising edge at least 2 ms.)
- Refer to "Use the Push-Button Board to Test the Controller Operation" on page 18 to test the Remote I/O using the push-button board.

Pin	Direction	Assignment	Description
1	Output	+24 VDC Out; max. 0.25 A	Operating voltage
2	NC	Not assigned	
3	Input	+ START1	Starts Program 1
4	Input	+ STOP	Stops
5	Input	+ SINGLE SHOT	Single shot mode, valve
6	Input	+ RESET	Counter / reset steps
7	Input	+ START2	Starts Program 2
8	Input	+ START3	Starts Program 3
9	Input	+ START4	Starts Program 4
10	Output	+ BUSY	Busy
11	Output	+ ERROR	Error notice (ON = No error)
12	Output	+ COUNTER	Counter
13	Output	- 24V (GND) Out	Operating voltage
14	NC	Not assigned	
15	Input	- START1	
16	Input	- STOP	
17	Input	- SINGLE	
18	Input	- RESET	
19	Input	- START2	
20	Input	- START3	
21	Input	- START4	
22	Output	- BUSY	
23	Output	- ERROR	
24	Output	- COUNTER	
25	NC	Not assigned	

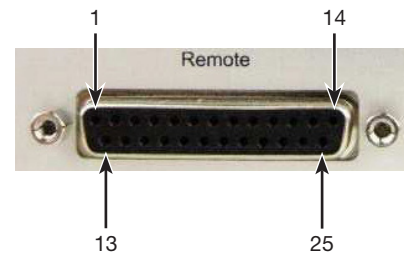

Technical Data (continued)

Input / Output Wiring Diagrams

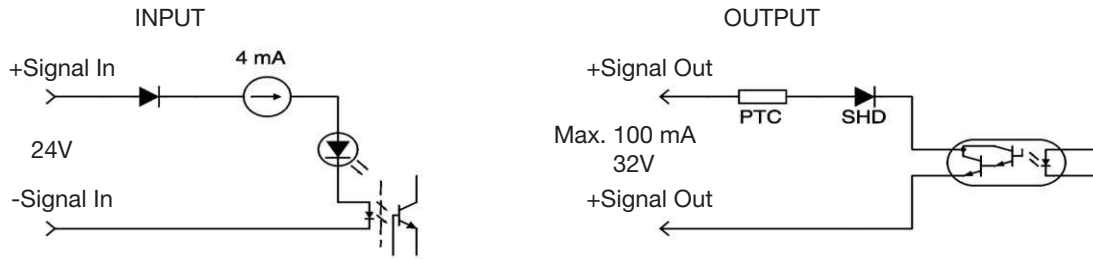

Power Supply Input Pin Assignments

Pin	Assignment	Description
1	NC	Not assigned
2	+24 VDC	Operating voltage
3	NC	Not assigned
4	NC	Not assigned
5	-24V (GND)	Operating voltage (ground)
6	NC	Not assigned
7	NC	Not assigned

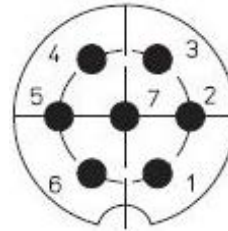

NORDSON EFD ONE YEAR LIMITED WARRANTY

Nordson EFD products are warranted for one year from date of purchase to be free from defects in material and workmanship (but not against damage caused by misuse, abrasion, corrosion, negligence, accident, faulty installation or by dispensing material incompatible with equipment) when the equipment is installed and operated in accordance with factory recommendations and instructions. Nordson EFD will repair or replace free of charge any part of the equipment thus found to be defective, on authorized return of the part prepaid to our factory during the warranty period. In no event shall any liability or obligation of Nordson EFD arising from this warranty exceed the purchase price of the equipment. This warranty is valid only when oil-free, clean, dry, filtered air is used.

Nordson EFD makes no warranty of merchantability or fitness for a particular purpose. In no event shall Nordson EFD be liable for incidental or consequential damages.



For Nordson EFD sales and service in over 40 countries, contact Nordson EFD or go to www.nordsonefd.com.

Global

East Providence, RI USA
800-556-3484; +1-401-431-7000
info@nordsonefd.com

Europe

Dunstable, Bedfordshire, UK
0800 585733; +44 (0) 1582 666334
europe@nordsonefd.com

Asia

China: +86 (21) 3866 9006; china@nordsonefd.com
India: +91 80 4021 3600; india@nordsonefd.com
Japan: +81 03 5762 2760; japan@nordsonefd.com
Korea: +82-31-736-8321; korea@nordsonefd.com
SEAsia: +65 6796 9522; sin-mal@nordsonefd.com

The Wave Design is a trademark of Nordson Corporation.
©2019 Nordson Corporation 7364063 v022819