

Liquidyn V200 Controller

Operating Manual



You have selected a reliable, high-quality dispensing system from Nordson EFD, the world leader in fluid dispensing. The Liquidyn® V200 controller was designed specifically for industrial dispensing and will provide you with years of trouble-free, productive service.

This manual will help you maximize the usefulness of your Liquidyn V200 controller.

Please spend a few minutes to become familiar with the controls and features. Follow our recommended testing procedures. Review the helpful information we have included, which is based on more than 50 years of industrial dispensing experience.

Most questions you will have are answered in this manual. However, if you need assistance, please do not hesitate to contact EFD or your authorized EFD distributor. Detailed contact information is provided on the last page of this document.

The Nordson EFD Pledge

Thank You!

You have just purchased the world's finest precision dispensing equipment.

I want you to know that all of us at Nordson EFD value your business and will do everything in our power to make you a satisfied customer.

If at any time you are not fully satisfied with our equipment or the support provided by your Nordson EFD Product Application Specialist, please contact me personally at 800.556.3484 (US), 401.431.7000 (outside US), or Srini.Subramanian@nordsonefd.com.

I guarantee that we will resolve any problems to your satisfaction.

Thanks again for choosing Nordson EFD.

Srini Subramanian
Srini Subramanian, General Manager

Contents

Contents	3
Introduction	4
Nordson EFD Product Safety Statement	5
Halogenated Hydrocarbon Solvent Hazards	6
High Pressure Fluids	6
Qualified Personnel	6
Intended Use	7
Regulations and Approvals	7
Personal Safety	7
Fire Safety	8
Preventive Maintenance	8
Important Disposable Component Safety Information	9
Action in the Event of a Malfunction	9
Disposal	9
Equipment-Specific Safety Information	10
Specifications	11
Operating Features	12
Front Panel Components	12
Rear Panel Components	12
Installation	13
Unpack the System Components	13
Make the System Connections	14
Set Up and Test the System	15
Set Up Remote Control (Optional)	16
Operation	16
Control Panel Overview	16
Default Display	16
Control Panel Keys	17
Navigating the Controller Menus	18
Parameters and System Settings	18
Flowchart of Menu Structure	20
Selecting a Program	22
Viewing or Changing Parameters	23
Pulse Time	23
Frequency	25
Setpoint Counter	26
Heater	27
Viewing or Changing System Settings	28
Language	28
Heater Cable Length	29
IN-STOP Behavior	30
Shoot Release	31
Digital Input	32
Viewing the Software and Hardware Versions	34
Part Number	35
Replacement Parts	35
Troubleshooting	36
Air Pressure Problems	36
Electrical Problems	36
Technical Data	37
Input Connector Pin Assignments	37
Input / Output Circuit Wiring Diagrams	38
Wiring Diagrams for Connecting the V200 to a PLC	39
High Level Signal	39
Low Level Signal	40

Introduction

The Liquidyn V200 controller provides an easy-to-use interface for controlling Liquidyn P-Jet Series or P-Dot Series micro-dispensing pneumatic jet valves, allowing operators to quickly determine the best baseline settings for optimal dispensing results. The Liquidyn V200 controller can store up to four sets of programmed parameters. Each set of parameters is identified by a program number. Peripheral devices, such as a heater and air pressure regulator, are already integrated. The controller is ideal for use in a laboratory or at a manual work station.



Nordson EFD Product Safety Statement

WARNING

The safety message that follows has a WARNING level hazard.
Failure to comply could result in death or serious injury.



ELECTRIC SHOCK

Risk of electric shock. Disconnect power before removing covers and / or disconnect, lock out, and tag switches before servicing electrical equipment. If you receive even a slight electrical shock, shut down all equipment immediately. Do not restart the equipment until the problem has been identified and corrected.

CAUTION

The safety messages that follow have a CAUTION level hazard.
Failure to comply may result in minor or moderate injury.



READ MANUAL

Read manual for proper use of this equipment. Follow all safety instructions. Task- and equipment-specific warnings, cautions, and instructions are included in equipment documentation where appropriate. Make sure these instructions and all other equipment documents are accessible to persons operating or servicing equipment.



MAXIMUM AIR PRESSURE

Unless otherwise noted in the product manual, the maximum air input pressure is 7.0 bar (100 psi). Excessive air input pressure may damage the equipment. Air input pressure is intended to be applied through an external air pressure regulator rated for 0 to 7.0 bar (0 to 100 psi).



RELEASE PRESSURE

Release hydraulic and pneumatic pressure before opening, adjusting, or servicing pressurized systems or components.



BURNS

Hot surfaces! Avoid contact with the hot metal surfaces of heated components. If contact can not be avoided, wear heat-protective gloves and clothing when working around heated equipment. Failure to avoid contact with hot metal surfaces can result in personal injury.

Nordson EFD Product Safety Statement (continued)

Halogenated Hydrocarbon Solvent Hazards

Do not use halogenated hydrocarbon solvents in a pressurized system that contains aluminum components. Under pressure, these solvents can react with aluminum and explode, causing injury, death, or property damage. Halogenated hydrocarbon solvents contain one or more of the following elements.

Element	Symbol	Prefix
Fluorine	F	“Fluoro-”
Chlorine	Cl	“Chloro-”
Bromine	Br	“Bromo-”
Iodine	I	“Iodo-”

Check the Safety Data Sheet (SDS) or contact your material supplier for more information. If you must use halogenated hydrocarbon solvents, contact your EFD representative for compatible EFD components.

High Pressure Fluids

High pressure fluids, unless they are safely contained, are extremely hazardous. Always release fluid pressure before adjusting or servicing high pressure equipment. A jet of high pressure fluid can cut like a knife and cause serious bodily injury, amputation, or death. Fluids penetrating the skin can also cause toxic poisoning.

WARNING

Any injury caused by high pressure liquid can be serious. If you are injured or even suspect an injury:

- Go to an emergency room immediately.
- Tell the doctor that you suspect an injection injury.
- Show the doctor the following note.
- Tell the doctor what kind of material you were dispensing.

Medical Alert — Airless Spray Wounds: Note to Physician

Injection in the skin is a serious traumatic injury. It is important to treat the injury surgically as soon as possible. Do not delay treatment to research toxicity. Toxicity is a concern with some exotic coatings injected directly into the bloodstream.

Qualified Personnel

Equipment owners are responsible for making sure that EFD equipment is installed, operated, and serviced by qualified personnel. Qualified personnel are those employees or contractors who are trained to safely perform their assigned tasks. They are familiar with all relevant safety rules and regulations and are physically capable of performing their assigned tasks.

Nordson EFD Product Safety Statement (continued)

Intended Use

Use of EFD equipment in ways other than those described in the documentation supplied with the equipment may result in injury to persons or damage to property. Some examples of unintended use of equipment include:

- Using incompatible materials.
- Making unauthorized modifications.
- Removing or bypassing safety guards or interlocks.
- Using incompatible or damaged parts.
- Using unapproved auxiliary equipment.
- Operating equipment in excess of maximum ratings.
- Operating equipment in an explosive atmosphere.

Regulations and Approvals

Make sure all equipment is rated and approved for the environment in which it is used. Any approvals obtained for Nordson EFD equipment will be voided if instructions for installation, operation, and service are not followed. If the equipment is used in a manner not specified by Nordson EFD, the protection provided by the equipment may be impaired.

Personal Safety

To prevent injury, follow these instructions:

- Do not operate or service equipment unless you are qualified.
- Do not operate equipment unless safety guards, doors, and covers are intact and automatic interlocks are operating properly. Do not bypass or disarm any safety devices.
- Keep clear of moving equipment. Before adjusting or servicing moving equipment, shut off the power supply and wait until the equipment comes to a complete stop. Lock out power and secure the equipment to prevent unexpected movement.
- Make sure spray areas and other work areas are adequately ventilated.
- When using a syringe barrel, always keep the dispensing end of the tip pointing towards the work and away from the body or face. Store syringe barrels with the tip pointing down when they are not in use.
- Obtain and read the Safety Data Sheet (SDS) for all materials used. Follow the manufacturer's instructions for safe handling and use of materials and use recommended personal protection devices.
- Be aware of less-obvious dangers in the workplace that often cannot be completely eliminated, such as hot surfaces, sharp edges, energized electrical circuits, and moving parts that cannot be enclosed or otherwise guarded for practical reasons.
- Know where emergency stop buttons, shutoff valves, and fire extinguishers are located.
- Wear hearing protection to protect against hearing loss that can be caused by exposure to vacuum exhaust port noise over long periods of time.

Nordson EFD Product Safety Statement (continued)

Fire Safety

To prevent a fire or explosion, follow these instructions:

- Shut down all equipment immediately if you notice static sparking or arcing. Do not restart the equipment until the cause has been identified and corrected.
- Do not smoke, weld, grind, or use open flames where flammable materials are being used or stored.
- Do not heat materials to temperatures above those recommended by the manufacturer. Make sure heat monitoring and limiting devices are working properly.
- Provide adequate ventilation to prevent dangerous concentrations of volatile particles or vapors. Refer to local codes or the SDS for guidance.
- Do not disconnect live electrical circuits when working with flammable materials. Shut off power at a disconnect switch first to prevent sparking.
- Know where emergency stop buttons, shutoff valves, and fire extinguishers are located.

Preventive Maintenance

As part of maintaining continuous trouble-free use of this product, Nordson EFD recommends the following simple preventive maintenance checks:

- Periodically inspect tube-to-fitting connections for proper fit. Secure as necessary.
- Check tubing for cracks and contamination. Replace tubing as necessary.
- Check all wiring connections for looseness. Tighten as necessary.
- Clean: If a front panel requires cleaning, use a clean, soft, damp rag with a mild detergent cleaner. DO NOT USE strong solvents (MEK, acetone, THF, etc.) as they will damage the front panel material.
- Maintain: Use only a clean, dry air supply to the unit. The equipment does not require any other regular maintenance.
- Test: Verify the operation of features and the performance of equipment using the appropriate sections of this manual. Return faulty or defective units to Nordson EFD for replacement.
- Use only replacement parts that are designed for use with the original equipment. Contact your Nordson EFD representative for information and advice.

Nordson EFD Product Safety Statement (continued)

Important Disposable Component Safety Information

All Nordson EFD disposable components, including syringe barrels, cartridges, pistons, tip caps, end caps, and dispense tips, are precision engineered for one-time use. Attempting to clean and re-use components will compromise dispensing accuracy and may increase the risk of personal injury.

Always wear appropriate protective equipment and clothing suitable for your dispensing application and adhere to the following guidelines:

- Do not heat syringe barrels or cartridges to a temperature greater than 38° C (100° F).
- Dispose of components according to local regulations after one-time use.
- Do not clean components with strong solvents (MEK, acetone, THF, etc.).
- Clean cartridge retainer systems and barrel loaders with mild detergents only.
- To prevent fluid waste, use Nordson EFD SmoothFlow™ pistons.

Action in the Event of a Malfunction

If a system or any equipment in a system malfunctions, shut off the system immediately and perform the following steps:

1. Disconnect and lock out system electrical power. If using hydraulic and pneumatic shutoff valves, close and relieve pressure.
2. For Nordson EFD air-powered dispensers, remove the syringe barrel from the adapter assembly. For Nordson EFD electro-mechanical dispensers, slowly unscrew the barrel retainer and remove the barrel from the actuator.
3. Identify the reason for the malfunction and correct it before restarting the system.

Disposal

Dispose of equipment and materials used in operation and servicing according to local codes.

Nordson EFD Product Safety Statement (continued)

Equipment-Specific Safety Information

The following safety information is specific to the Liquidyn V200 controller.

CAUTION

Do not dry cycle the valve! The valve can be damaged if it is operated without fluid, causing leakage and a poor seal. Precise dispensing can no longer be guaranteed if this occurs.

General

- Before use, read the complete operating instructions and all safety instructions to ensure safe and correct usage.
- Observe all safety instructions.

Intended Use

- The micro-dispensing system is for indoor use only.
- Do not use the micro-dispensing system in an explosive atmosphere or with explosive materials.
- Do not expose the controller to direct heat sources.

Fluid Compatibility

- Use only for the micro-dispensing of high- to low-viscosity fluids or pastes.
- Ensure that all fluid carrying parts and sealings are resistant to the dispensing material used.

Operating Conditions

- Operate heaters only within the approved temperature range. Refer to "Specifications" on page 11.
- Use only heaters that are distributed by Nordson EFD specifically for this micro-dispensing valve.
- Do not subject the valve needle to force, knocks, or impact.
- Avoid long shutdown periods with the system switched on.
- Do not operate the valve in a dry condition (without dispensing material).

Controller Operation

- Operate the controller only when it is in good working order and in accordance with the operating conditions specified above.
- Operate the controller only when all safety devices and safety components are installed correctly and fully functional.

Controller Faults

In the event of a fault in the power supply and / or damage to the electrical equipment, do the following:

1. Immediately switch OFF the controller and lock out electrical power to the controller.
2. Disconnect the controller from the pneumatic supply.
3. Determine the cause of the fault condition and immediately rectify.

Specifications

NOTE: Specifications and technical details are subject to change without prior notification.

Item	Specification
Cabinet size	45.0W x 12.5H x 25.0D cm (19" rack 3HE) (17.72W x 4.92H x 9.84D")
Weight	5.5 kg (12.1 lb)
Cycle rate	Up to 280Hz
Time range	2–9,999 ms
Electrical power input	24 VDC, 2.5 Amp minimum
Electrical input connector	Lumberg KFV70
External power adapter	AC/DC power supply and power cord: 100–240 VAC, 50/60Hz, 1.4 Amp input; 24 VDC, 2.5 Amp, 60 W maximum output
Internal voltage	24 VDC, 5 VDC
Feedback circuit	0 VDC (logical low) 24 VDC (logical high)
Input air pressure	6.2–10.3 bar (90–150 psi) NOTE: The compressed air supply must be oil free and filtered to 40 µm.
Temperature control	0–90° C (32–194° F) NOTE: This is a user-programmable setting to control the temperature of the optional nozzle heater.
Ambient operating conditions	Temperature: 0–40° C (32–104° F) Humidity: 10–80% Storage temperature: -25–60° C (-13–140° F)
Product classification	IP40 Protection Class III
Approvals	CE, TÜV, RoHS, WEEE, China RoHS

RoHS标准相关声明 (China RoHS Hazardous Material Declaration)

产品名称 Part Name	有害物质及元素 Toxic or Hazardous Substances and Elements					
	铅 Lead (Pb)	汞 Mercury (Hg)	镉 Cadmium (Cd)	六价铬 Hexavalent Chromium (Cr6)	多溴联苯 Polybrominated Biphenyls (PBB)	多溴联苯醚 Polybrominated Diphenyl Ethers (PBDE)
外部接口 External Electrical Connectors	X	0	0	0	0	0
<p>0: 表示该产品所含有的危险成分或有害物质含量依照EIP-A, EIP-B, EIP-C 的标准低于SJ/T11363-2006 限定要求。 Indicates that this toxic or hazardous substance contained in all the homogeneous materials for this part, according to EIP-A, EIP-B, EIP-C is below the limit requirement in SJ/T11363-2006.</p> <p>X: 表示该产品所含有的危险成分或有害物质含量依照EIP-A, EIP-B, EIP-C 的标准高于SJ/T11363-2006 限定要求。 Indicates that this toxic or hazardous substance contained in all the homogeneous materials for this part, according to EIP-A, EIP-B, EIP-C is above the limit requirement in SJ/T11363-2006.</p>						

WEEE Directive



This equipment is regulated by the European Union under WEEE Directive (2012/19/EU). Refer to www.nordsonefd.com/WEEE for information about how to properly dispose of this equipment.

Operating Features

Front Panel Components

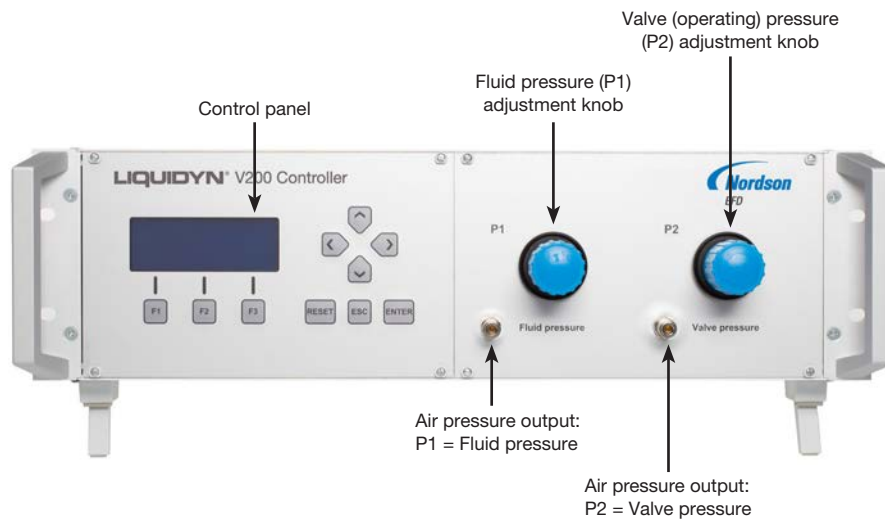

Rear Panel Components

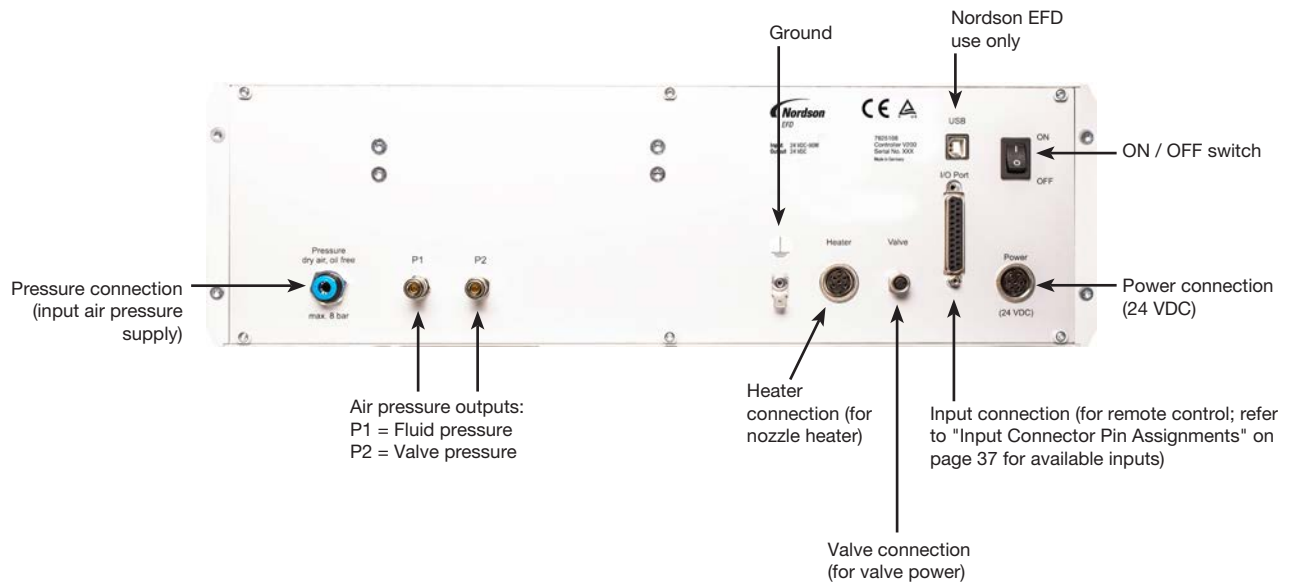

Port	Description
Heater	4-pin M5 / M8 heater cable connection
Valve	3-pin M8 valve cable connection
I/O Port	25-pin input connection (for remote control)
Power	7-pin power connection

Installation

Use this section in tandem with any other system component operating manuals to install all components of the system.

Unpack the System Components



- 1 Liquidyn V200 controller
- 2 Power cord and power supply (external power adapter)
- 3 Air pressure tubing for P1: 4 mm outside diameter (OD) x 90 cm length (L), with connector plug
- 4 Air pressure tubing for P2: 6 mm OD x 90 cm L, with connector plug

(Not shown)

Air pressure tubing for the air pressure supply: 6 mm OD x 300 cm L

Installation (continued)

Make the System Connections

All connections are located on the rear panel of the controller. The step numbers below correspond to the diagram call-outs.

1. Ensure that the valve is properly installed and supplied with fluid. Refer to the valve manual for valve installation instructions.
2. Connect the power cord and power supply to the POWER connection to supply the controller with 24 VDC power.
3. Connect a ground wire to the ground screw and attach the opposite end of the ground wire to a permanent earth ground.
4. Connect the valve power cable to the VALVE connection.
5. **Optional:** Connect the nozzle heater cable to the HEATER connection. Refer to the valve manual for nozzle heater installation instructions.

6. Connect an oil-free, 40 μm filtered compressed air supply to the PRESSURE connection.

WARNING

Spiral-type air supply tubing can cause injury. Use pneumatic tubing for high pressure operation.

CAUTION

Ensure that the P1 and P2 connections are correct. If the connections are swapped, the valve will not operate.

7. Use 4 mm OD tubing to connect the P1 fluid pressure air supply to the fluid supply.
8. Use 6 mm OD (minimum) tubing to connect the P2 valve (operating) pressure air supply to the valve.

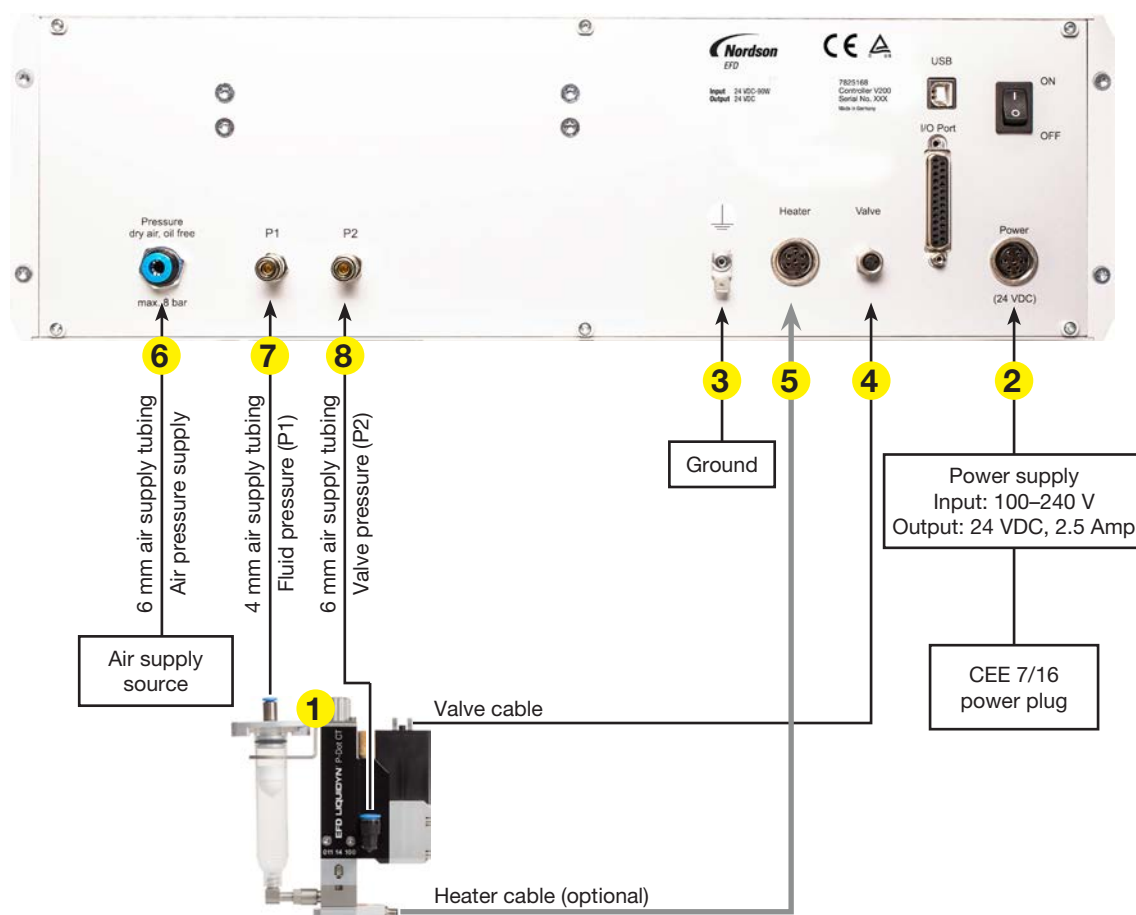

Installation (continued)

Set Up and Test the System

⚠ CAUTION

Do not dry cycle the valve! The valve can be damaged if it is operated without fluid, causing leakage and a poor seal. Precise dispensing can no longer be guaranteed if this occurs.

1. Ensure that material is present in the syringe barrel.
2. Switch ON the controller.

⚠ CAUTION

The micro-dispensing valves are designed for a specific maximum amount of operating pressure (refer to the specifications in the applicable valve operating manual). Exceeding the maximum operating pressure can damage the valve, causing premature failure.

3. Ensure that the controller has a sufficient air supply [6.2–10.3 bar (90–150 psi) input pressure].
4. Set the following:
 - Fluid pressure (P1 Fluid pressure knob).
 - Valve operating pressure (P2 Valve pressure knob).
 - Pulse Time (refer to "Pulse Time" on page 23).
 - Frequency (refer to "Frequency" on page 25).
 - **Optional:** Nozzle heater temperature (refer to "Heater" on page 27).

NOTES:

- To adjust a pressure regulator, first unlock the regulator by pulling out its adjustment knob on the front of the controller.
 - If you know the recommended system settings, make adjustments accordingly. If you do not know any system settings or if you are dispensing a new or untried material, empirically determine the settings. Refer to "Operation" on page 16 in this manual and to the settings recommendations in the applicable valve operating manual.
5. Press F3 (SHOOT) to test dispensing. The valve cable bulb (located inside the plug) illuminates for every dispense cycle.
 6. Make adjustments as needed until the desired dispensing pattern is obtained.



Installation (continued)

Set Up Remote Control (Optional)

To control the Liquidyn V200 controller directly via a higher-level control system, connect inputs to the I/O Port connection. The I/O Port connection also provides outputs for system monitoring. Refer to the following sections for additional information on inputs / outputs:

- "Input Connector Pin Assignments" on page 37.
- "Input / Output Circuit Wiring Diagrams" on page 38.
- "Wiring Diagrams for Connecting the V200 to a PLC" on page 39

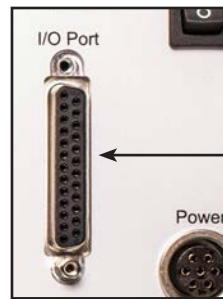

Input connection (for remote control; refer to "Input Connector Pin Assignments" on page 37 for available inputs)

Operation

Control Panel Overview

Use the control panel to enter valve settings and to control valve dispensing. An explanation of each control panel key is provided under "Control Panel Keys" on page 17.

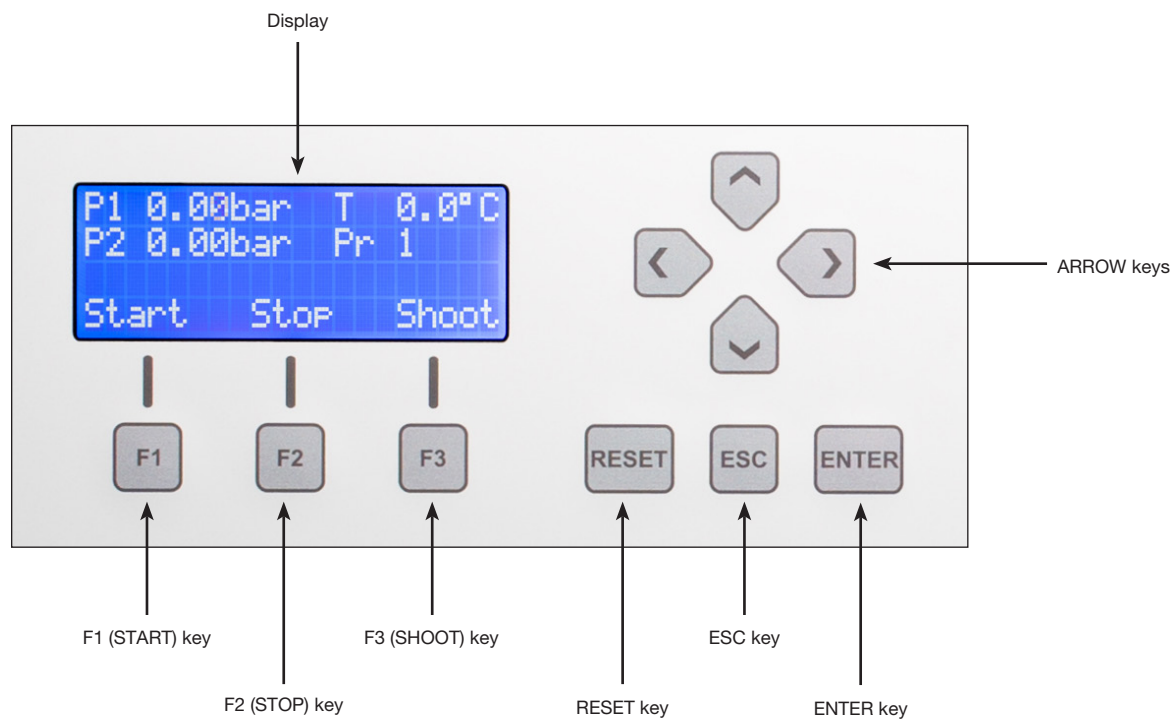

Default Display

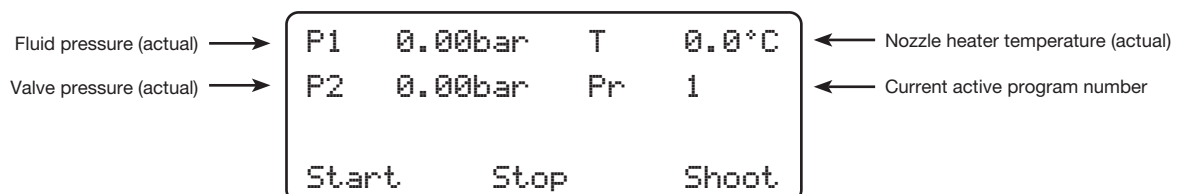

Operation (continued)

Control Panel Keys

Key	Description
F3 (Shoot)	Used for testing or for manual operation: <ul style="list-style-type: none"> • Press F3 to dispense with the current program settings. Refer to "Frequency" on page 25.
F1 (Start) / F2 (Stop)	Used to dispense a series of dots: <ul style="list-style-type: none"> • Press F1 once to dispense at the specified frequency. Refer to "Frequency" on page 25. • Press F2 to stop the dispensing cycle. <p>NOTE: The Start and Stop functions can also be triggered remotely. Refer to "Input Connector Pin Assignments" on page 37 for pin assignments.</p>
ESC	Accesses additional menus or returns a parameter to its previous value: <ul style="list-style-type: none"> • Press ESC once to access additional menus. • Press ESC multiple times to return to the Default display (Actual Value) screen. • Press ESC after changing a value to cancel and return to the previously entered value.
ARROWS	After ESC is pressed, use the UP and DOWN ARROWS as follows: <ul style="list-style-type: none"> • To scroll through menus • To enter corresponding values in the menus. <p>Use the LEFT and RIGHT ARROWS as follows:</p> <ul style="list-style-type: none"> • After ENTER is pressed, to select one of the four programs. • When entering values, to move the cursor a decimal place to the left or right, • To set or release the key lock, simultaneously press both the LEFT and RIGHT ARROWS for about 1.5 seconds.
RESET	Resets the actual value of the Setpoint Counter to zero.
ENTER	<ul style="list-style-type: none"> • Selects or confirms entered values. • Selects a program in the Actual Value screen. Refer to "Selecting a Program" on page 22.

Operation (continued)

Navigating the Controller Menus

Follow this general procedure to view or change any parameter or system setting. Refer to the following sections for detailed information on the controller menus and for parameter or system setting procedures:

- "Flowchart of Menu Structure" on page 20
 - "Viewing or Changing Parameters" on page 23
 - "Viewing or Changing System Settings" on page 28
1. Press ESC to access the main menu.
 2. Press the UP and DOWN ARROWS to move between menus. Press ENTER to select the desired menu.
 3. Press ENTER once more.
The value to be set flashes.
 4. Press the UP or DOWN ARROW to change the value. Use the LEFT or RIGHT ARROW to move the cursor a decimal place to the left or right. When the desired value appears, press ENTER to accept it.
 5. Press ESC two (2) times to return to the main menu / default display.

NOTES:

- A value is entered only after ENTER is pressed. As long as the cursor is blinking, the current value is still in effect.
- Settings stay saved upon power down.

Parameters and System Settings

The Liquidyn V200 controller provides the following programmable parameters and system settings.

NOTES:

- Parameters are saved in a program number. Up to four programs can be saved.
- System settings are applied at the device level, and thus apply to all programs.
- The Digital Input system setting allows you to specify the input type for each program.

Parameter	Range of Values	Description	Procedure
Program Number	1–4	Selects a program number.	Refer to "Selecting a Program" on page 22.
Pulse Time	2–9,999 ms	Sets the electrical actuation time of the valve.	Refer to "Pulse Time" on page 23.
Frequency	0.1–280.0 Hz	Sets the dispensing frequency, or deposits per second.	Refer to "Frequency" on page 25.
Setpoint Counter	0–9,999,999	Sets the number of deposits to be dispensed for the value entered for Frequency.	Refer to "Setpoint Counter" on page 26.
Heater	0–90° C (32–194° F)	Controls the temperature of the optional nozzle heater.	Refer to "Heater" on page 27.
<i>Continued on next page</i>			

Operation (continued)

Parameters and System Settings (continued)

System Setting	Range of Values	Description	Procedure
Language	<ul style="list-style-type: none"> English German 	Sets the language.	Refer to "Language" on page 28.
Heater Cable Length	<ul style="list-style-type: none"> 3 m 5 m 10 m 	Sets the heater cable length.	Refer to "Heater Cable Length" on page 29.
IN-STOP Behavior	<ul style="list-style-type: none"> Normal stop Emergency stop 	<p>Sets how the controller responds to a stop input signal (input 4):</p> <ul style="list-style-type: none"> Normal stop: Dispensing stops when 24 VDC is applied to the stop input. Emergency stop: Requires 24 VDC for normal operation; dispensing stops when 0 VDC is applied to the stop input. This setting is used for safety purposes in the event of heater cable damage. 	Refer to "IN-STOP Behavior" on page 30.
Shoot Release	<ul style="list-style-type: none"> Finish Impulse Stop Immediately 	<p>Sets how the controller responds when an input signal stops:</p> <ul style="list-style-type: none"> Finish Impulse: If Digital Input is set to Shoot and the signal ends, dispensing continues until the complete pattern is dispensed. Stop Immediately: If Digital Input is set to Shoot and the signal ends, dispensing stops immediately without completing the pattern (possibly in the middle of a pulse or dot). 	Refer to "Shoot Release" on page 31.
Digital Input	<ul style="list-style-type: none"> Inactive Single Shoot Infinity 	<p>Sets the input type for each program: In1 sets the input type for program 1, In2 sets the input type for program 2, etc.</p> <ul style="list-style-type: none"> Inactive: The input is deactivated. Single: A single high pulse (24 VDC) on the input starts the dispensing process; dispensing continues until the Setpoint Counter value is reached. Shoot: The dispensing process starts and continues until the signal is 0 VDC. Infinity: The dispensing process starts and continues until 24 VDC is applied to the stop input; if IN-STOP Behavior is set to Emergency Stop, the controller changes this setting to Inactive. 	Refer to "Digital Input" on page 32.

Operation (continued)

Flowchart of Menu Structure

Refer to "Viewing or Changing Parameters" on page 23 for programming procedures.

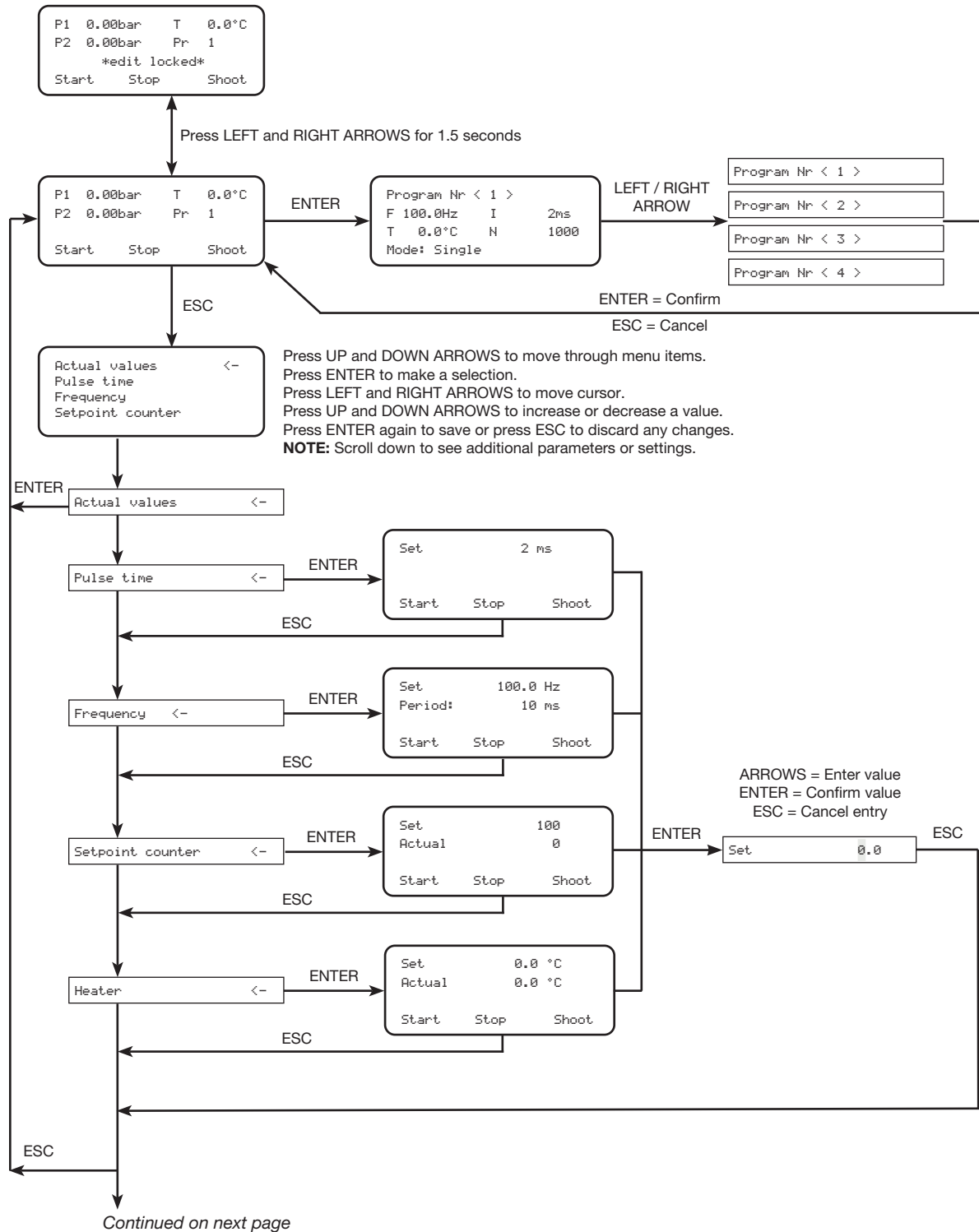

Operation (continued)

Flowchart of Menu Structure (continued)

Refer to "Viewing or Changing System Settings" on page 28 for programming procedures.



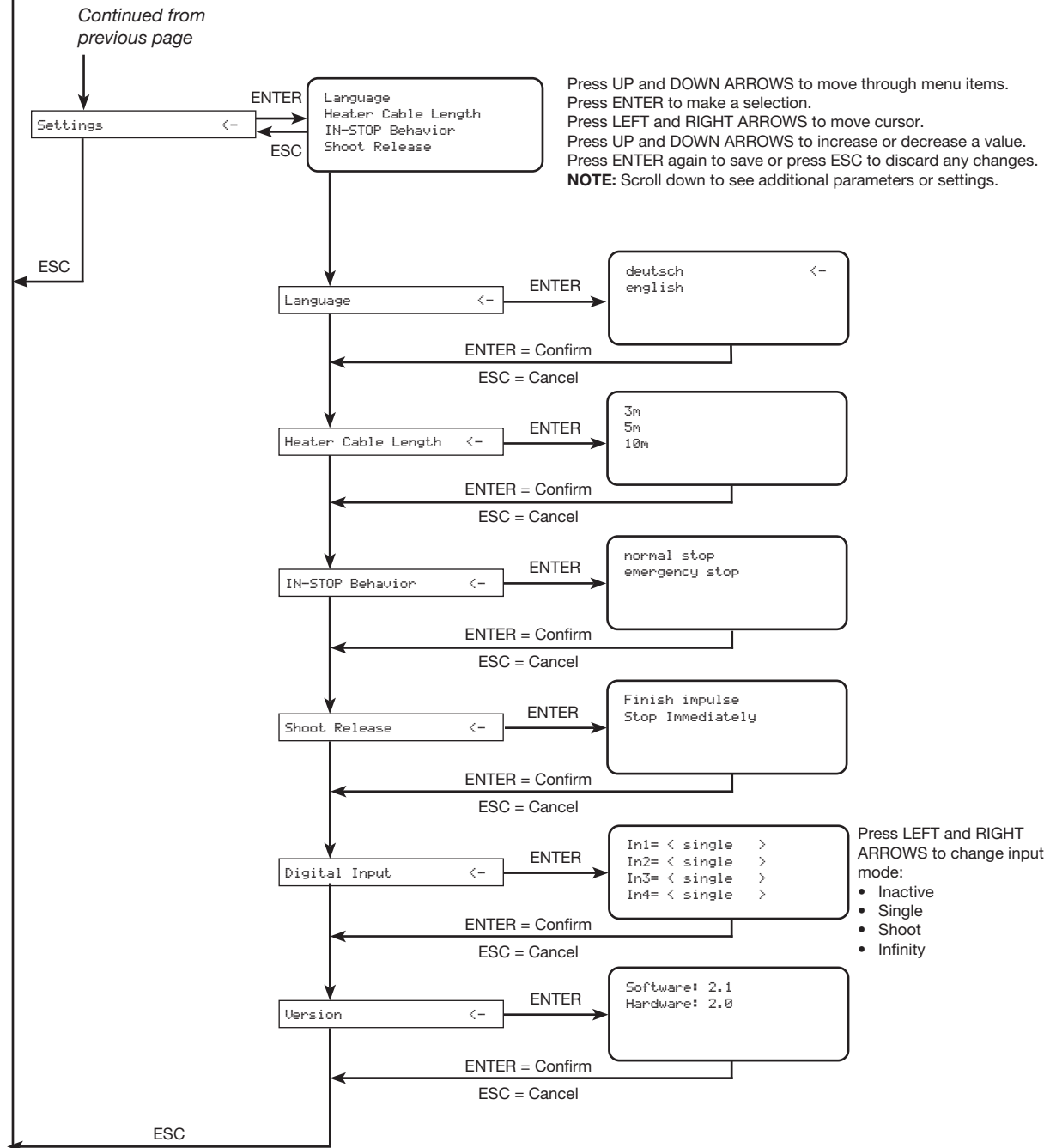



To previous page

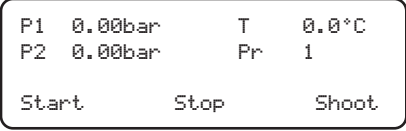

Operation (continued)

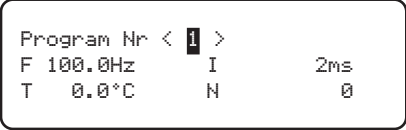
Selecting a Program

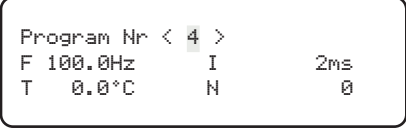
Before viewing or changing any parameters, ensure that the correct program number is selected. All parameter changes are applied to the currently selected program. Follow this procedure to open a program.

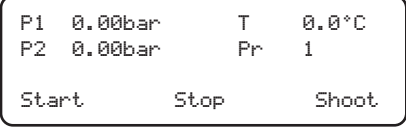
Action / Comment	Display Reference Image
The display shows the Actual Value screen.	 <pre> P1 0.00bar T 0.0°C P2 0.00bar Pr 1 Start Stop Shoot </pre>
Press ENTER one time to select the value (in this example, the 1 with a black background).	  <pre> Program Nr < 1 > F 100.0Hz I 2ms T 0.0°C N 0 </pre>
Press the LEFT or RIGHT ARROW to scroll to the desired program.	
<ul style="list-style-type: none"> The controller can store up to four programs, numbered 1 to 4. 	 <pre> Program Nr < 4 > F 100.0Hz I 2ms T 0.0°C N 0 </pre>
Press ENTER to save the value or press ESC to cancel.	
The display returns to the Actual Value screen.	 <pre> P1 0.00bar T 0.0°C P2 0.00bar Pr 1 Start Stop Shoot </pre>

Operation (continued)

Viewing or Changing Parameters

These parameter-specific procedures are provided for quick-reference. The range of possible values for a parameter is provided within the procedure where applicable.

NOTE: Before making any parameter changes, ensure that the correct program number is selected. All parameter changes are applied to the currently selected program. Refer to "Selecting a Program" on page 22 to switch programs.

Pulse Time

Pulse Time is the electrical actuation time of the valve. The Pulse Time setting varies depending on the valve type.

Liquidyn P-Dot Valve

For Liquidyn P-Dot valves, the Pulse Time must be set to 2 ms. This setting must not be adjusted.

NOTE: A Pulse Time setting other than 2 ms will not alter the amount dispensed, but will affect the dispensing result.

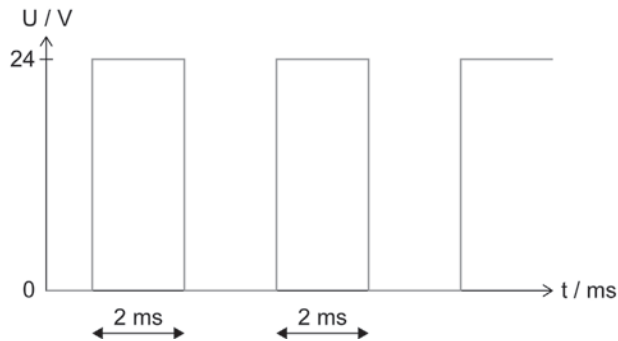

Oscilloscope (valve output) for a Liquidyn P-Dot valve

Liquidyn P-Jet Valve

The Pulse Time setting for Liquidyn P-Jet valves is equivalent to the open time of the valve. The amount dispensed can be directly affected by adjusting the open time.

For Liquidyn P-Jet valves, the Pulse Time can be set from 2 ms to 9,999 ms.



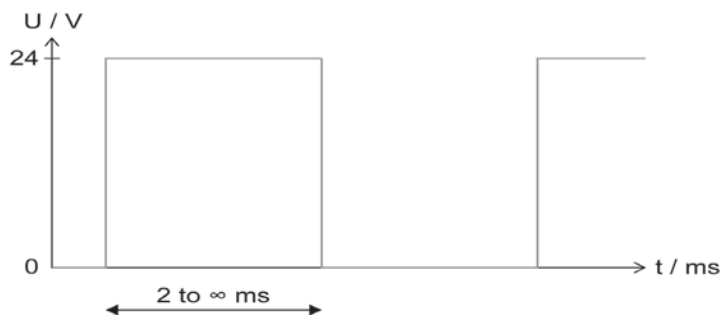





NOTE: The valve will not function properly if the Pulse Time setting is less than 2 ms.

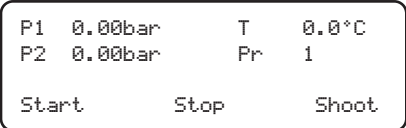

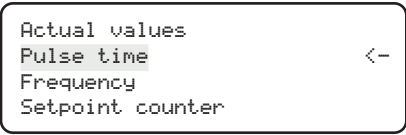
Oscilloscope (valve output) for a Liquidyn P-Jet valve

Operation (continued)







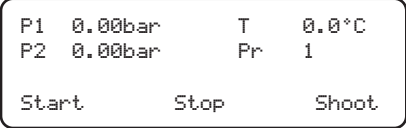

Pulse Time (continued)

Action / Comment	Display Reference Image
The display shows the Actual Value screen.	 <pre> P1 0.00bar T 0.0°C P2 0.00bar Pr 1 Start Stop Shoot </pre>
Press ESC.	
Press the DOWN ARROW to scroll to PULSE TIME (same as Pulse Time).	 4X
	 <pre> Actual values Pulse time <- Frequency Setpoint counter </pre>
Press ENTER two times to select the value (in this example, the 2 with a black background).	 2X
<ul style="list-style-type: none"> For Liquidyn P-Dot valves, the Pulse Time must be set to 2 ms. This setting must not be adjusted. For Liquidyn P-Jet valves, the Pulse Time can be set from 2 to 9999 ms. 	 <pre> Set 2 ms Start Stop Shoot </pre>
Press the UP or DOWN ARROW to scroll to the desired value.	 OR 
Press ENTER to save the value.	
Press ESC two (2) times to return to the default display.	 2X

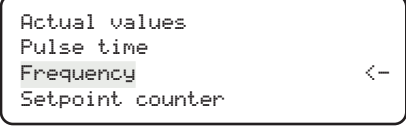
Operation (continued)

Frequency

Use Frequency to set the dispensing frequency, or deposits per second.

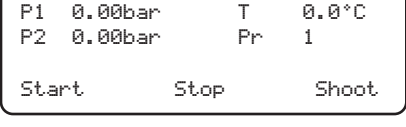
Action / Comment	Display Reference Image
The display shows the Actual Value screen.	
Press ESC.	
Press the DOWN ARROW to scroll to FREQUENCY.	
	
Press ENTER two times to select the value (in this example, the 0 with a black background).	
<ul style="list-style-type: none"> The frequency (shots per second) can be set between 0.1 and 280 Hz. 	
Press the UP or DOWN ARROW to scroll to the desired value.	
	
	<p>OR</p>
Press ENTER to save the value.	
Press ESC two times to return to the default display.	
	<p>2X</p>
The display returns to the Actual Value screen.	

Operation (continued)

Setpoint Counter

Use Setpoint Counter to set the number of deposits to be dispensed for the value entered for Frequency (refer to "Frequency" on page 25).

Under Setpoint Counter:







- SET is user-adjustable and sets how many deposits are to be dispensed.
- ACT shows the actual number of deposits that have been dispensed.

After the desired values are entered for Frequency and Setpoint Counter, press START to initiate the sequence. The valve dispenses the set amount of deposits. After the deposits are dispensed, ACT automatically resets to 0.

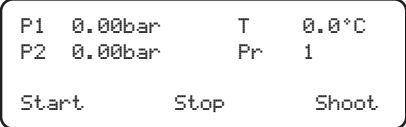
This process can be stopped at any time by pressing STOP, after which you can:

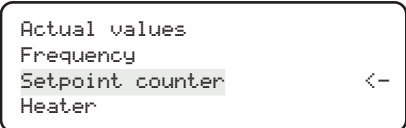
- Restart the process from exactly the same point by pressing START, or
- Set the counter back to 0 by pressing RESET.

NOTE: Setpoint Counter is always active if a value other than 0 is entered for SET. If your application requires continuous operation without an automatic shutoff, enter 0 for SET. If ACT is higher than SET due to external control of the Liquidyn V200 controller, press RESET to enable the control panel again.

Action / Comment	Display Reference Image
The display shows the Actual Value screen.	
Press ESC.	
Press the DOWN ARROW to scroll to SETPOINT COUNTER.	
Press ENTER two times to select the value (in this example, the 0 with a black background).	
<ul style="list-style-type: none"> • The setpoint counter can be set from 0 to 9,999,999. 	
Press the UP or DOWN ARROW to scroll to the desired value.	
Press ENTER to save the value.	
Press ESC two (2) times to return to the default display.	

Operation (continued)

Heater

The Heater parameter controls the temperature of the optional nozzle heater that can be installed on the valve. Refer to the valve manual for information on the optional nozzle heater.

NOTES:







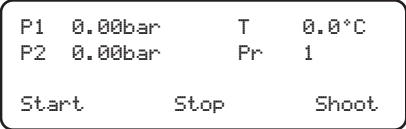

- To obtain most accurate nozzle heater temperature, you must specify the length of the nozzle heater cable under the Settings menu. Refer to "Heater Cable Length" on page 29 to enter the nozzle heater cable length.
- If the controller displays an actual temperature of 0.0° C, then the heater cable is not connected.

WARNING

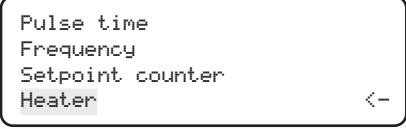
The nozzle heater becomes extremely hot. Wear protective gloves when handling the heater. Before service, switch off the heater control and wait for the heater to cool.

CAUTION

The nozzle heater must be connected to the controller before the controller is switched on. Do not connect a nozzle heater cable if the controller is already switched on. Doing so can damage the heater and the controller.

Action / Comment	Display Reference Image
The display shows the Actual Value screen.	 <pre> P1 0.00bar T 0.0°C P2 0.00bar Pr 1 Start Stop Shoot </pre>
Press ESC.	
Press the DOWN ARROW to scroll to HEATER.	 3X
Press ENTER two times to select the value (in this example, the 0 with a black background).	 <pre> Pulse time Frequency Setpoint counter Heater <- </pre>
<ul style="list-style-type: none"> The temperature can be set from 0–90° C. 	 2X
Press the UP or DOWN ARROW to scroll to the desired value.	 OR 
Press ENTER to save the value.	
Press ESC two (2) times to return to the default display.	 2X









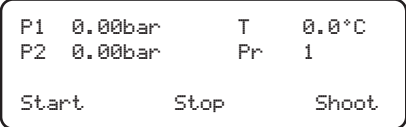

Operation (continued)

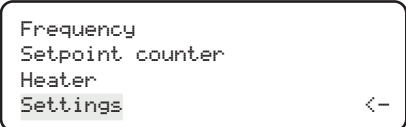
Viewing or Changing System Settings

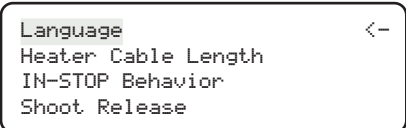
Use these procedures to view or change system settings. Refer to "Parameters and System Settings" on page 18 for a description of all settings and the range of possible values.

Language









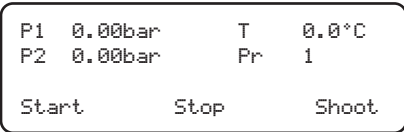

The controller menu is available in two languages: English and German. Follow this procedure to change the language.

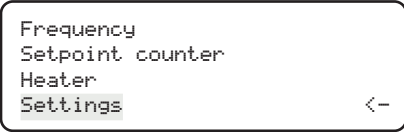
Action / Comment	Display Reference Image
The display shows the Actual Value screen.	
Press ESC.	
Press the DOWN ARROW to scroll to SETTINGS.	
	
Press ENTER.	
Press the DOWN or UP ARROW to scroll to LANGUAGE.	
Press ENTER.	
Press the UP or DOWN ARROW to scroll to the desired value.	
<ul style="list-style-type: none"> The Language can be set to English or German. 	
Press ENTER to save the value.	
Press ESC two (2) times to return to the default display.	

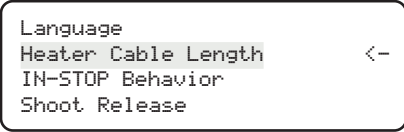
Operation (continued)

Heater Cable Length







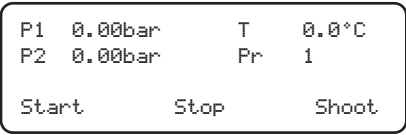

To obtain most accurate nozzle heater temperature, follow this procedure to enter the length of the nozzle heater cable.

Action / Comment	Display Reference Image
The display shows the Actual Value screen.	
Press ESC.	
Press the DOWN ARROW to scroll to SETTINGS.	
Press ENTER.	
Press the DOWN or UP ARROW to scroll to HEATER CABLE LENGTH.	
Press the DOWN or UP ARROW to scroll to HEATER CABLE LENGTH.	
Press ENTER.	
Press the UP or DOWN ARROW to scroll to the desired value.	
<ul style="list-style-type: none"> The heater cable length can be set to 3 m, 5 m, or 10 m. 	
Press ENTER to save the value.	
Press ESC two (2) times to return to the default display.	

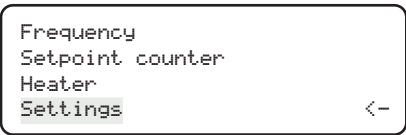
Operation (continued)

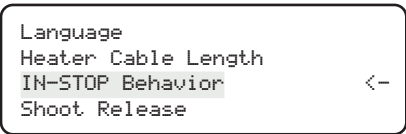
IN-STOP Behavior

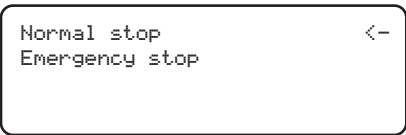





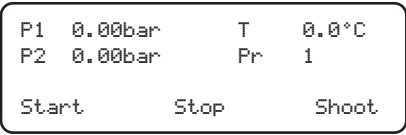

The controller can be set to respond to a stop input signal in two ways: normal or emergency. Refer to "Parameters and System Settings" on page 18 for a detailed description of this system setting. Refer to "Input Connector Pin Assignments" on page 37 for the stop input pin assignments.

Action / Comment	Display Reference Image
The display shows the Actual Value screen.	
Press ESC.	
Press the DOWN ARROW to scroll to SETTINGS.	
	
Press ENTER.	
Press the DOWN or UP ARROW to scroll to IN-STOP BEHAVIOR.	
Press ENTER.	
Press the UP or DOWN ARROW to scroll to the desired value.	
<ul style="list-style-type: none"> IN-STOP Behavior can be set to Normal Stop or Emergency Stop. Refer to "Parameters and System Settings" on page 18 for a detailed description of this system setting. 	
Press ENTER to save the value.	
Press ESC two (2) times to return to the default display.	

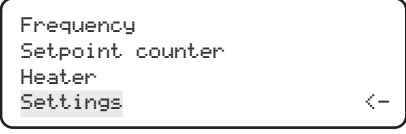
Operation (continued)

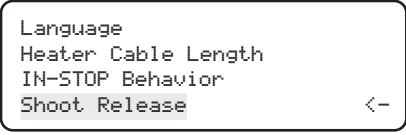
Shoot Release

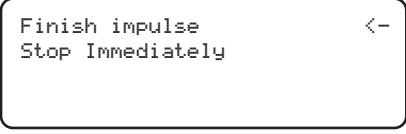





When the Digital Input setting for a program is set to Shoot, use Shoot Release to specify how the controller responds when an input signal stops. Refer to "Parameters and System Settings" on page 18 for a detailed description of this system setting.

Action / Comment	Display Reference Image
The display shows the Actual Value screen.	
Press ESC.	
Press the DOWN ARROW to scroll to SETTINGS.	
	
Press ENTER.	
Press the DOWN or UP ARROW to scroll to SHOOT RELEASE.	
Press ENTER.	
Press the UP or DOWN ARROW to scroll to the desired value.	
<ul style="list-style-type: none"> Shoot Release can be set to Finish Impulse or Stop Immediately. Refer to "Parameters and System Settings" on page 18 for a detailed description of this system setting. 	
Press ENTER to save the value.	
Press ESC two (2) times to return to the default display.	

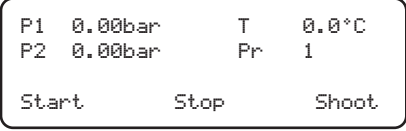
Operation (continued)

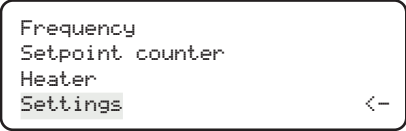
Digital Input

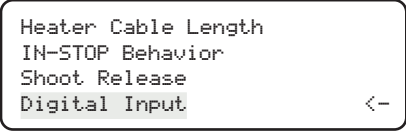

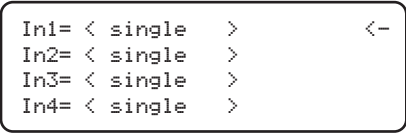

The type of digital input for each program (1 to 4) can be set to one of four selections. Refer to "Parameters and System Settings" on page 18 for a detailed description of this system setting.

Action / Comment	Display Reference Image
The display shows the Actual Value screen.	 <pre> P1 0.00bar T 0.0°C P2 0.00bar Pr 1 Start Stop Shoot </pre>
Press ESC.	
Press the DOWN ARROW to scroll to SETTINGS.	
	 <pre> Frequency Setpoint counter Heater Settings <- </pre>
Press ENTER.	
Press the DOWN or UP ARROW to scroll to DIGITAL INPUT.	 <pre> Heater Cable Length IN-STOP Behavior Shoot Release Digital Input <- </pre>
Press ENTER.	
Press the UP or DOWN ARROW to scroll to the desired value.	
<p>NOTE:</p> <p>In1 sets the Digital Input type for program 1. In2 sets the Digital Input type for program 2. In3 sets the Digital Input type for program 3. In4 sets the Digital Input type for program 4.</p>	 <pre> In1= < single > <- In2= < single > In3= < single > In4= < single > </pre>

Continued on next page

Operation (continued)

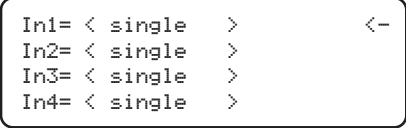





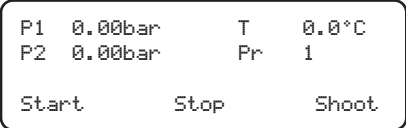

Digital Input (continued)

Action / Comment	Display Reference Image
Press ENTER.	
Press the LEFT or RIGHT ARROW to select the desired input mode.	 OR 
<ul style="list-style-type: none"> Each digital Input can be set to Inactive, Single, Shoot, or Infinity. Refer to "Parameters and System Settings" on page 18 for a detailed description of this system setting. 	
Press ENTER to save the value.	
Press ESC two (2) times to return to the default display.	 2X

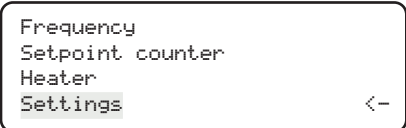
Operation (continued)

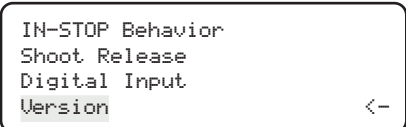
Viewing the Software and Hardware Versions

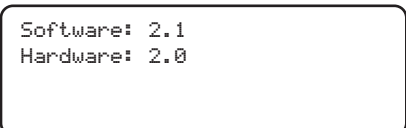
Follow this procedure to determine the current versions of the V200 software and hardware.

Action / Comment	Display Reference Image
The display shows the Actual Value screen.	 <pre> P1 0.00bar T 0.0°C P2 0.00bar Pr 1 Start Stop Shoot </pre>
Press ESC.	
Press the DOWN ARROW to scroll to SETTINGS.	
	 <pre> Frequency Setpoint counter Heater Settings <- </pre>
Press ENTER.	
Press the DOWN ARROW to scroll to VERSION. NOTE: Version is the very last item on the settings menu.	 <pre> IN-STOP Behavior Shoot Release Digital Input Version <- </pre>
Press ENTER.	
<ul style="list-style-type: none"> The display shows the current software and hardware versions. 	 <pre> Software: 2.1 Hardware: 2.0 </pre>
Press ESC two (2) times to return to the default display.	

Part Number

Part #	Description
7825168	Liquidyn V200 controller

Replacement Parts

Part #	Description	Item
7825173	Power cord and power supply (AC/DC external power adapter)	

Troubleshooting

These troubleshooting tables cover the most commonly encountered issues. If the tables do not help you correct an issue, contact Nordson EFD.

Air Pressure Problems

Problem	Possible Cause	Corrective Action
Dispensing results not reproducible	Input air pressure to controller too low	Ensure that the input pressure is 1 bar higher than the required operating pressure.
	Input air pressure to controller has large fluctuations	Ensure that the input pressure is constant. Use a pneumatic accumulator if necessary.
Unable to set the pressure	Pressure adjustment knobs cannot be turned	Unlock the pressure adjustment knobs by pulling out the knobs.
Valve not dispensing	P1 fluid pressure and P2 valve (operating) pressure connections switched	Ensure that the fluid (P1) and valve (P2) pressure connections are correct. Refer to "Make the System Connections" on page 14.

Electrical Problems

Problem	Possible Cause	Corrective Action
Heater not working	Current limit for the power supply (via external power cable) set too low	Ensure that the current limit does not impede the current.
	Cable not connected	Ensure that the heater cable is properly connected and secure.
Controller not responding to remote input	Incorrect input signal	Ensure that input signals are as follows: 0 VDC (logical low) 24 VDC (logical high)
Despite constant pressure, displayed pressure values continue to vary	Residual ripple in the electric supply	Ensure that the supply voltage conforms to the required 24 VDC.
Intermittent or interrupted signal	Signal bounce (transient signals not representing true switch setting)	Check the input signal terminations and ensure that a single signal exists to trigger the controller. Use the solid state relays / switches of the PLC output modules for the input signals to the V200 Controller. Avoid using mechanical contacts.

Technical Data

Input Connector Pin Assignments

Refer to "Input / Output Circuit Wiring Diagrams" on page 38 for additional information.

Pin	Direction	Assignment	Description
1	Output	+ 24 VDC, max. 200 mA	24V auxiliary voltage
2		Not assigned	
3	Input	+ Start 1	Starts program 1
4	Input	+ Stop	Stops selected program
5	Input	+ Shoot	Deposits as long as a signal is recognized
6	Input	+ Reset	Resets all Setpoint Counter values to zero (0)
7	Input	+ Start 2	Starts program 2
8	Input	+ Start 3	Starts program 3
9	Input	+ Start 4	Starts program 4
10	Output	+ Busy	Logical high: Controller is dispensing
11	Output	+ Temperature monitoring	Logical high: Temperature is not reached
12	Output	+ Counter	8 ms logical high impulse signal every shot
13	Output	GND	Ground
14		Not assigned	
15	Input	- Start 1	
16	Input	- Stop	
17	Input	- Shoot	
18	Input	- Reset	
19	Input	- Start 2	
20	Input	- Start 3	
21	Input	- Start 4	
22	Output	- Busy	
23	Output	- Temperature monitoring	
24	Output	- Counter	
25		Not assigned	

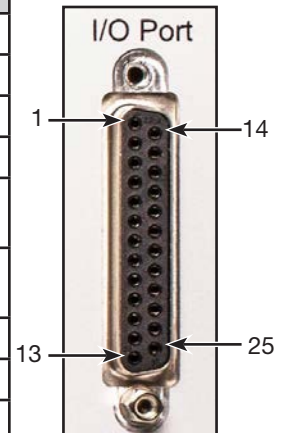

Technical Data (continued)

Input / Output Circuit Wiring Diagrams

Inputs

- Input circuits require approximately 0.006 Amps
- Input pulse length should be at least 2 ms
- Signals will not be debounced.
- Avoid using mechanical contacts for the input signals being sent to the V200 Controller. Use solid state relays to prevent signal bounce issues.

Input	Description
START 1	Starts and runs the application using the program 1 parameters until the value entered for Setpoint Counter is reached. Program 1 is shown on the display. NOTE: A program can only be started after another program stops.
START 2	Same as START 1 but applies to program 2.
START 3	Same as START 1 but applies to program 3.
START 4	Same as START 1 but applies to program 4.
STOP	Stops the application.
SHOOT	The application runs as long as the input recognizes a logical high signal.
RESET	Resets the Setpoint Counter value of all programs to zero (0).

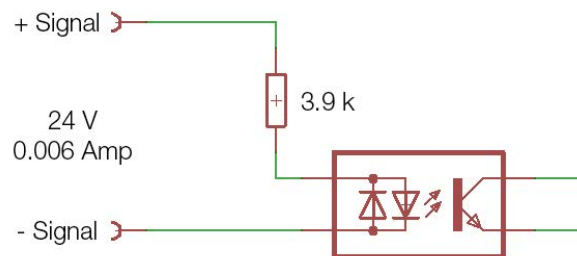

Outputs

- Output circuits provide a maximum of 0.050 Amps.
- Circuits are switched outputs, with high resistance if they have a logical low and low resistance if they have a logical high.

Output	Description
COUNTER	Provides a pulse signal with a length of approximately 8 ms for every deposit cycle.
BUSY	Logical high if the application is running; logical low if the application is not running.
TEMPERATURE MONITORING	Logical high if the value entered for heater temperature is not reached [approximately 3° C (38° F) differential].

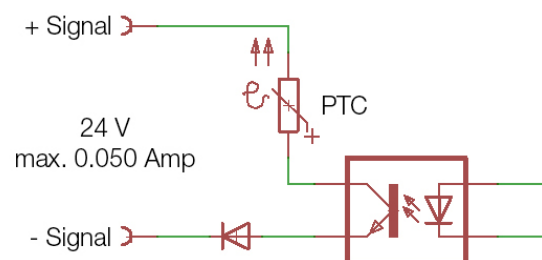

Technical Data (continued)

Wiring Diagrams for Connecting the V200 to a PLC

High Level Signal

- V200 Start inputs (1–4) triggered with a high level signal
- V200 Stop input defined as an Emergency Stop
- Potential separation

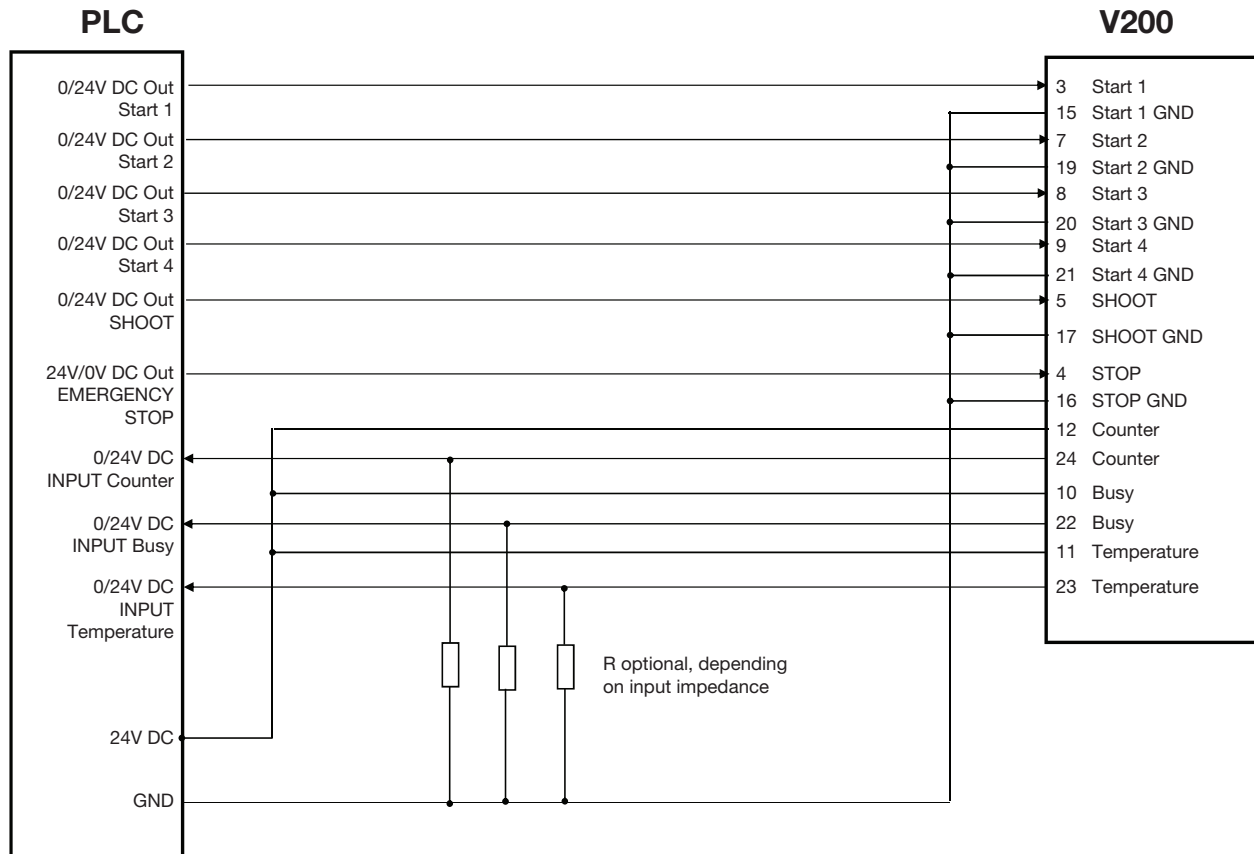

Technical Data (continued)

Wiring Diagrams for Connecting the V200 to a PLC (continued)

Low Level Signal

- V200 Start inputs (1–4) triggered with low level signal
- V200 Stop input defined as a normal stop
- Potential separation

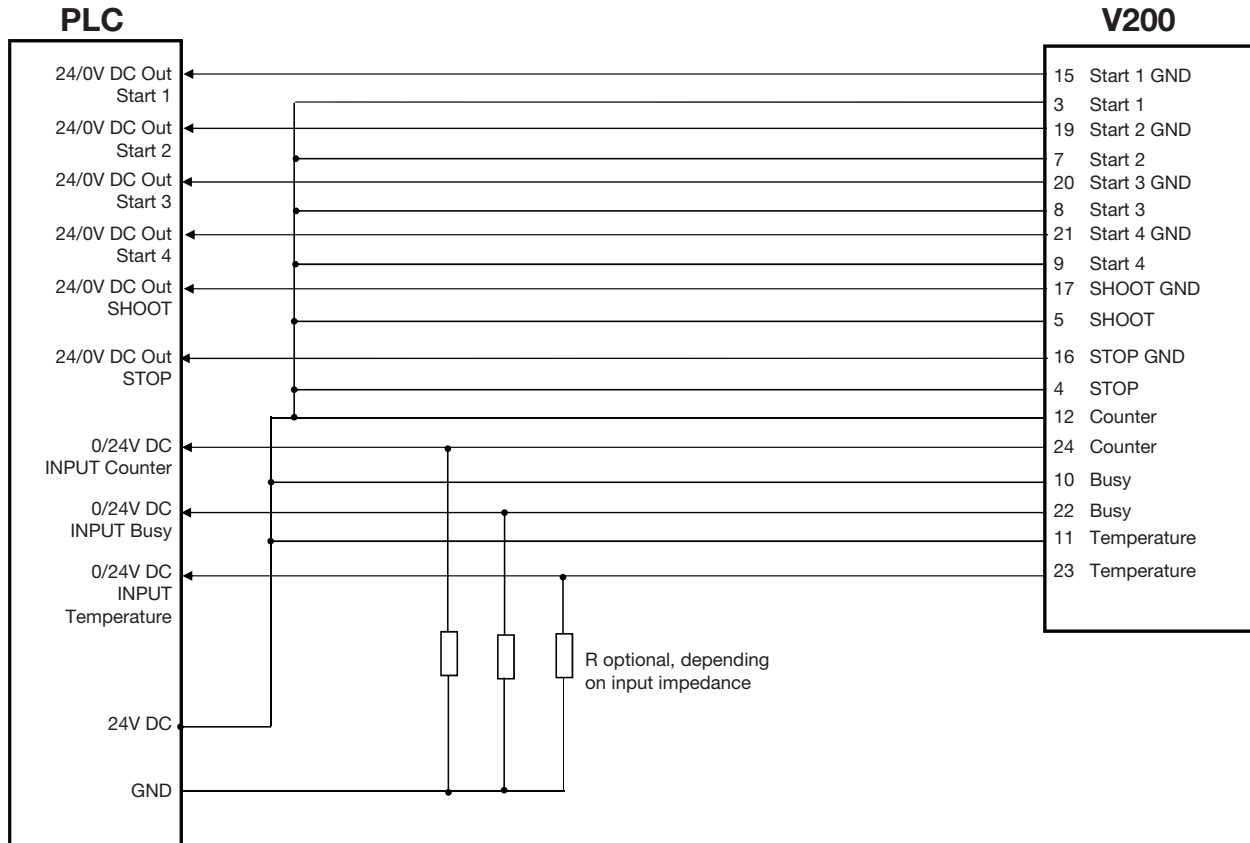

NORDSON EFD ONE YEAR LIMITED WARRANTY

This Nordson EFD product is warranted for one year from the date of purchase to be free from defects in material and workmanship (but not against damage caused by misuse, abrasion, corrosion, negligence, accident, faulty installation, or by dispensing material incompatible with equipment) when the equipment is installed and operated in accordance with factory recommendations and instructions.

Nordson EFD will repair or replace free of charge any defective part upon authorized return of the part prepaid to our factory during the warranty period. The only exceptions are those parts which normally wear and must be replaced routinely, such as, but not limited to, valve diaphragms, seals, valve heads, needles, and nozzles.

In no event shall any liability or obligation of Nordson EFD arising from this warranty exceed the purchase price of the equipment.

Before operation, the user shall determine the suitability of this product for its intended use, and the user assumes all risk and liability whatsoever in connection therewith. Nordson EFD makes no warranty of merchantability or fitness for a particular purpose. In no event shall Nordson EFD be liable for incidental or consequential damages.

This warranty is valid only when oil-free, clean, dry, filtered air is used, where applicable.



For Nordson EFD sales and service in over 40 countries, contact Nordson EFD or go to www.nordsonefd.com.

Global

800-556-3484; +1-401-431-7000
info@nordsonefd.com

Europe

00800 7001 7001
infoefd.europe@nordsonefd.com

Asia

China: +86 (21) 3866 9006; china@nordsonefd.com
India: +91 80 4021 3600; india@nordsonefd.com
Japan: +81 03 5762 2760; japan@nordsonefd.com
Korea: +82-31-736-8321; korea@nordsonefd.com
SEAsia: +65 6796 9522; sin-mal@nordsonefd.com

The Wave Design is a trademark of Nordson Corporation.
©2020 Nordson Corporation 7362052 v100520