

ValveMate 9000 Controller

Operating Manual



Electronic pdf files of Nordson EFD manuals are also available at www.nordsonefd.com



You have selected a reliable, high-quality dispensing system from Nordson EFD, the world leader in fluid dispensing. The ValveMate™ 9000 Controller was designed specifically for industrial dispensing and will provide you with years of trouble-free, productive service.

This manual will help you maximize the usefulness of your ValveMate 9000 Controller.

Please spend a few minutes to become familiar with the controls and features. Follow our recommended testing procedures. Review the helpful information we have included, which is based on more than 50 years of industrial dispensing experience.

Most questions you will have are answered in this manual. However, if you need assistance, please do not hesitate to contact EFD or your authorized EFD distributor. Detailed contact information is provided on the last page of this document.

The Nordson EFD Pledge

Thank You!

You have just purchased the world's finest precision dispensing equipment.

I want you to know that all of us at Nordson EFD value your business and will do everything in our power to make you a satisfied customer.

If at any time you are not fully satisfied with our equipment or the support provided by your Nordson EFD Product Application Specialist, please contact me personally at 800.556.3484 (US), 401.431.7000 (outside US), or Srini.Subramanian@nordsonefd.com.

I guarantee that we will resolve any problems to your satisfaction.

Thanks again for choosing Nordson EFD.

Srini Subramanian

Srini Subramanian, General Manager



Contents

- Contents 3
- Introduction 5
- Nordson EFD Product Safety Statement 6
 - Halogenated Hydrocarbon Solvent Hazards 7
 - High Pressure Fluids 7
 - Qualified Personnel 7
 - Intended Use 8
 - Regulations and Approvals 8
 - Personal Safety 8
 - Fire Safety 9
 - Preventive Maintenance 9
 - Important Disposable Component Safety Information 10
 - Action in the Event of a Malfunction 10
 - Disposal 10
 - Equipment-Specific Safety Information 11
 - Safety Ground Connection 11
 - AC Power Connection 11
 - Equipment-Specific Safety Labels and Tags 11
- Specifications 12
- Operating Features 14
 - Front Panel Components 14
 - Back Panel Components 15
 - Back Panel Markings 16
- Installation 17
 - Key Components of a Typical Fluid Reservoir Installation 17
 - Unpack the Controller Components 18
 - Install the Ancillary System Components 19
 - Mount the Controller 19
 - Connect Power 20
 - Connect Air 21
 - AIR OUT Connections 21
 - AIR IN Connection 22
 - EXHAUST Connection 22
 - Connect Wiring 23
 - Connect a Dispense Valve Initiate Signal 23
 - Connect Driver Outputs 23
 - Connect Heater Outputs and Temperature Control Feedback 24
 - Connect General Purpose Inputs / Outputs 25
 - Check the Component Installation 26

Continued on next page



Contents (continued)

Setup	27
About the MAIN Screen	27
Navigating through the Controller Screens.....	28
Connecting the Controller to a Computer	30
Enabling / Disabling the Controller	31
Setting Units of Pressure	32
Setting Units of Temperature	32
Entering Driver Spike-and-Hold Settings	33
Setting Up the Driver Outputs	34
Setting Up Pressure Control	36
Setting Up Heater Control	37
Setting Up the General Purpose I/Os	38
Entering Memory Cell Settings	40
Setting Up the Auto Increment Mode	41
Entering the Auto Increment Mode Alarm Setting	44
Entering Pressure Alarm Settings	45
Entering Heater Alarm Settings	46
Setting Alarm Options.....	47
Setting the RS-232C Baud Rate.....	49
Adjusting the LCD Contrast.....	50
Viewing the Controller Part Number and Firmware Revision Level	50
System Startup and Operation.....	51
Clearing Alarms	52
Clearing a Pressure or Heater Alarm	52
Clearing an Alarm Input or Auto Increment Mode Alarm.....	53
Clearing a Heater Fault Alarm.....	54
Clearing a Thermocouple (TC) Fault Alarm.....	55
Part Number	56
Replacement Parts	56
Troubleshooting.....	57
Appendix A, Connector Pin Technical Data	61
Heater Outputs	61
Driver Outputs.....	62
Foot Pedal Connector.....	63
Foot Pedal Connector Schematic.....	63
I/O Connector	64
I/O Connector Schematics	66
Appendix B, RS-232C Connection Technical Information	68
RS-232C Pins	68
RS-232C Protocol.....	68
RS-232C Commands	69
Main Menu and Main Screen	70
Temperature Menu	71
Pressure Menu	72
Driver Menu	73
General Purpose I/O and I/O Menus.....	75
Specific Alarms and Auto Increment.....	77
Miscellaneous	78
Appendix C, Driver Spike-and-Hold Technical Data	79
Appendix D, Settings Stored in Memory Cells	81

Introduction

The ValveMate 9000 dispensing valve controller includes a programmable dispensing time setting, digital time readout, keypad programming for easy user interface, and input / output (I/O) communication with host machine PLCs.

Other features include:

- Programmable fluid pressure and temperature settings
- An Auto Increment mode that adjusts dispensing parameters after a certain number of shots or a specific elapsed time
- An Auto Sequence mode that allows deposit patterns to be repeated automatically
- 100 individual memory storage cells
- Remote programming capability via external PC or PLC
- A front panel manual dispense cycle key
- Four independent general-purpose input / output (I/O) drivers
- Alarm indicators
- Adjustable LCD display brightness
- Two end-of-cycle feedback circuits
- Dual variable-voltage (5–24 VDC, 24 W) valve drivers with spike-and-hold capability
- Cycle counter display for each valve driver
- Dual 24 W temperature controllers for J-type thermocouples
- Dual electronic pressure regulators

To obtain maximum performance from this equipment, please read the instructions carefully.



fluid management

Nordson EFD Product Safety Statement

WARNING

The safety message that follows has a WARNING level hazard.
Failure to comply could result in death or serious injury.



ELECTRIC SHOCK

Risk of electric shock. Disconnect power before removing covers and / or disconnect, lock out, and tag switches before servicing electrical equipment. If you receive even a slight electrical shock, shut down all equipment immediately. Do not restart the equipment until the problem has been identified and corrected.

CAUTION

The safety messages that follow have a CAUTION level hazard.
Failure to comply may result in minor or moderate injury.



READ MANUAL

Read manual for proper use of this equipment. Follow all safety instructions. Task- and equipment-specific warnings, cautions, and instructions are included in equipment documentation where appropriate. Make sure these instructions and all other equipment documents are accessible to persons operating or servicing equipment.



MAXIMUM AIR PRESSURE

Unless otherwise noted in the product manual, the maximum air input pressure is 7.0 bar (100 psi). Excessive air input pressure may damage the equipment. Air input pressure is intended to be applied through an external air pressure regulator rated for 0 to 7.0 bar (0 to 100 psi).



RELEASE PRESSURE

Release hydraulic and pneumatic pressure before opening, adjusting, or servicing pressurized systems or components.



BURNS

Hot surfaces! Avoid contact with the hot metal surfaces of heated components. If contact can not be avoided, wear heat-protective gloves and clothing when working around heated equipment. Failure to avoid contact with hot metal surfaces can result in personal injury.

Nordson EFD Product Safety Statement (continued)

Halogenated Hydrocarbon Solvent Hazards

Do not use halogenated hydrocarbon solvents in a pressurized system that contains aluminum components. Under pressure, these solvents can react with aluminum and explode, causing injury, death, or property damage. Halogenated hydrocarbon solvents contain one or more of the following elements.

Element	Symbol	Prefix
Fluorine	F	"Fluoro-"
Chlorine	Cl	"Chloro-"
Bromine	Br	"Bromo-"
Iodine	I	"Iodo-"

Check the Safety Data Sheet (SDS) or contact your material supplier for more information. If you must use halogenated hydrocarbon solvents, contact your EFD representative for compatible EFD components.

High Pressure Fluids

High pressure fluids, unless they are safely contained, are extremely hazardous. Always release fluid pressure before adjusting or servicing high pressure equipment. A jet of high pressure fluid can cut like a knife and cause serious bodily injury, amputation, or death. Fluids penetrating the skin can also cause toxic poisoning.

WARNING

Any injury caused by high pressure liquid can be serious. If you are injured or even suspect an injury:

- Go to an emergency room immediately.
- Tell the doctor that you suspect an injection injury.
- Show the doctor the following note.
- Tell the doctor what kind of material you were dispensing.

Medical Alert — Airless Spray Wounds: Note to Physician

Injection in the skin is a serious traumatic injury. It is important to treat the injury surgically as soon as possible. Do not delay treatment to research toxicity. Toxicity is a concern with some exotic coatings injected directly into the bloodstream.

Qualified Personnel

Equipment owners are responsible for making sure that EFD equipment is installed, operated, and serviced by qualified personnel. Qualified personnel are those employees or contractors who are trained to safely perform their assigned tasks. They are familiar with all relevant safety rules and regulations and are physically capable of performing their assigned tasks.

Nordson EFD Product Safety Statement (continued)

Intended Use

Use of EFD equipment in ways other than those described in the documentation supplied with the equipment may result in injury to persons or damage to property. Some examples of unintended use of equipment include:

- Using incompatible materials.
- Making unauthorized modifications.
- Removing or bypassing safety guards or interlocks.
- Using incompatible or damaged parts.
- Using unapproved auxiliary equipment.
- Operating equipment in excess of maximum ratings.
- Operating equipment in an explosive atmosphere.

Regulations and Approvals

Make sure all equipment is rated and approved for the environment in which it is used. Any approvals obtained for Nordson EFD equipment will be voided if instructions for installation, operation, and service are not followed. If the equipment is used in a manner not specified by Nordson EFD, the protection provided by the equipment may be impaired.

Personal Safety

To prevent injury, follow these instructions:

- Do not operate or service equipment unless you are qualified.
- Do not operate equipment unless safety guards, doors, and covers are intact and automatic interlocks are operating properly. Do not bypass or disarm any safety devices.
- Keep clear of moving equipment. Before adjusting or servicing moving equipment, shut off the power supply and wait until the equipment comes to a complete stop. Lock out power and secure the equipment to prevent unexpected movement.
- Make sure spray areas and other work areas are adequately ventilated.
- When using a syringe barrel, always keep the dispensing end of the tip pointing towards the work and away from the body or face. Store syringe barrels with the tip pointing down when they are not in use.
- Obtain and read the Safety Data Sheet (SDS) for all materials used. Follow the manufacturer's instructions for safe handling and use of materials and use recommended personal protection devices.
- Be aware of less-obvious dangers in the workplace that often cannot be completely eliminated, such as hot surfaces, sharp edges, energized electrical circuits, and moving parts that cannot be enclosed or otherwise guarded for practical reasons.
- Know where emergency stop buttons, shutoff valves, and fire extinguishers are located.
- Wear hearing protection to protect against hearing loss that can be caused by exposure to vacuum exhaust port noise over long periods of time.

Nordson EFD Product Safety Statement (continued)

Fire Safety

To prevent a fire or explosion, follow these instructions:

- Shut down all equipment immediately if you notice static sparking or arcing. Do not restart the equipment until the cause has been identified and corrected.
- Do not smoke, weld, grind, or use open flames where flammable materials are being used or stored.
- Do not heat materials to temperatures above those recommended by the manufacturer. Make sure heat monitoring and limiting devices are working properly.
- Provide adequate ventilation to prevent dangerous concentrations of volatile particles or vapors. Refer to local codes or the SDS for guidance.
- Do not disconnect live electrical circuits when working with flammable materials. Shut off power at a disconnect switch first to prevent sparking.
- Know where emergency stop buttons, shutoff valves, and fire extinguishers are located.

Preventive Maintenance

As part of maintaining continuous trouble-free use of this product, Nordson EFD recommends the following simple preventive maintenance checks:

- Periodically inspect tube-to-fitting connections for proper fit. Secure as necessary.
- Check tubing for cracks and contamination. Replace tubing as necessary.
- Check all wiring connections for looseness. Tighten as necessary.
- Clean: If a front panel requires cleaning, use a clean, soft, damp rag with a mild detergent cleaner. DO NOT USE strong solvents (MEK, acetone, THF, etc.) as they will damage the front panel material.
- Maintain: Use only a clean, dry air supply to the unit. The equipment does not require any other regular maintenance.
- Test: Verify the operation of features and the performance of equipment using the appropriate sections of this manual. Return faulty or defective units to Nordson EFD for replacement.
- Use only replacement parts that are designed for use with the original equipment. Contact your Nordson EFD representative for information and advice.

Nordson EFD Product Safety Statement (continued)

Important Disposable Component Safety Information

All Nordson EFD disposable components, including syringe barrels, cartridges, pistons, tip caps, end caps, and dispense tips, are precision engineered for one-time use. Attempting to clean and re-use components will compromise dispensing accuracy and may increase the risk of personal injury.

Always wear appropriate protective equipment and clothing suitable for your dispensing application and adhere to the following guidelines:

- Do not heat syringe barrels or cartridges to a temperature greater than 38° C (100° F).
- Dispose of components according to local regulations after one-time use.
- Do not clean components with strong solvents (MEK, acetone, THF, etc.).
- Clean cartridge retainer systems and barrel loaders with mild detergents only.
- To prevent fluid waste, use Nordson EFD SmoothFlow™ pistons.

Action in the Event of a Malfunction

If a system or any equipment in a system malfunctions, shut off the system immediately and perform the following steps:

1. Disconnect and lock out system electrical power. If using hydraulic and pneumatic shutoff valves, close and relieve pressure.
2. For Nordson EFD air-powered dispensers, remove the syringe barrel from the adapter assembly. For Nordson EFD electro-mechanical dispensers, slowly unscrew the barrel retainer and remove the barrel from the actuator.
3. Identify the reason for the malfunction and correct it before restarting the system.

Disposal

Dispose of equipment and materials used in operation and servicing according to local codes.

Nordson EFD Product Safety Statement (continued)

Equipment-Specific Safety Information

Safety Ground Connection

Nordson EFD controllers are designed with a three-position IEC 60320-C14 receptacle that connects the ground line to the chassis ground. To minimize shock hazard, make sure your electrical power outlet and power cord have an appropriate earth safety ground that is connected whenever you power up the controller.

If your power outlet does not have an appropriate ground connection, you must connect a safety ground to the chassis grounding screw located on the rear panel of the unit. To connect the safety ground, complete the following steps:

1. Connect a 16 AWG (1.3 mm) wire to the chassis grounding screw on the rear of the chassis using a toothed grounding lug. The wire must have green insulation with a yellow stripe or must be noninsulated (bare).
2. Attach the opposite end of the wire to a permanent earth ground using toothed washers or a toothed lug.

AC Power Connection

CAUTION

- The power supply cord is used as the main disconnect device. Ensure that the power outlet is located near the equipment and is easily accessible.
- Use only the supplied power cord.
- Use only on a circuit with a fuse or circuit breaker that is 20 A or less.

Equipment-Specific Safety Labels and Tags



Burn Warning

Warning symbol informing of the risk of burns from a hot valve. Connect power to heated valves as specified in the valve operating manual.



Maximum Air Pressure Caution

Caution symbol informing that the maximum air input pressure is 6.9 bar (100 psi). Excessive air input pressure may damage the equipment.



Electrical Shock Warning

Warning symbol informing of the risk of electrical shock. Disconnect the power cord before removing the electrical cover.

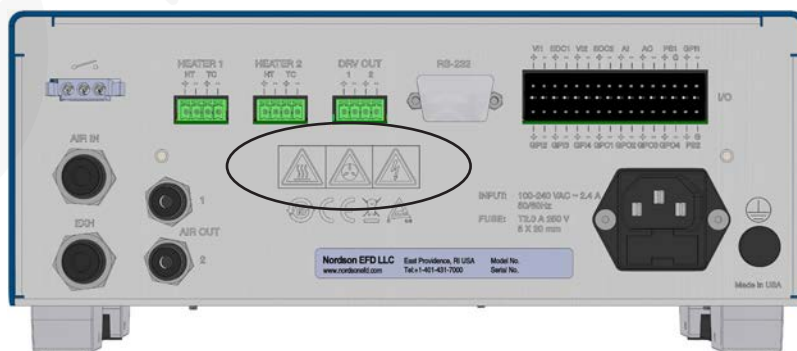

Specifications

Item	Specification
Cabinet size	255.0w x 111.0H x 214.0D mm (10.04w x 4.36H x 8.43D")
Weight	3.5 kg (7.6 lb)
Electrical power input	100–240 VAC ($\pm 10\%$), 2.4 Amp maximum, 50/60Hz
External power adapter	100–240 VAC ($\pm 10\%$), ~50/60Hz input, desktop type, AC input: IEC 320 inlet
Internal voltage	24 VDC
Foot pedal	24 VDC
Input air pressure	4.8–6.9 bar (70–100 psi)
Air output	<p>Setpoint range: 0–100 psi (0–6.9 bar) in 0.1 psi increments</p> <p>Linearity: within $\pm 2\%$ (full span)</p> <p>Hysteresis: within 1% (full span)</p> <p>Repeatability: within $\pm 1\%$ (full span)</p> <p>Sensitivity: within 0.3% (full span)</p> <p>Sample rate: 16 per second</p> <p>Maximum flow rate: 6 l/min (ANR) with supply pressure at 87 psi</p> <p>Number of outputs: 2</p> <p>Setup methods: (1) digital using the front panel keys or (2) remotely using a serial cable (RS-232C)</p> <p>Other functions: Pressure Alarm (non-latching / latching)</p>
Feedback circuits	<p>End of Cycle (EOC) 1–2 and Alarm Out (AO): Electronic switch, 24 VDC, 100 mA maximum</p> <p>Refer to Appendix A, "I/O Connector Pin Technical Data."</p>
Initiate circuits	<p>Voltage Initiate (VI) signals 1–2: 5–24 VDC</p> <p>NOTE: The 5–24 VDC VI signal duration is no less than 200 μs momentary, or maintained for steady mode operation.</p> <p>Foot pedal: Dry contact initiate circuit, 19 mA closure current</p> <p>NOTE: The foot pedal initiate signal is de-bounced for a period of 20 ms. To disable the de-bounce on the foot pedal signal, press the 5 key during power up or use the serial command through a serial cable (RS-232C).</p>
Driver outputs	<p>Setpoint range: 0.0001–9.9999 s, 100 μs resolution</p> <p>Accuracy: within $\pm 0.05\%$ of the selected time setting</p> <p>Repeatability: less than 16 μs at any time setting</p> <p>Number of outputs: 2</p> <p>Outputs: 24 VDC, 24 W maximum per channel</p> <p>Output voltage: 5–24 VDC, 1 volt resolution</p> <p>Cycle rate: up to 500Hz</p> <p>Spike-and-hold, hold voltage: 5–24 VDC, 1 volt resolution</p> <p>Spike time: 20–250 ms, 5 ms resolution</p> <p>Setup method: (1) digital using the front panel keys or (2) remotely using a serial cable (RS-232C)</p>

Continued on next page

Specifications (continued)

Item	Specification
General purpose input / outputs	Setpoint range: 0.001–99.999 s, 1 ms resolution Accuracy: within $\pm 0.05\%$ of the selected time setting Repeatability: less than 16 μs at any time setting Number of outputs: 4 Number of inputs: 4 Outputs: isolated output switch, 5–24 VDC, 200 mA maximum Inputs: isolated input, 5–24 VDC, 20 mA maximum Setup method: (1) digital using the front panel keys or (2) remotely using a serial (RS-232C)
Heater outputs	Setpoint range: 0–100 °C (32–212 °F), 1 °C increments Indication accuracy: ± 2 °C, ± 1 digit Output: 24 VDC, 25 W maximum per channel Input: Type J thermocouple Sample rate: 16 per second Control method: PID Number of outputs: 2 Setup method: (1) digital using the front panel keys or (2) remotely using a serial cable (RS-232C) Other functions: Heater Alarm (non-latching / latching), Thermocouple Disconnect Alarm, Heater Fault Alarm (short-circuit)
Ambient operating conditions	Temperature: 5–45 °C (41–133 °F) Humidity: 85% RH at 30 °C, non-condensing Height above sea level: 2,000 m (6,562 ft) maximum
Product classification	Installation Category II Pollution Degree 2
Approvals	CE, TUV, RoHS, China RoHS, WEEE

RoHS标准相关声明 (China RoHS Hazardous Material Declaration)

产品名称 Part Name	有害物质及元素 Toxic or Hazardous Substances and Elements					
	铅 Lead (Pb)	汞 Mercury (Hg)	镉 Cadmium (Cd)	六价铬 Hexavalent Chromium (Cr6)	多溴联苯 Polybrominated Biphenyls (PBB)	多溴联苯醚 Polybrominated Diphenyl Ethers (PBDE)
外部接口 External Electrical Connectors	X	0	0	0	0	0
<p>0: 表示该产品所含有的危险成分或有害物质含量依照EIP-A, EIP-B, EIP-C的标准低于SJ/T11363-2006 限定要求。 Indicates that this toxic or hazardous substance contained in all the homogeneous materials for this part, according to EIP-A, EIP-B, EIP-C is below the limit requirement in SJ/T11363-2006.</p> <p>X: 表示该产品所含有的危险成分或有害物质含量依照EIP-A, EIP-B, EIP-C的标准高于SJ/T11363-2006 限定要求。 Indicates that this toxic or hazardous substance contained in all the homogeneous materials for this part, according to EIP-A, EIP-B, EIP-C is above the limit requirement in SJ/T11363-2006.</p>						

WEEE Directive



This equipment is regulated by the European Union under WEEE Directive (2012/19/EU). Refer to www.nordsonefd.com/WEEE for information about how to properly dispose of this equipment.

Operating Features

Front Panel Components

LCD display

Shows dispensing time, fluid pressure, temperature, parameter selections, and system status

DISPENSE key



Initiates a dispense cycle

Numeric keypad and ARROW keys



Use to enter settings. The arrow-shaped 2, 4, 6, and 8 keys are also used to move the cursor through the menu items shown on the LCD display.

Power switch

Turns the controller ON or OFF

F1, F2, and F3 function keys



Use to select the navigation or programming choices shown on the bottom of the LCD display, above the respective key. The choices vary depending on the current screen display and / or the mode.

ENABLE/ DISABLE key



Enables or disables the controller

ENTER key



Confirms the highlighted selection or the data entered

INCREASE (+)/ DECREASE (-) keys



Use to adjust any numeric parameter

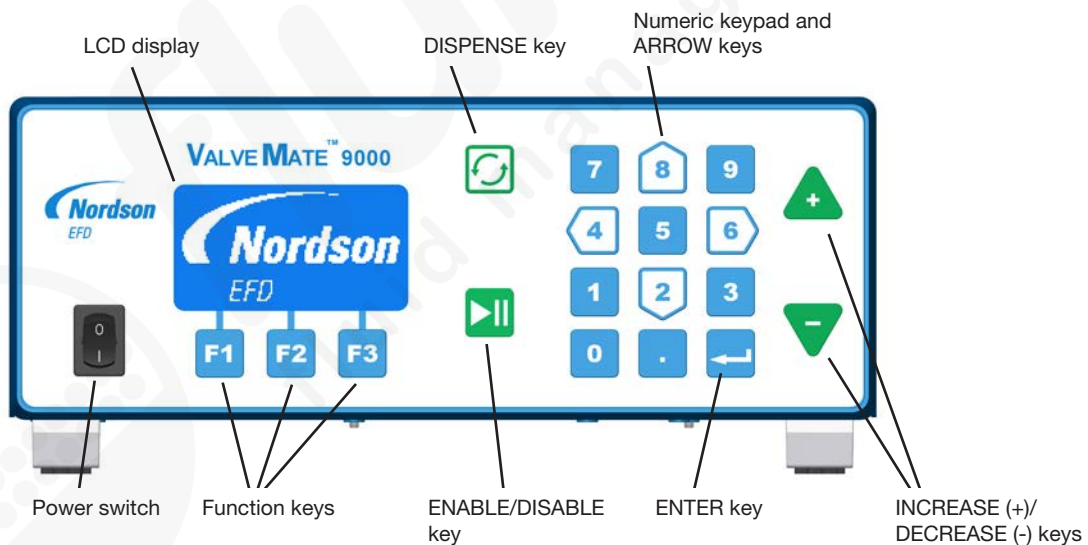

Operating Features (continued)

Back Panel Components

Foot pedal connection	Connection for the dispense valve actuating device
HEATER 1, HEATER 2, and DRV OUT connections	Connections for the heater and valve control for each channel
RS-232C connection	Connection for an RS-232C cable, which can be used to modify parameters from a PC or PLC
I/O connection	Connection for inputs and outputs (refer to Appendix B, "I/O Connector Pin Technical Data," for detailed information)
EXHAUST port	Quick-connection for the exhaust air from the electronic pressure regulators
AIR IN port	Quick-connection for the main air supply
AIR OUT ports	Quick-connections for the air output to the fluid reservoirs
AC power input	Power cord connection
Ground terminal	Ground wire connection

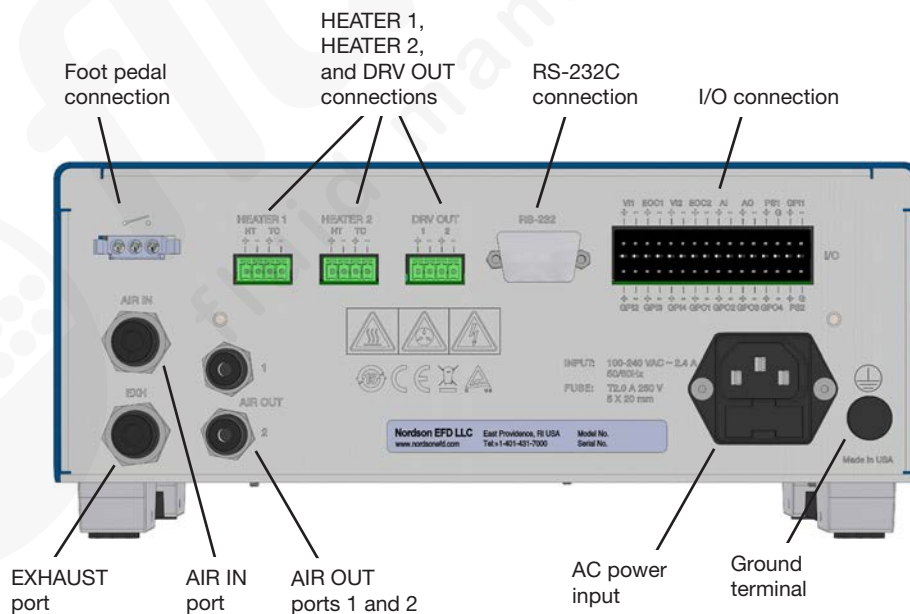

Operating Features (continued)

Back Panel Markings



Foot Pedal Connection Symbol

This symbol identifies the connector for a momentary contact closure switch for initiating a dispense cycle. An optional foot pedal is available.

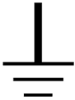

Chassis Connection Symbol

This symbol identifies the chassis connection terminal. Use this terminal for grounding the chassis to shunt leakage current and / or enhance system ESD protection.

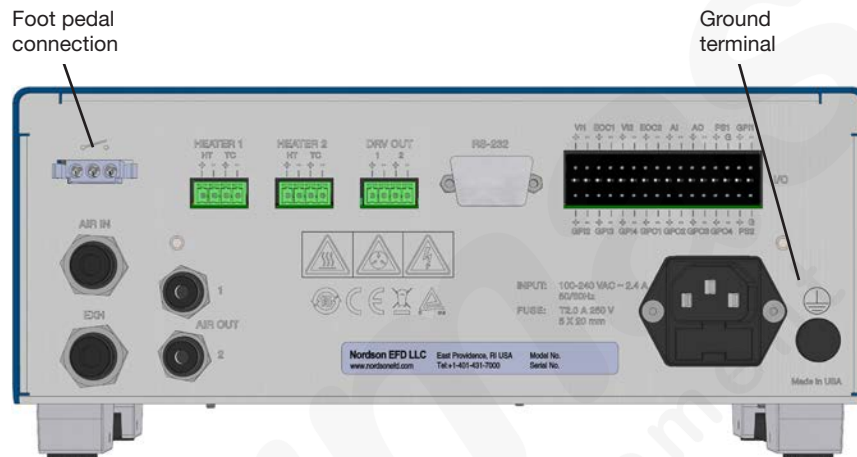

Installation

Key Components of a Typical Fluid Reservoir Installation

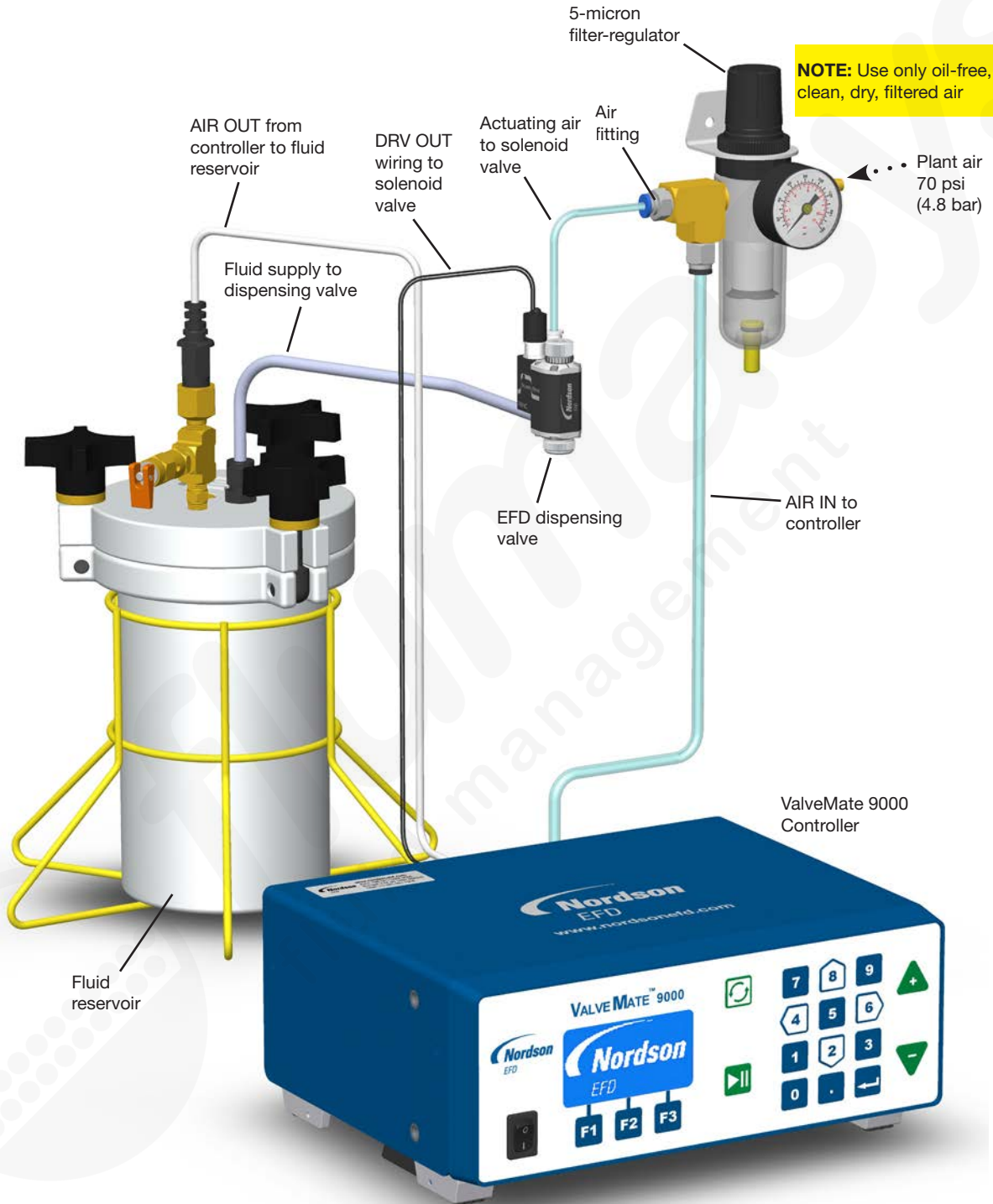

Installation (continued)

Unpack the Controller Components



- 1 Regulator, filter, air
- 2 Cable, RS-232C, DB9 receptacle, 2 m
- 3 Power cord, American plug
- 4 Fitting, 1/4 NPT x 6 mm OD
- 5 Tubing, 6 mm OD, blue urethane
- 6 Hex wrench, hex key, 4 mm
- 7 Connector, 4-position, P3.5 mm, female plug
- 8 Connector, 16-position, P3.5 mm, female plug

(Not Shown)

Quick-start guide

Installation (continued)

Install the Ancillary System Components

Install the components that will comprise the dispensing system. For example, if you are using a fluid reservoir, position and install the components shown under “Key Components of a Typical Fluid Reservoir Installation” earlier in this manual. For all ancillary system components, refer to the quick-start guide and / or operating manual provided with those components for installation, setup, and operating instructions.

Mount the Controller

If you want to use the optional mounting bracket (PN 7013556), install it on the controller. A drill hole pattern is provided below.

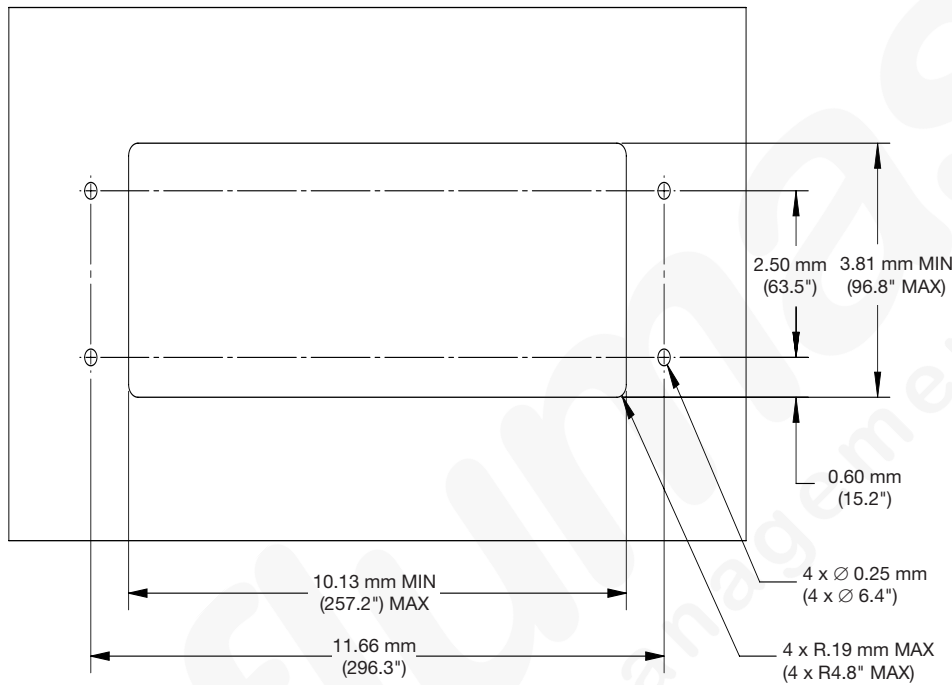

Mounting bracket drill pattern

Installation (continued)

Connect Power

NOTES:

- Use only the supplied power cord.
 - Ensure that the power source is located near the equipment and is easily accessible.
 - Use only on a circuit with a fuse or circuit breaker that is 20 A or less.
1. Connect the power cord to the back of the controller and to your local power source.
 2. Connect a 16 AWG (1.3 mm) wire to the chassis grounding screw on the rear of the chassis using a toothed grounding lug. The wire must have green insulation with a yellow stripe or must be noninsulated (bare).
 3. Attach the opposite end of the wire to a permanent earth ground using toothed washers or a toothed lug.

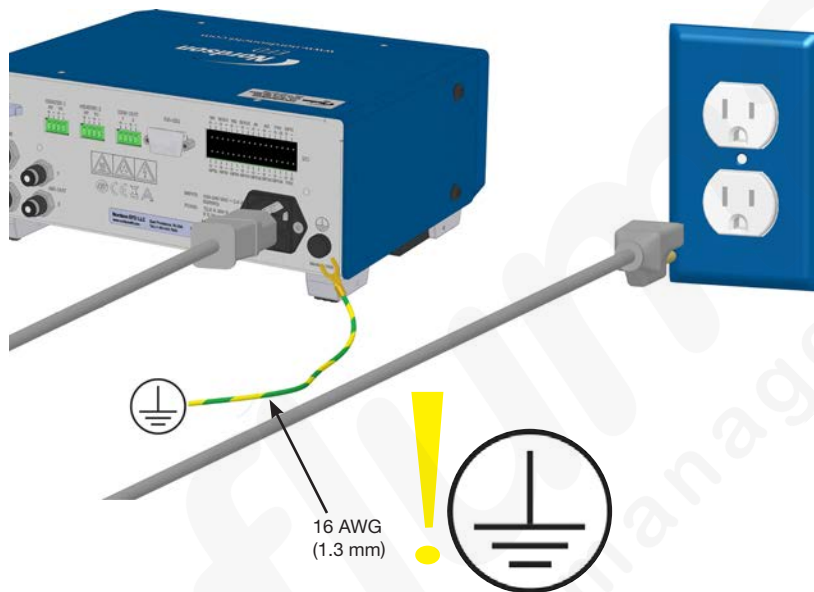

Installation (continued)

Connect Air

AIR OUT Connections

Connect 4-mm air line tubing from the AIR OUT 1 and 2 ports on the back of the controller to the syringe barrel(s) or fluid reservoir(s).

NOTE: Air output push-in fittings have an internal safety stop valve. Make sure the air line tubing is fully inserted into the fitting to allow proper air flow.

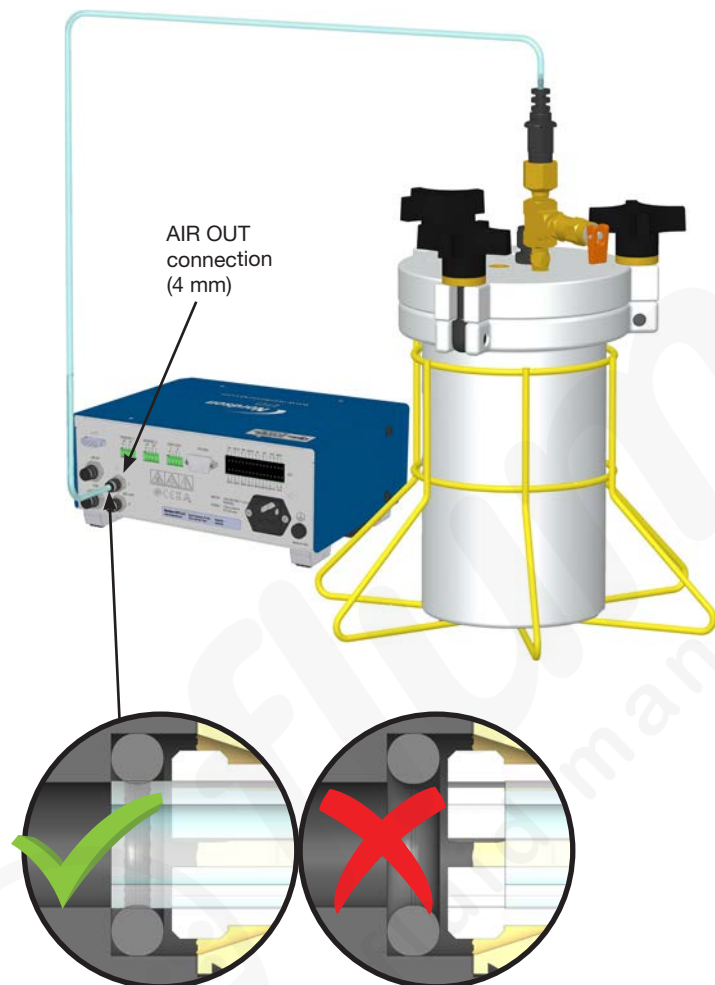

Installation (continued)

AIR IN Connection

NOTE: Clean, dry, filtered factory air is required to meet warranty.

1. Install the filter regulator (P/N 7002002) in the plant air supply line.
2. Install the air fitting (P/N 7022198) in the filter regulator output port.
3. Connect one end of the supplied 6-mm OD air line tubing to the P/N 7022198 air fitting.
4. Connect the other end of the tubing to the AIR IN connector on the back of the controller by pushing it firmly into the connector until it bottoms out. Make sure the line tubing is inserted all the way into the fitting.
5. Set the pressure at the filter regulator to 4.8–6.9 bar (70–100 psi).

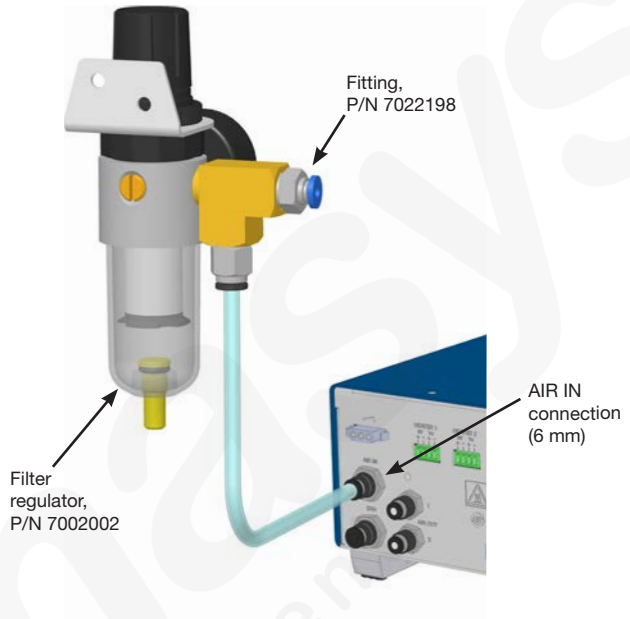

EXHAUST Connection

The EXHAUST port expels air from the electronic pressure regulators. Make sure the exhaust port is not restricted. If needed, connect air line tubing to the quick-connect fitting route the exhaust air to a remote location.

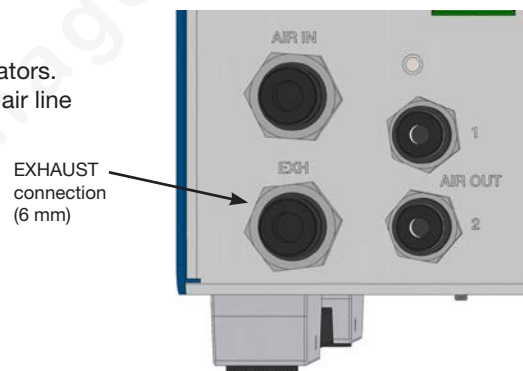

Installation (continued)

Connect Wiring

Connect a Dispense Valve Initiate Signal

Use either of the following methods to connect a dispense valve initiate signal:

- VI1, VI2 Terminals Use the supplied 16-position plug to connect a 5–24 VDC initiate signal to terminals VI1+ and VI2+ on the I/O connection (refer to “Connect General Purpose Inputs / Outputs”).

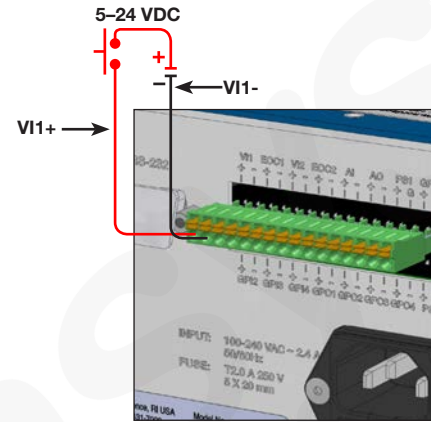

- Foot Pedal Connect the optional foot pedal (P/N 7014865) to the foot pedal switch connection.

NOTE: The foot pedal initiate signal is de-bounced for a period of 20 ms. To disable the de-bounce on the foot pedal signal, press the 5 key during power up or use the serial command through a serial cable (RS-232C).



Connect Driver Outputs

Use the supplied 4-position plug to connect each driver output signal to the solenoid valves for dispense valves 1 and 2.

The controller provides two driver outputs. Each output is 24 W, 5–24 VDC.

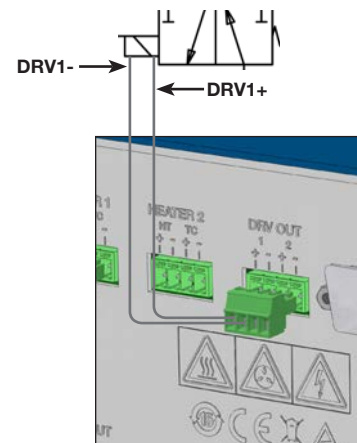

Installation (continued)

Connect Heater Outputs and Temperature Control Feedback

Use the supplied 4-position plugs to connect heater output and temperature control feedback signals to dispense valves 1 and 2.

The controller provides two heater outputs. Each output is 24VDC, 25 W maximum, with a maximum temperature setpoint of 100° C (212° F). Temperature control feedback is accomplished by a J-type thermocouple.

NOTES:

- To prevent malfunction, ensure that the thermocouple is in close thermal contact with the heater.
- Nordson EFD recommends using only heated valves that are compatible with this controller.

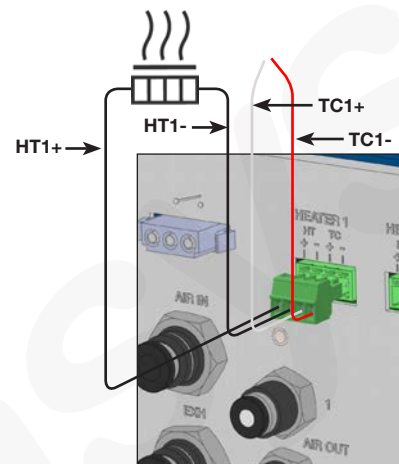

Installation (continued)

Connect General Purpose Inputs / Outputs

Use the supplied 16-position plugs to connect inputs and outputs as applicable for your operation. Refer to Appendix A, "I/O Connector Pin Technical Data" for detailed information.

The 32-pin I/O terminal strip includes the following inputs and outputs:

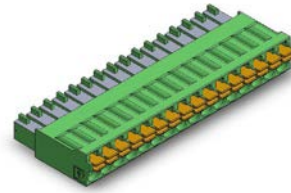

16-position plug

VI1, VI2	Voltage Initiate (VI) inputs — dispense initiate inputs activated with a 5–24 VDC input voltage
EOC1, EOC2	End-of-Cycle (EOC) feedback outputs — the EOC circuit is normally closed in the enabled mode, while the dispense cycle is inactive. The EOC switch opens when the dispense cycle is initiated and closes when the dispense cycle is completed. Upon completion of a dispense cycle, a solid state switch closes and remains closed until the next dispense cycle. The EOC feedback circuit can be used to signal back to a host computer, start another device in sequence, or initiate other operations that need to be tied to the completion of the dispense cycle.
AI	Alarm Input (AI) — when an AI open circuit is sensed, the controller flashes the System Alarm screen and prevents any further dispense cycles from initiating.
AO	Alarm Output (AO) — an AO signal can be triggered by an Auto Increment alarm, pressure alarm, heater alarm, heater fault alarm, thermocouple disconnect (TC) alarm, or an Alarm Input signal. When any of these alarm conditions occur (and are enabled), the controller sends an AO signal. Heater fault and TC alarms cannot be disabled.
PS1–2	Power Supply (PS) output — the PS outputs can be used to supply 24 VDC power to a voltage initiate, an external load, or to EOC and Alarm Out circuits for signalling purposes.
PS G (Ground)	24 VDC power supply output reference and return pins
GPI 1–4+	General Purpose Inputs (GPIs) — these inputs trigger a corresponding 24 VDC General Purpose Output when a 5–24 VDC signal appears across the pins.
GPI 1–4-	Isolated return path for the corresponding GPI+ pins
GPO 1–4+	General Purpose Outputs (GPOs) — these outputs turn on when triggered by the corresponding GPI.
GOI 1–4-	Isolated return path for the corresponding GPO+ pins

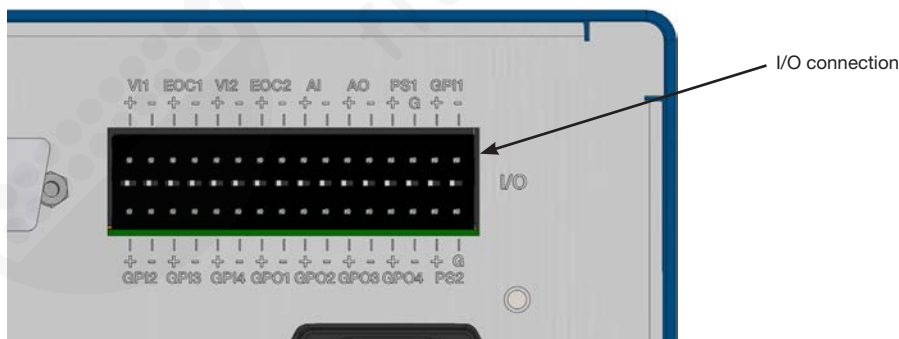

Installation (continued)

Check the Component Installation

1. Make sure:
 - The air pressure to the controller is set to 4.8–6.9 bar (70–100 psi). **1**
 - The dispense initiate and I/O connections are wired correctly. **2**
 - The dispense valves and fluid reservoir are properly connected. **3**
 - The valves are set up and dispensing tips are properly installed. **4**
2. Continue to “Setup” to enter controller settings. **5**



⚠ CAUTION

Always depressurize a fluid reservoir before opening. To do this, slide the shutoff valve on the air line away from the reservoir. If using an EFD fluid reservoir, open the pressure relief valve as well. Before opening the reservoir, check the pressure gauge to verify that the pressure is zero (0).

On all EFD cartridge reservoirs, the unique threaded design provides fail-safe air pressure release during cap removal.

Setup

Place the controller power switch in the ON position and use the procedures in this section to set up the controller for your operation. These procedures show data being entered manually. To use the PC interface software, refer to “Connecting the Controller to a Computer”.

About the MAIN Screen

When the controller is switched on, the MAIN screen appears after the logo screen.

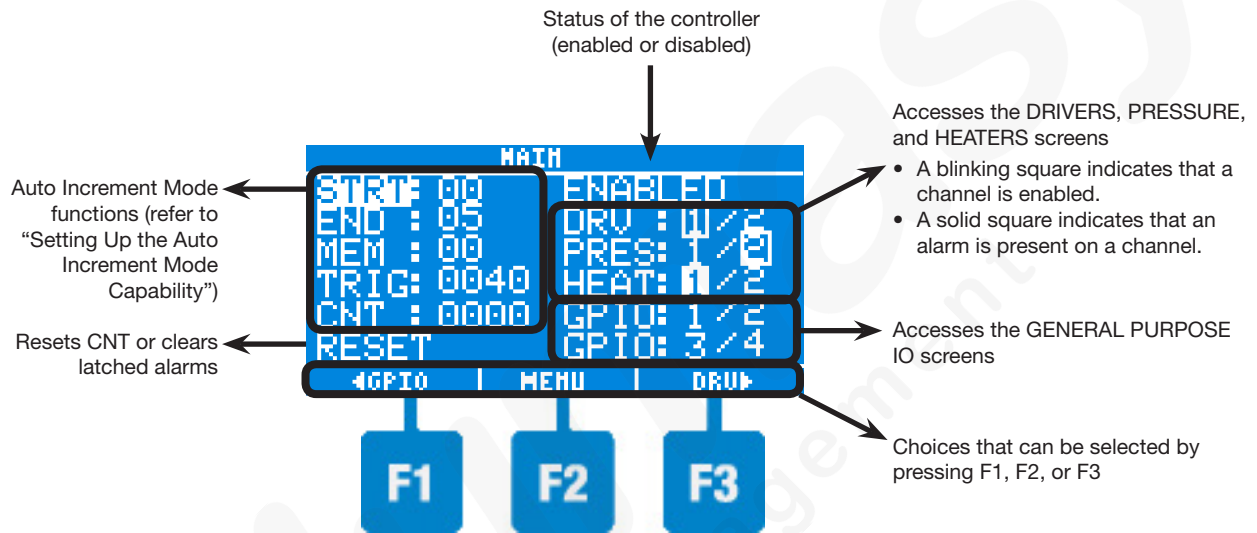

Setup (continued)

Navigating through the Controller Screens

Use the F1, F2, and F3 keys to select the choices shown on the bottom of the LCD display.

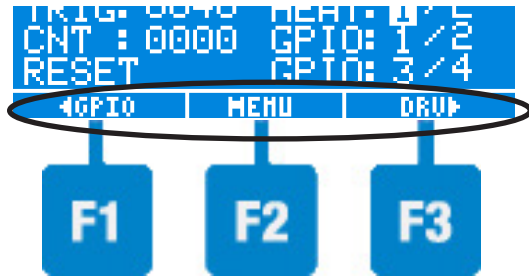

Use the keypad keys and the INCREASE (+)/DECREASE (-) keys to navigate through the menu items, change values, and enter selections.

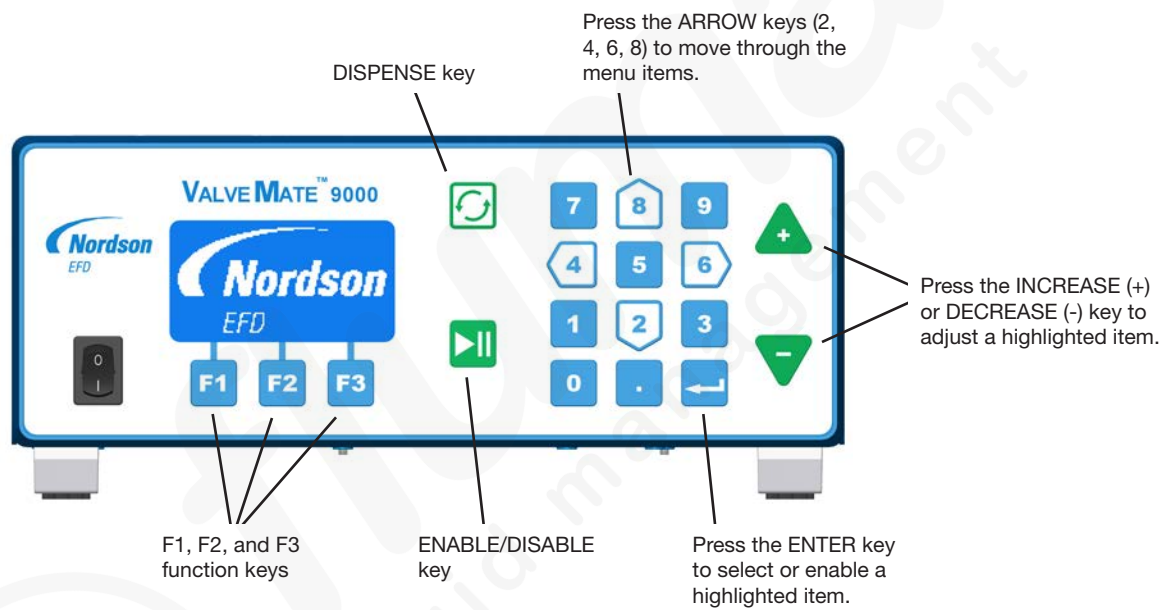

The VM9000 Controller Key Legend shows the terms used in this manual for each key.

VM9000 Controller Key Legend			
INCREASE (+) key		DECREASE (-) key	
ENTER key		DISPENSE key	
ARROW keys		ENABLE/DISABLE key	

Setup (continued)

Flowchart of Controller Screens

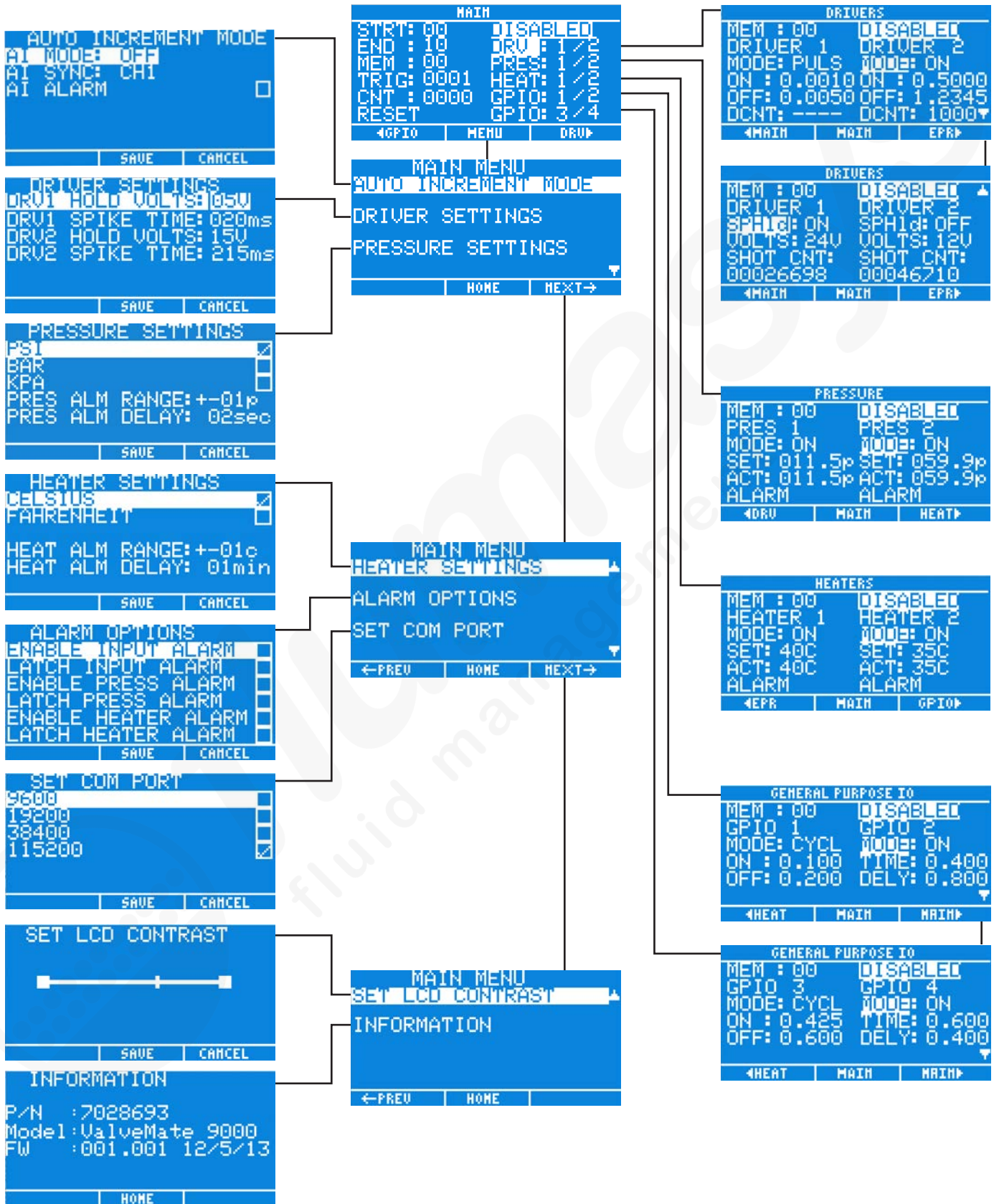

Setup (continued)

Connecting the Controller to a Computer

If desired, use the supplied RS-232C cable to connect the controller to a laptop, PC, or PLC. Refer to “Setting the RS-232C Baud Rate” to change the baud rate. Appendix B, “RS-232C Connection Protocol,” is provided for your reference as needed.



Setup (continued)

Enabling / Disabling the Controller

When first switched ON, the controller is automatically in the DISABLED mode.

To toggle between the DISABLED and ENABLED modes, press and hold the ENABLE/DISABLE key for 4 seconds.



ENABLE/DISABLE key

NOTE: Although the controller can be programmed in both the enabled and disabled modes, Nordson EFD strongly recommends programming the controller in the disabled mode to prevent erratic operation. Once all changes have been made, the controller can be enabled.

When ENABLED, the controller:

- Turns on the enabled pressure regulators and heater channels (refer to “Setting Up Pressure Control” and “Setting Up Heater Control”)
- Removes the flashing DISABLED indicator from the main screen and the functional block screens
- Accepts and processes signals from the drivers and general-purpose I/Os
- Enables the auto increment function, if enabled (refer to “Setting Up the Auto Increment Mode”)
- Accepts, processes, and indicates all alarms

When DISABLED, the controller:

- Turns off the pressure regulators, heaters, drivers, and general-purpose I/Os
- Resets the auto increment function (if AI MODE is ON)
- Resets all alarm states and removes the indicators from the LCD display
- Ignores all initiate signals, leaving all output signals disabled
- Ignores all alarm outputs
- Shows a blinking DISABLED indicator on the main screen and the functional block screens

Setup (continued)

Setting Units of Pressure

1. On the MAIN screen, press F2.
2. Use the ARROW keys to highlight PRESSURE SETTINGS, then press ENTER.
3. Use the ARROW keys to highlight PSI, BAR, or KPA, then press ENTER. A check mark appears in the box next to the selection, indicating that it is enabled.
4. Press F2 to save the change and return to the MAIN MENU.
5. Press F2 again to return to the MAIN screen.

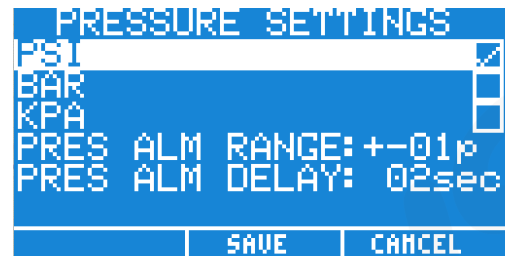

To cancel changes at any time and return to the MAIN MENU, press F3.

Setting Units of Temperature

1. On the MAIN screen, press F2.
2. Press F3 to move to the next screen.
3. Press ENTER to select HEATER SETTINGS.
4. Use the ARROW keys to highlight CELSIUS or FAHRENHEIT, then press ENTER. A check mark appears in the box next to the selection, indicating that it is enabled.
5. Press F2 to save the change and return to the MAIN MENU.
6. Press F2 again to return to the MAIN screen.



To cancel changes at any time and return to the MAIN MENU, press F3.

VM9000 Controller Key Legend

INCREASE (+) key		DECREASE (-) key	
ENTER key		DISPENSE key	
ARROW keys	,	ENABLE/DISABLE key	

Setup (continued)

Entering Driver Spike-and-Hold Settings

The spike-and-hold functionality is enabled by default. To disable the spike-and-hold functionality, refer to “Setting Up the Driver Outputs.” For technical details about the spike-and-hold functionality, refer to Appendix C, “Driver Spike-and-Hold Technical Data.”

1. On the MAIN screen, press F2.
2. Use the ARROW keys to highlight DRIVER SETTINGS, then press ENTER.
3. Use the ARROW keys to highlight the setting to be adjusted.
4. Press the INCREASE (+) or DECREASE (-) key to adjust the setting to the desired value. Refer to the “DRIVER SETTINGS Parameters” table for information on each parameter.
5. Press F2 to save the setting and return to the DRIVER SETTINGS menu.
6. Press F2 two more times to return to the MAIN screen.

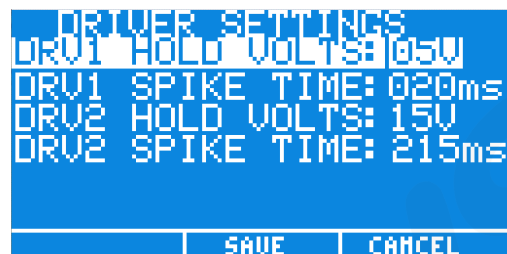

To cancel changes at any time and return to the MAIN MENU, press F3.







CAUTION

Risk of solenoid valve damage. If you are using dispense valve 745NC with a 24 W solenoid, Nordson EFD strongly recommends using the spike-and-hold functionality and not exceeding a DRV SPIKE TIME of 30 ms and a DRV HOLD VOLTS of 5 V.

DRIVER SETTINGS Parameters

Parameter	Range of Values	Description
DRV HOLD VOLTS	Default: 5 (V) Range: 5–24 (V, in 1 V increments)	The voltage the controller supplies to the corresponding driver after the DRV SPIKE TIME for that channel expires.
DRV SPIKE TIME	Default: 20 (ms) Range: 20–250 (ms, in 5 ms increments)	The amount of time the controller supplies the spike voltage to the corresponding driver. After the DRV SPIKE TIME expires, the voltage is throttled down to the voltage entered for DRV HOLD VOLTS. Refer to the VOLTS parameter under “Entering the Driver Output Settings” to set the spike voltage.

VM9000 Controller Key Legend

INCREASE (+) key		DECREASE (-) key	
ENTER key		DISPENSE key	
ARROW keys		ENABLE/DISABLE key	

Setup (continued)

Setting Up the Driver Outputs

1. On the MAIN screen, press the F1 or F3 keys until the first DRIVERS screen appears. The DRIVERS screens show both driver channels side by side.
2. Use the ARROW keys to highlight the parameter to be changed. To access the second DRIVERS screen, keep pressing the down ARROW (2) key.
3. Use the following methods to change a parameter:
 - MODE and SPHId: Press ENTER to change the selection.
 - ON, OFF, DCNT, and VOLTS: Press ENTER to change the selection by entering a value, or press the INCREASE (+) or DECREASE (-) key to adjust the value.

Refer to the “Driver Output Parameters” table for an explanation of each parameter.

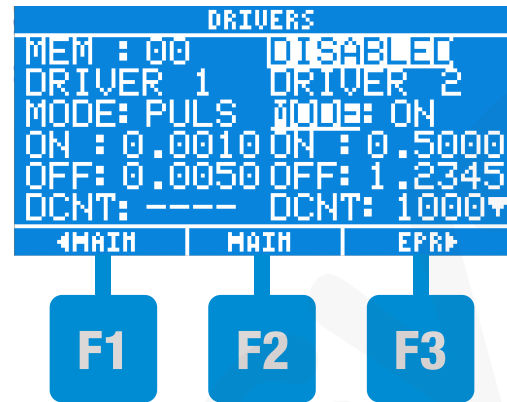

DRIVERS screen, page 1

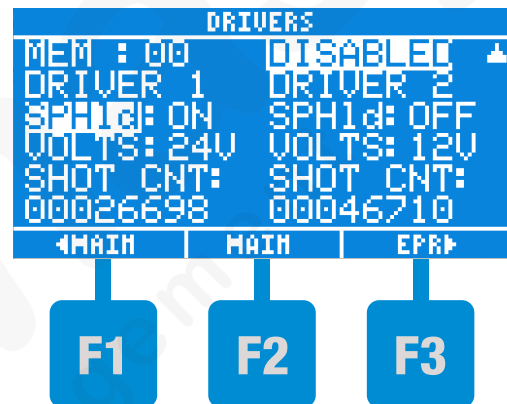

DRIVERS screen, page 2

VM9000 Controller Key Legend			
INCREASE (+) key		DECREASE (-) key	
ENTER key		DISPENSE key	
ARROW keys	,	ENABLE/DISABLE key	

Setup (continued)

Setting Up the Driver Outputs (continued)

Driver Output Parameters

Parameter	Range of Values	Description
MEM	00–99	Shows the current memory cell number. Refer to “Entering Memory Cell Settings” for information on memory cells.
MODE	OFF, ON, STDY, PULS	<p>OFF: The driver channel is off and will ignore the initiate signal.</p> <p>ON: The driver channel turns on for the number of seconds entered for ON and turns off for number of seconds entered for OFF. The driver immediately repeats the cycle for the number of cycles entered for DCNT.</p> <p>STDY: The driver stays on continuously until the initiate signal is deactivated. The ON, OFF, and DCNT parameters display - - - -.</p> <p>PULS: The driver continuously turns on and off (pulse) for the ON and OFF times until the initiate signal is deactivated, at which point the driver output turns off when ON is complete. DCNT displays - - - -.</p>
ON	0.0001–9.9999 [s, with a 100 μ s resolution (0.0001)]	The number of seconds the driver output turns on when an initiate signal is activated.
OFF	0.0001–9.9999 [s, with a 100 μ s resolution (0.0001)]	The number of seconds the driver output turns off once the number of ON seconds is complete.
DCNT	0001–9999 (cycles)	The number of times the driver channel repeats one ON and OFF cycle.
SPHld	OFF, ON	When SPHld is ON, the driver output performs a spike-and-hold operation for the spike time (20–250 ms) and then switches to the hold voltage (5–24 V). Refer to “Entering Driver Spike and Hold Settings” to enter spike time and hold voltage.
VOLTS	5–24 (V, in 1-V increments)	The output voltage the controller supplies to the drivers. If SPHld is OFF, this setting is the output voltage. If SPHld is ON, this setting is the spike voltage. Refer to “Entering Driver Spike and Hold Settings” to enter spike time and hold voltage.
SHOT CNT	00000000–99,999,999	This parameter counts the number of cycles the driver channel is activated. The SHOT CNT parameter increases by one for every cycle the driver is on, not every initiate. Press ENTER to reset SHOT CNT to 00000000.

Setup (continued)

Setting Up Pressure Control

- On the MAIN screen, press the F1 or F3 keys until the PRESSURE screen appears.. The screen shows both pressure control channels side by side.
- Use the ARROW keys to highlight the parameter to be changed. Use the following methods to change a parameter:
 - MEM and MODE: Press ENTER (↵) to change the selection.
 - SET: Press ENTER to change the selection by entering a value, or press the INCREASE (+) or DECREASE (-) key to adjust the value.

Refer to the “Pressure Control Parameters” table for an explanation of each parameter.

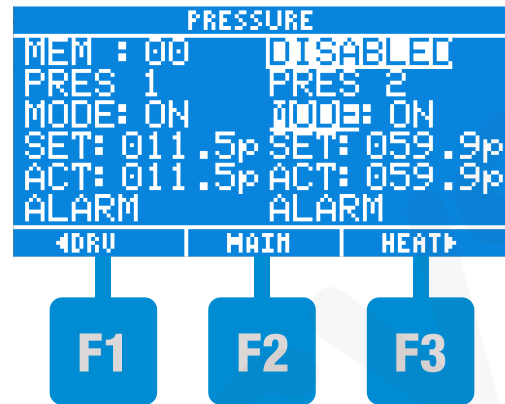

Pressure Control Parameters

Parameter	Range of Values	Description
MEM	00–99	Shows the current memory cell number. Refer to “Entering Memory Cell Settings” for information on memory cells.
MODE	OFF, ON	OFF: Sets the pressure regulator output to zero (0). ON: Enables the pressure regulator output. The pressure will be regulated to the value entered for SET.
SET	0–100 (psi), 0–6.9 (bar), or 0–069 (kpa) in intervals of 0.1 psi	Sets the pressure for the selected regulator.
ACT	–	Shows the actual pressure of the pressure channel.
ALARM	–	Refer to “Clearing Alarms.”

VM9000 Controller Key Legend

INCREASE (+) key		DECREASE (-) key	
ENTER key		DISPENSE key	
ARROW keys		ENABLE/DISABLE key	

Setup (continued)

Setting Up Heater Control

- On the MAIN screen, press the F1 or F3 keys until the HEATERS screen appears. The HEATERS screen shows both heater control channels side by side.
- Use the ARROW keys to highlight the parameter to be changed. Use the following methods to change a parameter:
 - MEM and MODE: Press ENTER to change the selection.
 - SET: Press ENTER to change the selection by entering a value, or press the INCREASE (+) or DECREASE (-) key to adjust the value.

Refer to the “Heater Control Parameters” table for an explanation of each parameter.

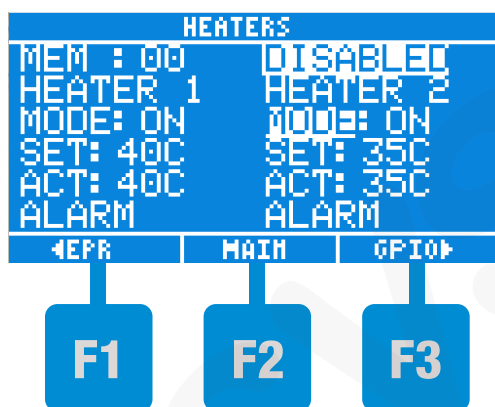

Heater Control Parameters

Parameter	Range of Values	Description
MEM	00–99	Shows the current memory cell number. Refer to “Entering Memory Cell Settings” for information on memory cells.
MODE	OFF, ON	OFF: Sets the heater output to OFF. ON: Enables the heater output. The heater will be regulated to the value entered for SET.
SET	00–100 (degrees C), or 32–212 (degrees F) in intervals of 1 degree C	Sets the temperature for the selected heater. NOTE: The controller converts the temperature setting to the nearest degree C if SET is entered in degrees F.
ACT	–	Shows the actual temperature of the heater channel.
ALARM	–	Refer to “Clearing Alarms.”

VM9000 Controller Key Legend

INCREASE (+) key		DECREASE (-) key	
ENTER key		DISPENSE key	
ARROW keys		ENABLE/DISABLE key	

Setup (continued)

Setting Up the General Purpose I/Os

1. On the MAIN screen, press the F1 or F3 keys until the first GENERAL PURPOSE IO screen appears. The GENERAL PURPOSE IO screens show the I/O channels side by side.
2. Use the ARROW keys to highlight the parameter to be changed. To access the second GENERAL PURPOSE IO screen, keep pressing the down ARROW key.
3. Use the following methods to change a parameter:
 - MEM and MODE: Press ENTER to change the selection.
 - TIME, DELY, ON, and OFF: Press ENTER (↵) to change the selection by entering a value, or press the INCREASE (+) or DECREASE (-) key to adjust the value.

Refer to the “GENERAL PURPOSE IO Parameters” table for an explanation of each parameter.

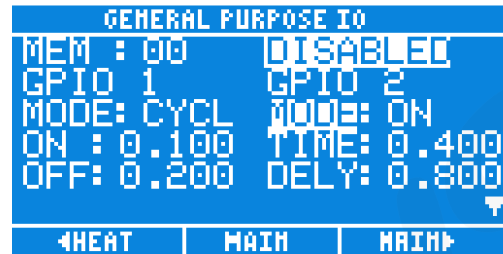

GENERAL PURPOSE IO screen, page 1

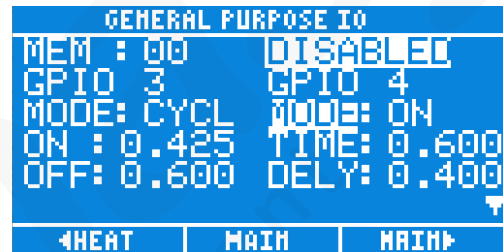

GENERAL PURPOSE IO screen, page 2

VM9000 Controller Key Legend			
INCREASE (+) key		DECREASE (-) key	
ENTER key		DISPENSE key	
ARROW keys	,	ENABLE/DISABLE key	

Setup (continued)

Setting Up the General Purpose I/Os (continued)

GENERAL PURPOSE IO Parameters

Parameter	Range of Values	Description
MEM	00-99	Shows the current memory cell number. Refer to “Entering Memory Cell Settings” for information on memory cells.
MODE	OFF, ON, STDY, CYCL	<p>OFF: The channel is off and will ignore the initiate signal.</p> <p>ON: The channel turns on after the number of seconds entered for DELY and remains on for number of seconds entered for TIME. If a second input signal is received any time during DELY or TIME, the channel immediately turns off.</p> <p>STDY: The delay function behaves the same as in the ON mode, but the output remains on until the input signal deactivates. The output will not turn on if the input signal is removed during the DELY time.</p> <p>CYCL: When a GPIO is set to this mode, TIME becomes ON and DELY becomes OFF for the selected GPIO. When an initiate signal is received on a GPIO that is set to CYCL, the GPIO turns on for ON seconds, turns off for OFF seconds, and automatically repeats the same ON and OFF cycle until the initiate signal is removed, at which point the GPIO remains on for the remainder of ON and then ignores the OFF time. The output will not turn on if the input signal is removed during OFF time.</p>
TIME (ON and STDY modes)	0.001 to 99.999 (s, in 1 ms increments)	The number of seconds that the channel remains on after the DELY time has passed.
DELY (ON and STDY modes)	0.001 to 99.999 (s, in 1 ms increments)	The number of seconds that will pass before the channel turns on after the signal is activated.
ON (CYCL mode)	0.001 to 99.999 (s, in 1 ms increments)	The number of seconds the channel turns on.
OFF (CYCL mode)	0.001 to 99.999 (s, in 1 ms increments)	The number of seconds the channel turns off.

Setup (continued)

Entering Memory Cell Settings

There are 100 unique memory cells in which different combinations of settings are stored. Refer to Appendix D, “Settings Stored in Memory Cells,” for a list of the settings stored. When the Auto Increment Mode is enabled, the controller uses the memory cells to automatically adjust its settings over time or as dispense cycles are initiated.

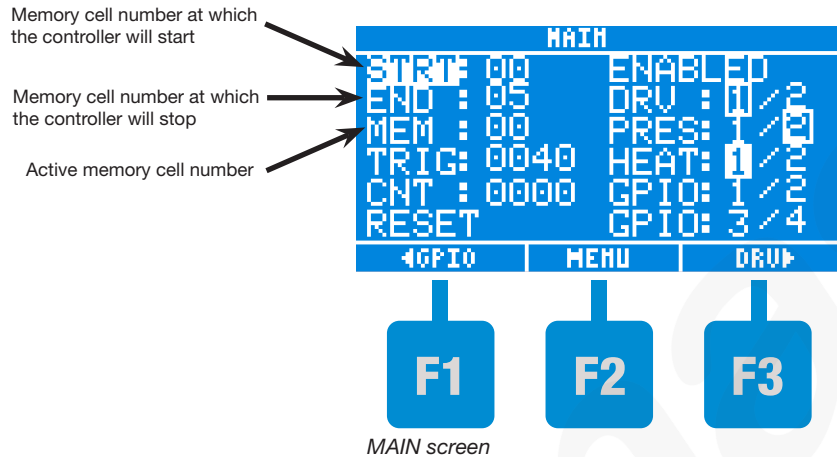

About Memory Cells

- The active memory cell number (MEM) is shown on the MAIN screen and on each of the functional block screens (DRIVERS, PRESSURE, HEATERS, and GENERAL PURPOSE IO).
- When you change to a different memory cell, all screens show the current settings stored in that cell.
- Any changes made to the TRIG setting or to the settings on each functional block screen will automatically replace the current settings for the memory cell shown.
- The memory cells at which the controller starts and stops when operating in the Auto Increment mode are shown as STRT and END on the MAIN screen.

To enter or change memory cell settings:

1. Verify that the MEM cell number for which you want to enter or change settings is displayed. A memory cell can be any number from 00–99.
2. Enter or change the desired settings. The controller automatically saves the entered settings on each of the functional block screens (DRIVERS, PRESSURE, HEATERS, or GENERAL PURPOSE IO) to the currently displayed MEM value.

To change to a different memory cell:

Use the ARROW keys to highlight MEM on any screen, then press ENTER or use the INCREASE (+)/ DECREASE (-) keys to change the MEM cell number. The settings for each of the functional block screens are loaded with the values stored for the currently-displayed memory cell location.

VM9000 Controller Key Legend			
INCREASE (+) key		DECREASE (-) key	
ENTER key		DISPENSE key	
ARROW keys		ENABLE/DISABLE key	

Setup (continued)

Setting Up the Auto Increment Mode

When operating in the Auto Increment Mode, the controller uses the data stored in the memory cells to automatically adjust its settings over time or as dispense cycles are initiated, thus compensating for fluid viscosity changes. Refer to “Entering Memory Cell Settings” to set up memory cells.

NOTE: For an example of how the Auto Increment mode works, refer to “Auto Increment Mode Example” on the next page.

1. On the MAIN screen, press F2.
2. Press ENTER to select AUTO INCREMENT MODE.
3. Press ENTER until the desired Auto Increment Mode is selected. Refer to the “AUTO INCREMENT MODE Parameters” table for an explanation of each parameter.
4. Press the down ARROW key to highlight AI SYNC.
5. Press ENTER until the desired channel is selected. Refer to the “AUTO INCREMENT MODE Parameters” table for an explanation of each parameter.
6. Press F2 to save the change and return to the MAIN MENU.
7. Press F2 again to return to the MAIN screen.



To cancel changes at any time and return to the MAIN MENU, press F3.

VM9000 Controller Key Legend			
INCREASE (+) key		DECREASE (-) key	
ENTER key		DISPENSE key	
ARROW keys		ENABLE/DISABLE key	

Setup (continued)

Setting Up the Auto Increment Mode (continued)

Auto Increment Mode Example

This example shows the memory cell settings that would be a good starting point for a dispensing fluid that changes viscosity over time.

NOTES:

- When dispensing fluids that change viscosity, it is generally better to set AI MODE to TIME instead of COUNT.
- It is good practice to use small pressure adjustments or allow some settling time to ensure consistent deposit amounts.

Initial memory cell settings:

- Cell 0 — Enter parameters to produce the desired dot size. For example:
 - DRIVERS screen: Set MODE to ON.
 - DRIVERS screen: Set the ON (dispense) time to 0.150 seconds.
 - DRIVERS screen: Set the OFF time to 0.1000 seconds.
 - DRIVERS screen: Set the shot count (DCNT) to 1 (only one dispense cycle).
 - PRESSURE screen: Set MODE to ON.
 - PRESSURE screen: Set the pressure (SET) to 20 psi).
 - MAIN screen: Set the trigger value (TRIG) to 3600 seconds (1 hour).
- Cell 1 — Increase the SET pressure to 23 psi and increase ON time to 0.175 seconds. Set TRIG to 2700 seconds (45 minutes).
- Cell 2 — Increase the SET pressure to 27 psi and increase ON time to 0.200 seconds. Set TRIG to 1800 seconds (30 minutes).

Set up the Auto Increment mode as follows:

1. Set AI MODE to TIME.
2. Set start (STRT) at memory cell 0.
3. Set end (END) at memory cell 2.

How the system will operate with the above settings:

NOTE: Enable the controller to test settings.

After the first 3600 seconds elapse (when CNT equals 3600), the controller increments to memory cell 1, in which PRES increases to 23 psi and ON time increases to 0.175 seconds.

When CNT reaches 2700, the controller increments to memory cell 2, in which PRES increases to 27 psi and ON time increases to 0.200 seconds.

If the AI ALARM is DISABLED, the controller continues using the settings saved in memory cell 2 until the operator selects RESET on the MAIN screen and presses the ENTER key twice.

If AI ALARM is ENABLED, the AI System Alarm screen flashes and the controller prevents any further initiate cycles until the operator selects RESET on the MAIN screen and presses the ENTER key twice. After a reset, the controller returns to the STRT memory cell and CNT resets to 0000.

Setup (continued)

Setting Up the Auto Increment Mode (continued)

Auto Increment Mode Parameters

Parameter	Range of Values	Description
AI MODE	OFF, TIME, COUNT, SEQ	<p>OFF: The Auto Increment Mode is turned off.</p> <p>TIME: The controller automatically adjusts settings to compensate for viscosity changes by moving to the next memory cell based on the number of seconds that have elapsed.</p> <p>COUNT: The controller automatically adjusts settings to compensate for viscosity changes by moving to the next memory cell based on the number of dispensing cycles.</p> <p>SEQ (Auto Sequence): Similar to the COUNT mode except that the memory cell address automatically resets and continues from the start once the end is reached.</p> <p>NOTE: When the Auto Increment Mode is set to TIME, COUNT, or SEQ, the following parameters are enabled on the MAIN screen: STRT, END, TRIG, and CNT.</p>
STRT	00–99	The memory cell at which the Auto Increment Mode will start.
END	00–99	The memory cell at which the Auto Increment Mode will stop.
TRIG	1–9999	The number of dispensing cycles or the time that must pass before a memory cell increases to the next address. Each memory cell has its own trigger value. Therefore, as the memory cell address increases, a new trigger value is loaded for that memory cell. Any changes made to the trigger value in a specific memory cell will automatically save the trigger value to that memory cell.
CNT	–	The controller has two methods of incrementing the CNT parameter. When the AI MODE is set to TIME, CNT increases by one every second. When the AI MODE is set to COUNT or SEQ, CNT increments by one for every initiate signal on the selected channel (refer to AI SYNC). When CNT equals the value entered for TRIG, the MEM cell address advances by one and CNT resets to 0000.
RESET	–	Clears an AI alarm. Refer to “Clearing Alarms.”
AI SYNC	CH1, CH2	<p>If AI MODE is set to COUNT, use AI SYNC to sync the Auto Increment Mode to channel 1 (CH1) or channel 2 (CH2). Sync has no effect if AI MODE is set to TIME.</p> <p>Example: Set AI SYNC to CH2 if you want to tie the Auto Increment Mode to the number of shots dispensed from Driver 2 instead of Driver 1.</p>

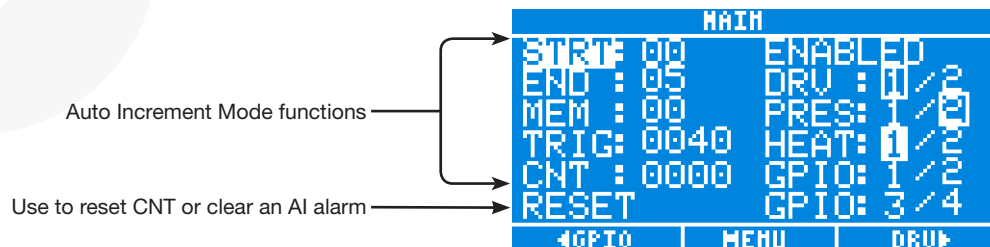

Setup (continued)

Entering the Auto Increment Mode Alarm Setting

1. On the MAIN screen, press F2.
2. Press ENTER to select AUTO INCREMENT MODE.
3. To enable the Auto Increment Mode alarm, use the down ARROW key to highlight AI ALARM, then press ENTER. A check mark appears in the box next to the selection, indicating that it is enabled.
 - If AI MODE is set to TIME or COUNT and AI ALARM is enabled, the controller generates an alarm when the current memory cell is END and TRIG has reached its required count. The controller will not allow any further initiates until you press RESET twice on the MAIN screen. Refer to “Setting Up the Auto Increment Mode” to use the Auto Increment Mode functionality.
 - If AI MODE is set to TIME or COUNT and AI ALARM is disabled, the controller continues using the parameters of the END memory cell until you press RESET twice on the MAIN screen.
4. Press F2 to save the change and return to the MAIN MENU.
5. Press F2 again to return to the MAIN screen.



To cancel changes at any time and return to the MAIN MENU, press F3.



Auto Increment Mode System Alarm screen

VM9000 Controller Key Legend

INCREASE (+) key		DECREASE (-) key	
ENTER key		DISPENSE key	
ARROW keys		ENABLE/DISABLE key	

Setup (continued)

Entering Pressure Alarm Settings

1. On the MAIN screen, press F2 .
2. Use the ARROW keys to highlight PRESSURE SETTINGS, then press ENTER.
3. Use the ARROW keys to highlight PRES ALM RANGE or PRES ALM DELAY, then press ENTER.
 - Pressure Alarm Range — if the actual pressure falls above or below the range specified by this setting, a pressure alarm is generated.
 - Pressure Alarm Delay — the amount of time that the actual pressure may fall above or below the pressure alarm range before a pressure alarm is generated.
4. Use the INCREASE (+)/DECREASE (-) keys to change the parameter value. The value must be within the ranges shown below.
 - Pressure Alarm Range: +/- 1–10 psi (+/- 0.07–0.69 bar, +/- 7–69 kPa)
 - Pressure Alarm Delay: 00–99 (s)
5. Press F2 to save the changes and return to the MAIN MENU.
6. Press F2 again to return to the MAIN screen.
7. Refer to “Setting Alarm Output Options” to enable / disable and latch alarms.

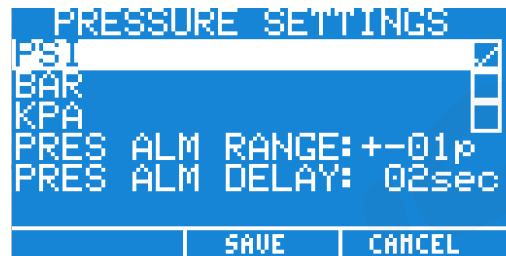

To cancel changes at any time and return to the MAIN MENU, press F3.



Pressure System Alarm screen

VM9000 Controller Key Legend

INCREASE (+) key		DECREASE (-) key	
ENTER key		DISPENSE key	
ARROW keys		ENABLE/DISABLE key	

Setup (continued)

Entering Heater Alarm Settings

1. On the MAIN screen, press F2.
2. Press F3 to continue to the next screen.
3. Use the ARROW keys to highlight HEATER SETTINGS, then press ENTER.
4. Use the ARROW keys to highlight HEAT ALM RANGE or HEAT ALM DELAY, then press ENTER.
 - Heater Alarm Range — if the actual dispense valve temperature falls above or below the range specified by this setting, a heater alarm is generated.
 - Heater Alarm Delay — the amount of time that the actual dispense valve temperature may fall above or below the heater alarm range before a heater alarm is generated.
5. Use the INCREASE (+)/DECREASE (-) keys to change the parameter value. The value must be within the ranges shown below.
 - Heater Alarm Range: 1–10° C (1–10° F)
 - Heater Alarm Delay: 00–99 (min)
6. Press F2 to save the changes and return to the MAIN MENU.
7. Refer to “Setting Alarm Output Options” to enable / disable and latch alarms.

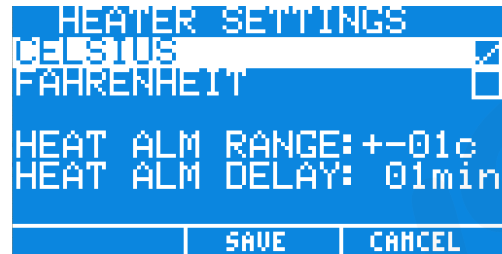

To cancel changes at any time and return to the MAIN MENU, press F3.



Heat system Alarm screen

VM9000 Controller Key Legend			
INCREASE (+) key		DECREASE (-) key	
ENTER key		DISPENSE key	
ARROW keys		ENABLE/DISABLE key	

Setup (continued)

Setting Alarm Options

1. On the MAIN screen, press F2.
2. Press F3 to scroll to the next screen.
3. Use the ARROW keys to highlight ALARM OPTIONS, then press ENTER.
4. Use the ARROW keys to highlight the desired selection, then press ENTER. A check mark appears in the box next to the selection, indicating that it is enabled.

Refer to “How the Alarm Options Function” table for an explanation of each selection.

When an alarm is generated, the System Alarm screen flashes. Refer to “Clearing Alarms” for instructions on clearing unlatched and latched alarms.

5. Press F2 to save the changes and return to the MAIN MENU.
6. Press F2 again to return to the MAIN screen.

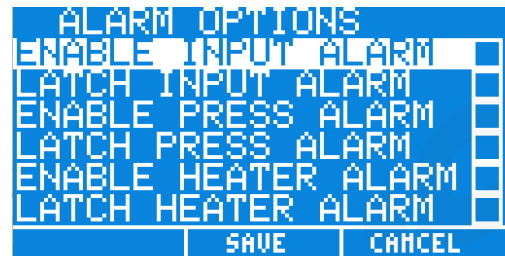

To cancel changes at any time and return to the MAIN MENU, press F3.



Input Alarm System Alarm screen

VM9000 Controller Key Legend			
INCREASE (+) key		DECREASE (-) key	
ENTER key		DISPENSE key	
ARROW keys		ENABLE/DISABLE key	

Setup (continued)

Setting Alarm Options (continued)

How the Alarm Options Function When Enabled

Parameter	Description
ENABLE INPUT ALARM	Alarm Input has the highest priority. When the Alarm Input signal is activated, the controller generates an alarm and disables all dispensing operations, including heaters, drivers, pressure control, and general-purpose I/Os. NOTE: For this alarm to generate, Alarm Input signal wiring must be connected to the I/O terminal block. Refer to “Connect General Purpose Inputs/Outputs.”
LATCH INPUT ALARM	When Alarm Input is latched, an input alarm can be cleared only by selecting RESET and pressing ENTER two times on the MAIN screen, after the cause of the alarm has been removed. Refer to “Clearing Alarms.”
ENABLE PRESS ALARM	If the actual pressure falls outside the acceptable pressure range for longer than the Pressure Alarm Delay (refer to “Entering Pressure Alarm Settings”), the controller generates an alarm. The alarm will clear and the Pressure Alarm Delay will reset when the actual pressure returns to the acceptable range.
LATCH PRESS ALARM	When a pressure alarm is latched, it can be cleared only two ways: (1) by selecting ALARM on the PRESSURE screen and pressing ENTER or (2) by selecting RESET on the MAIN screen and pressing ENTER two times, after the cause of the alarm has been removed. Refer to “Clearing Alarms.”
ENABLE HEATER ALARM	If the actual temperature of a heater falls outside the acceptable temperature range for longer than the Heater Alarm Delay (refer to “Entering Heater Alarm Settings”), the controller generates an alarm. The alarm will clear and the Heater Alarm Delay will reset when the actual temperature returns to the acceptable range.
LATCH HEATER ALARM	When a heater alarm is latched, it can be cleared only two ways: (1) by selecting ALARM on the HEATERS screen and pressing ENTER, or (2) by selecting RESET on the MAIN screen and pressing ENTER two times, after the cause of the alarm has been removed. Refer to “Clearing Alarms.”

Setup (continued)

Setting the RS-232C Baud Rate

1. On the MAIN screen, press F2.
2. Press F3 to scroll to the next MAIN MENU screen.
3. Use the ARROW keys to highlight SET COM PORT, then press ENTER.
4. Use the ARROW keys to highlight the desired baud rate, then press ENTER. A check mark appears in the box next to the selection, indicating that it is selected. The following baud rates may be selected:
 - 9600
 - 19200
 - 38400
 - 115200 (default)
5. Press F2 to save the changes and return to the MAIN MENU.
6. Press F2 again to return to the MAIN screen.



To cancel changes at any time and return to the MAIN MENU, press F3.



VM9000 Controller Key Legend			
INCREASE (+) key		DECREASE (-) key	
ENTER key		DISPENSE key	
ARROW keys		ENABLE/DISABLE key	

Setup (continued)

Adjusting the LCD Contrast

1. On the MAIN screen, press F2.
2. Press F3 two times to scroll to the third MAIN MENU screen.
3. Use the INCREASE (+)/DECREASE (-) keys to set the desired contrast.
4. Press F2 to save the changes and return to the MAIN MENU.
5. Press F2 again to return to the MAIN screen.

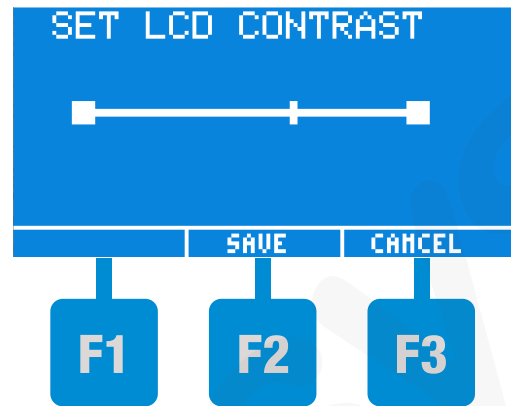

To cancel changes at any time and return to the MAIN MENU, press F3.

Viewing the Controller Part Number and Firmware Revision Level

1. On the MAIN screen, press F2.
2. Press F3 two times to scroll to the third MAIN MENU screen.
3. Use the ARROW keys to highlight INFORMATION, then press ENTER. The LCD display shows the equipment part number and the firmware revision level and date.
4. Press F2 to return to the MAIN screen.

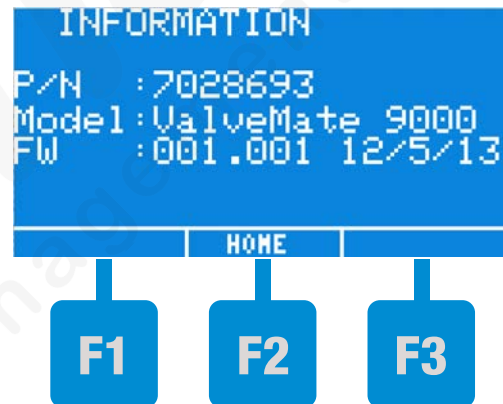

VM9000 Controller Key Legend

INCREASE (+) key		DECREASE (-) key	
ENTER key		DISPENSE key	
ARROW keys		ENABLE/DISABLE key	

System Startup and Operation

NOTE: The illustration callouts on the next page correspond to the steps in this procedure.

1. On the PRESSURE screen, verify the SET pressure value. Use low pressure (approximately 5 psi) for low-viscosity materials and higher pressure (approximately 15 psi) for high-viscosity materials.
2. Press and hold the ENABLE/DISABLE key for 4 seconds.



ENABLE/DISABLE key







3. On the DRIVERS screen for the dispense valve being tested, set the mode to STDY.
4. Press and hold the DISPENSE key. Allow material to flow until all air is purged from the system, then release the DISPENSE key.
5. Adjust the fluid pressure, or the valve stroke knob, to set a flow rate that is neither too low nor too high. A high flow rate will make setting up a small dot difficult or could cause splashing. Refer to the dispense valve operating manual to adjust the valve for system startup.

CAUTION

Risk of solenoid valve damage. If you are using dispense valve 745NC with a 24 W solenoid, Nordson EFD strongly recommends using the spike-and-hold functionality and not exceeding a DRV SPIKE TIME of 30 ms and a DRV HOLD VOLTS of 5 V. Refer to “Entering Driver Spike-and-Hold Settings” earlier in this manual.

6. On the DRIVERS screen, enter the following settings for the dispense valve being tested:
 - MODE: ON
 - ON : 0.0500 seconds
 - OFF: 0.0010 seconds
 - DCNT: 1
7. Press the DISPENSE key again to initiate another dispense cycle. Increase or decrease the dispense (ON, OFF) time or the fluid pressure to arrive at the desired deposit size. The primary control of the deposit size is the valve open (ON) time.
8. The system is now ready to be initiated by the machine controls when the machine is started.

VM9000 Controller Key Legend

INCREASE (+) key		DECREASE (-) key	
ENTER key		DISPENSE key	
ARROW keys	 	ENABLE/DISABLE key	

Clearing Alarms

Clearing a Pressure or Heater Alarm

When a pressure or heater alarm occurs, a solid square is displayed on the channel number and the corresponding SYSTEM ALARM screen flashes.



A solid square indicates that an alarm is present on a channel.

If a pressure or heater alarm is not latched, the alarm clears automatically when the actual pressure or dispense valve temperature returns to the specified range.

To Clear a Latched Alarm:

If a pressure or heater alarm is latched, resolve the cause of the alarm (if needed), then use one of the following methods to clear the alarm:

- On the PRESSURE or HEATERS screen, use the ARROW keys to select ALARM, then press ENTER.
- On the MAIN screen, use the ARROW keys to select RESET, then press ENTER two times.

NOTE: Refer to “Entering Pressure Alarm Settings” and “Entering Heater Alarm Settings” to enable alarms. Refer to “Setting Alarm Options” to latch or unlatch alarms.



Flashing Pressure System Alarm screen



Flashing Heater System Alarm screen

Clearing Alarms (continued)

Clearing an Alarm Input or Auto Increment Mode Alarm

When an Input Alarm or Auto Increment Mode alarm occurs, the corresponding SYSTEM ALARM screen flashes.

If an Input Alarm is not latched, the alarm clears automatically when the cause of the alarm is resolved (either on its own or through operator action).

To Clear a Latched Input Alarm:

If an Input Alarm is latched, resolve the cause of the alarm (if needed), then use the following method to clear the alarm:

- On the MAIN screen, use the ARROW keys to select RESET, then press ENTER two times.

To Clear a Latched Auto Increment Mode Alarm:

If an Auto Increment Mode alarm occurs, clear the alarm as follows:

- On the MAIN screen, use the ARROW keys to select RESET, then press ENTER two times.

The controller returns to the STRT memory cell and CNT resets to 0000.

NOTE: Refer to “Connect General Purpose Inputs/Outputs” to connect external alarm inputs to the controller. Refer to “Setting Alarm Options” to latch or unlatch an Alarm Input alarm. Refer to “Entering the Auto Increment Mode Alarm Setting” to enable the Auto Increment Mode alarm.



Flashing Input Alarm System Alarm screen



Flashing Auto Increment Mode System Alarm screen

Clearing Alarms (continued)

Clearing a Heater Fault Alarm

The Heater Fault alarm is a non-adjustable alarm. Its main purpose is to allow safe operation of the heater output circuits. When a Heater Fault alarm occurs, the controller immediately switches off both heater outputs until the alarm is cleared.

This alarm can occur under the following conditions:

- If a heater short circuit or an over-current condition is present at either heater output
NOTE: The maximum allowable power limit for each heater is 25 W.
- If a thermocouple disconnect condition occurs. The controller monitors the ACT temperature reading versus the SET temperature value for a one-minute period. If, within this one-minute period, the ACT and SET values are not within 10 °C of one another, a Heater Fault Alarm is generated.

To Clear a Heater Fault Alarm:

1. If the Heater Fault alarm was caused by a short circuit or over-current condition, identify the cause and correct the condition by removing the short circuit or removing the over-current condition.
2. If the Heater Fault alarm was caused by a thermocouple disconnect condition, inspect the system to ensure that the heaters and thermocouples are thermally connected. In addition, perform an inspection of the wiring and hardware integrity.
3. When the condition that caused the Heater Fault alarm is manually cleared, select ALARM for the affected heater channel (on the HEATERS screen) and press ENTER to clear the alarm.

NOTES:

- If a heated valve requires more than 1 minute to reach a temperature that is within 10° C of its SET temperature, gradually increase the SET temperature to allow the controller enough time to reach the desired temperature setting. In a normal, room-temperature environment, Nordson EFD valves rarely require more than 1 minute to be within 10° C of SET temperature.
- The time allowed for a heated valve to reach a temperature that is within 10° C of its SET temperature can be adjusted externally by changing the SET HEATER FAULT TIME (htft) command through an RS-232C computer connection. Refer to “Connecting the Controller to a Computer” and Appendix B, “RS-232C Connection Technical Information.”



Flashing Heater Fault
System Alarm

Clearing Alarms (continued)

Clearing a Thermocouple (TC) Fault Alarm

The TC Fault alarm is a non-adjustable alarm. Its main purpose is to alert the operator that while a heater was on, the controller lost feedback from the thermocouple. When a TC Fault alarm is generated, the controller immediately switches off both heater outputs until the alarm is cleared.

This alarm occurs when the unit is enabled, a heater channel is turned ON, and the controller does not detect a correct thermocouple reading from the corresponding heater channel that is actively ON.

NOTE: The ACT field on the HEATERS screen displays “----” when the controller does not detect a correct reading from the thermocouple.



The most likely causes of a TC Fault alarm are a broken thermocouple wire or incorrect HEATER 1 or HEATER 2 TC connections.

To Clear a TC Fault Alarm:

1. Check the integrity of the wiring between the thermocouple and the HEATER 1 or HEATER 2 TC connections to the rear of the controller.
2. Verify that the ACT field on the HEATERS screen is not displaying “----.”
3. On the HEATERS screen, select either ALARM and press ENTER to clear the alarm.

NOTE: You can also clear a TC Fault alarm by pressing the ENABLE/DISABLE key to disable the controller.



Flashing TC Fault
System Alarm

Part Number

Part #	Description
7028693	ValveMate 9000 Controller

Replacement Parts

Item	Part #	Description
1	7029775	KIT, ELECTRONIC REGULATOR, VM9000
2	7029773	KIT, MAIN PC BOARD, VM9000
3	7029777	KIT, POWER SUPPLY, VM9000
4	7026518	KIT, FITTING, 4 MM, BULKHEAD (2)
5	7029776	KIT, FITTING, 6 MM, BULKHEAD (2)
6	7029772	KIT, PLUG, TERMINAL BLOCK, VM9000 (5)
7	7026524	KIT, M4 X 20 MM, THUMB SCREW ASSEMBLY
8	7029774	KIT, REPLACEMENT FUSES, VM9000 (2) (for the AC power cord plug)
9	7029778	KIT, BEZEL AND OVERLAY, VM9000
10	7014547	KIT, POWER SWITCH, ULTIMUS V
(Not Shown)	7013556	KIT, PANEL MOUNT (mounting bracket for the controller)

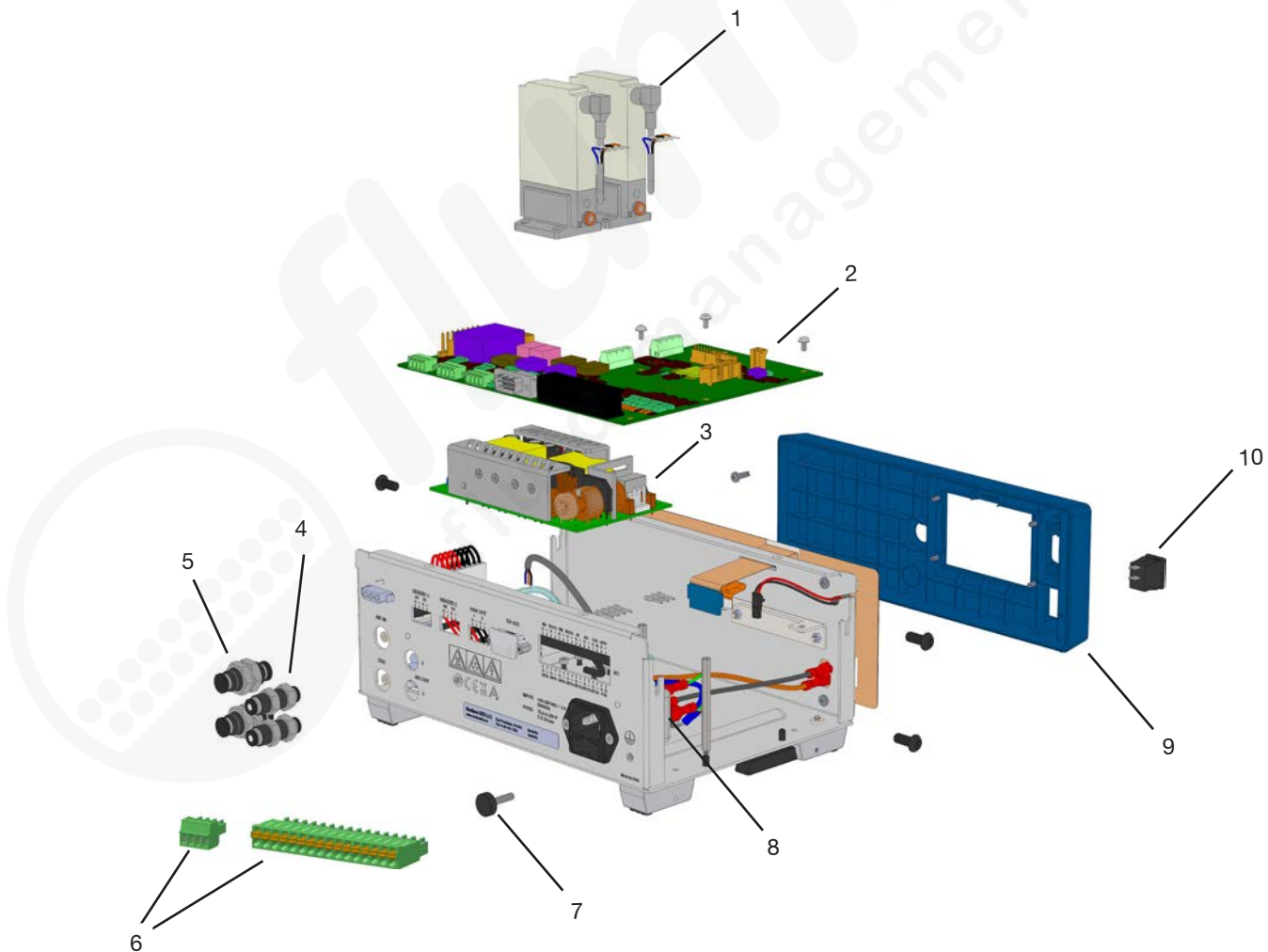

Troubleshooting

Problem	Possible Cause	Corrective Action
No power (blank display)	Blown fuse	Disconnect power to the unit and remove the fuse from the rear of the unit. Using a multi meter, check the resistance of the fuse. If the fuse is open, use the spare fuse provided.
	LCD backlight failed	With the unit plugged in and the power switched ON, closely inspect the LCD display. If characters are faintly visible, then the LCD backlight is no longer functional. Contact Nordson EFD. Adjust the display contrast. Refer to “Adjusting the LCD Contrast.”
DRV OUT not responding to an initiate signal (solenoid valve does not operate)	Controller disabled	Enable the controller by pressing and holding the ENABLE/DISABLE key  for 4 seconds until the controller is enabled.
	ON or OFF on DRIVERS screen set to 0.0000 (s)	Set ON or OFF to a non-zero value. Refer to “Setting Up the Driver Outputs.”
	DCNT on DRIVERS screen set to 0000	Set DCNT to a non-zero value. Refer to “Setting Up the Driver Outputs.”
	Foot pedal used and signal de-bounce disabled	Use the de-bounce operation (dbnc) serial command to enable foot pedal de-bounce. Refer to Appendix B, “RS-232C Connection Technical Information.”
	Problem with initiate signal integrity (Voltage Initiate)	Verify that the signal being used on the voltage initiate circuit is a clean, bounce-free signal (5–24 VDC).
	Incorrect VOLTS setting on the second DRIVERS screen	Set VOLTS to an appropriate value for the valve being used (for example, 24 V). Refer to “Setting Up the Driver Outputs.”
	More than one Voltage Initiate signal present	Verify that there is either a foot pedal or a voltage initiate signal present at one time. If these signals overlap, they can cancel the initiate signal.
	Current exceeded 1100 mA on the DRV OUT pins	Remove all connections to the DRV OUT pins, switch off the controller, and allow the controller to cool for 10 minutes.
	Problem with wiring integrity	Ensure that the wiring is correctly stripped and that the conductors are making contact with the screw terminal connector.
	Voltage Initiate applied to the wrong pins	Verify that the Voltage Initiate is applied to the pins corresponding to the desired DRV OUT output. Refer to “Setting Up the Driver Outputs.”
	Driver mode set to OFF on first DRIVERS screen	Set the DRIVERS mode to ON, PULS, or STDY. Refer to “Setting Up the Driver Outputs.”
	Flashing System Alarm IN	Remove or disable the system alarm. The unit will not initiate if there is an input alarm present. Refer to “Clearing an Alarm Input or Auto Increment Mode Alarm.”



Continued on next page

Troubleshooting (continued)

Problem	Possible Cause	Corrective Action
DRV OUT not responding to an initiate signal (solenoid valve does not operate) (continued)	Foot pedal initiate being used with de-bounce enabled for rapid initiate cycles	The foot pedal initiate circuit is de-bounced for a period of 20 ms because it is mainly intended to be used with mechanical switches. However, if both channels need to be initiated at faster rates, the de-bounce operation (dbnc) serial command can be used to disable the 20 ms de-bounce on the foot pedal. Refer to Appendix B, "RS-232C Connection Technical Information." The voltage initiate circuits, which are not de-bounced, can also be used.
	Auto Increment switched to memory cell with incorrect settings	Check the settings of all memory cells within the expected range. Refer to "Entering Memory Cell Settings" and "Setting Up the Auto Increment Mode."
ACT pressure reading and SET pressure value not the same	Insufficient input air pressure	Verify that the input air pressure is above the specified SET pressure.
	Controller's pressure regulators stabilizing or filling reservoir	Allow sufficient time for the pressure regulators to fill the reservoir.
	Controller requires pressure calibration	Verify the readings against a standard to confirm that they are not within specification, then perform a pressure calibration routine on the pressure channel in question.
No pressure on AIR OUT 1 or 2	Controller disabled	Enable the controller by pressing and holding the ENABLE/DISABLE key  for 4 seconds until the controller is enabled.
	MODE set to OFF on PRESSURE screen	Verify that the appropriate pressure channel MODE is set to ON. Refer to "Setting Up the Pressure Control."
	Tubing not fully engaged	The AIR OUT quick-connect fittings have a stop valve. Verify the correct and full engagement of the tubing connection to the quick-connect fitting to allow air flow.
	Flashing System Alarm IN	Remove or disable the system alarm. The controller switches off the pressure regulators if there is an input alarm present. Refer to "Clearing an Alarm Input or Auto Increment Mode Alarm."
Incorrect heater feedback	Incorrect thermocouple used	Verify that a J-type thermocouple is used.
	Incorrect wiring	Verify that wiring is connected to the J-type thermocouple as follows: TC+: Iron (Fe), white TC -: Constantan(Cu-Ni), red
	Broken thermocouple wire	Check the integrity of the thermocouple wiring.
	Thermocouple channels 1 and 2 swapped	Check the thermocouple wiring to ensure proper feedback for each channel.
	Problem with wiring integrity	Ensure that the wiring is correctly stripped and that the conductors are making contact with the screw terminal connector.

Continued on next page

Troubleshooting (continued)

Problem	Possible Cause	Corrective Action
Heater out not responding	System disabled	Enable the controller by pressing and holding the ENABLE/DISABLE key  for 4 seconds until the controller is ENABLED.
	MODE set to OFF on HEATERS screen	Verify that the appropriate heater channel MODE is set to ON. Refer to “Setting Up the Heater Control.”
	Flashing Heater Fault System Alarm	If the heater outputs shorted or an over-current condition occurred: Find the cause of the over-current condition, physically correct the problem, then clear the alarm. When a Heater Fault alarm occurs, both heaters immediately switch off. If a safety shutoff occurred: The heater actual reading was below its setpoint by 10 °C for longer than a minute, therefore triggering a Heater Fault System Alarm. Inspect the system and clear the alarm. When a Heater Fault alarm occurs, both heaters immediately switch off.
	Flashing TC Fault System Alarm	A thermocouple disconnect condition has occurred while the heater was ON. Verify the thermocouple wiring and integrity. When a TC Fault alarm occurs, both heaters immediately switch off. Clear the alarm to resume normal operation. Refer to “Clearing a Thermocouple (TC) Fault Alarm.”
	Problem with wiring integrity	Ensure that the wiring is correctly stripped and that the conductors are making contact with the screw terminal connector.
GPO not responding to a GPI initiate signal	System disabled	Enable the controller by pressing and holding the ENABLE/DISABLE key  for 4 seconds until the controller is enabled.
	MODE set to OFF on GENERAL PURPOSE IO screen	Verify that the appropriate GPIO channel MODE is set to ON. Refer to “Setting Up the General Purpose IOs.”
	TIME,DELY, ON, or OFF on GENERAL PURPOSE IO screen set to 0.0000 (s)	Set TIME,DELY, ON, and OFF to a non-zero value. Refer to “Setting Up the General Purpose I/Os.”
	Problem with initiate signal integrity (GPI)	Verify that the signal being used on the voltage initiate circuit is a clean, bounce-free signal.
	Problem with wiring integrity	Ensure that the wiring is correctly stripped and that the conductors are making contact with the spring terminal connector.
	Current exceeded 200 mA on GPO pins	Remove all connections to the GPO pins, switch off the controller, and allow the controller to cool for 10 minutes.
	Flashing System Alarm IN	Remove or disable the system alarm. The unit will not initiate if there is an input alarm present. Refer to “Clearing an Alarm Input or Auto Increment Mode Alarm.”
	Initiate applied to the wrong pins	Ensure that the initiate signal is applied to the same GPI channel as it is for the desired GPO channel.

Continued on next page

Troubleshooting (continued)

Problem	Possible Cause	Corrective Action
No output on the End-of-Cycle (EOC) pins	Current exceeded 100 mA on the (EOC) pins	Remove all connections to the EOC pins, switch off the controller, and allow the controller to cool for 10 minutes.
	Incorrect system wiring	Refer to the EOC schematic under "I/O Connector Schematics."
	Problem with wiring integrity	Ensure that the wiring is correctly stripped and that the conductors are making contact with the screw terminal connector.
No output on the Alarm Out (AO) pins	Current exceeded 100 mA on the AO pins	Remove all connections to the AO pins, switch off the controller, and allow the controller to cool for 10 minutes.
	Incorrect system wiring	Refer to the AO schematic under "I/O Connector Schematics."
	Problem with wiring integrity	Ensure that the wiring is correctly stripped and that the conductors are making contact with the screw terminal connector.
Computer unable to communicate with controller via RS-232C	Incorrect BAUD rate setting	Change the SET COM PORT baud rate setting. Refer to "Setting the RS-232C Baud Rate." The available baud rates are 9600, 9200, 38400, and 115200. Additional data: Start Bit:1 Data Length: 8 bit ASCII Parity bit: None Stop bit: 1
Dispense valve not actuating	Insufficient ON Time	Verify that the ON time settings are within the working range of the valve.
Unable to regulate Valve temperature	Heater control loop parameters not adjusted for a non-Nordson EFD valve	Contact Nordson EFD.

Appendix A, Connector Pin Technical Data

Heater Outputs

Pin Name	Signal Specifications	Description
HT1+	<ul style="list-style-type: none"> • 24 VDC • 25 W maximum • Resettable fuse • Overvoltage / reverse voltage protection • Maximum setpoint of 100° C (212° F) (adjustable) 	
HT1-	<ul style="list-style-type: none"> • Return path for HT1+ output 	
TC1+	<ul style="list-style-type: none"> • J-type thermocouple connection • Iron (Fe) 	Temperature control of the heaters is accomplished through the feedback provided by J-type thermocouples. The wire color is white.
TC1-	<ul style="list-style-type: none"> • J-type thermocouple connection • Constantan (Cu-Ni) 	The wire color is red.
HT2+	<ul style="list-style-type: none"> • Same as HT1+ 	
HT2-	<ul style="list-style-type: none"> • Return path for HT2+ output 	
TC2+	<ul style="list-style-type: none"> • Same as TC1+ 	
TC2-	<ul style="list-style-type: none"> • Same as TC1- 	

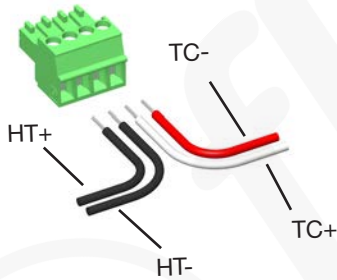

Appendix A, Connector Pin Technical Data (continued)

Driver Outputs

Pin Name	Signal Specifications	Description
DRV OUT 1+	<ul style="list-style-type: none"> • 24 W • 5–24 VDC • Resettable fuse • Reverse, overvoltage, and fly-back protection • <1 ms turn on and off time • 100 μs time resolution (adjustable) • Spike-and-hold • Adjustable spike duration of 20–250 ms (adjustable) • Hold voltage of 5–24 V (adjustable) 	The driver outputs are high-speed, high-power outputs intended to drive high-speed solenoid valves up to 500Hz.
DRV OUT 1-	<ul style="list-style-type: none"> • Return path for DRV1+ output 	
DRV OUT 2+	<ul style="list-style-type: none"> • Same as DRV1+ 	
DRV OUT 2-	<ul style="list-style-type: none"> • Same as DRV1- 	

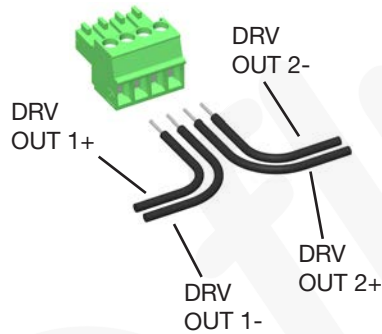

Appendix A, Connector Pin Technical Data (continued)

Foot Pedal Connector

- Foot pedal: dry contact initiate circuit, 19 mA closure current

NOTE: The foot pedal initiate signal is de-bounced for a period of 20 ms. To disable the de-bounce on the foot pedal signal, press the 5 key during power up or use the serial command through a serial cable (RS-232C).

Pin Name	Signal Specifications	Description
CC+	<ul style="list-style-type: none"> • Output from a 24 VDC source, 100 mA maximum, resettable fuse, and reverse polarity protected for connection to the foot switch CC- input. 	The CC signal pair senses a contact closure from a foot switch and initiates a dispense cycle of the enabled drivers. The contact closure can be momentary or maintained in a steady mode. A new cycle can be initiated by opening and the closing the contact again.
Chassis ground	<ul style="list-style-type: none"> • Connection from an EFD foot switch metal housing to the controller chassis. 	
CC-	<ul style="list-style-type: none"> • Contact Closure sense input, 5–24 VDC, 20 mA maximum, reverse polarity protected, 10 ms minimum pulse and not isolated. 	

Foot Pedal Connector Schematic

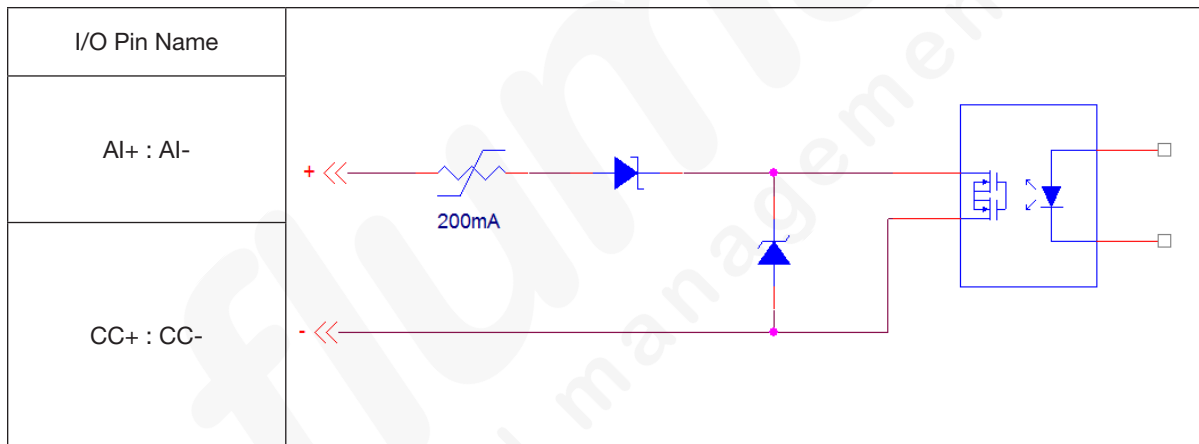

Appendix A, Connector Pin Technical Data (continued)

I/O Connector

Pin Name	Electrical Specification	Signal Description
VI1+	<ul style="list-style-type: none"> Isolated input 5–24 VDC 20 mA maximum 200 μs minimum pulse with reverse polarity protection 	The Voltage Initiate 1 signal triggers a dispense cycle for channel 1 when a 5–24 VDC signal is applied across the VI1+ and VI1- pins.
VI1-	<ul style="list-style-type: none"> Isolated return path for VI1+ input 	
EOC1+	<ul style="list-style-type: none"> Isolated output switch 5–24 VDC 100 mA maximum Resettable fuse Reverse polarity and transient overvoltage protection 	The End of Cycle 1 signal pair is an isolated electronic switch output. The switch opens during a channel 1 dispense cycle and closes when the cycle completes.
EOC1-	<ul style="list-style-type: none"> Isolated return path for EOC1+ output 	
VI2+	<ul style="list-style-type: none"> Isolated input 5–24 VDC 20 mA maximum 200 μs minimum pulse with reverse-polarity protection 	Refer to the VI1+ description.
VI2-	<ul style="list-style-type: none"> Isolated return path for the VI2+ input 	
EOC2+	<ul style="list-style-type: none"> Isolated output switch 5–24 VDC 100 mA maximum Resettable fuse Reverse polarity and transient overvoltage protected 	Refer to the EOC1+ description.
EOC2-	<ul style="list-style-type: none"> Isolated return path for the EOC2+ output 	
AI+	<ul style="list-style-type: none"> Output from a 24 VDC source 100 mA maximum Resettable fuse Reverse polarity-protected for connection to the AI- input 	The Alarm Input pin pair senses a closed circuit switch OPENING. When an AI open circuit is sensed, the controller will display the System Alarm screen and prevent any further dispense cycles from initiating. This signal can be disabled. Refer to “Setting Alarm Options.”
AI-	<ul style="list-style-type: none"> AI closure sense input 5–24 VDC 20 mA maximum reverse-polarity protected 10 ms minimum pulse, not isolated 	

Continued on next page

Appendix A, Connector Pin Technical Data (continued)

I/O Connector (continued)

Pin Name	Electrical Specification	Signal Description
AO+	<ul style="list-style-type: none"> Isolated output switch 5–24 VDC 100 mA maximum Resettable fuse Reverse polarity and transient overvoltage protected 	The Alarm Out signal pair is an isolated electronic switch output. The switch closes when an alarm condition occurs. The Alarm Out signal can be activated by any of the alarm conditions described above.
AO-	<ul style="list-style-type: none"> Isolated return path for AO+ output 	
PS1+	<ul style="list-style-type: none"> 24 VDC output source 100 mA maximum Resettable fuse Reverse polarity and transient overvoltage protected PS2+ output on pin 31 is a separate circuit 	The PS1+ and G1- pin pair provide 24 VDC, 100mA power for external wiring to I/O signals. This pin pair is not electrically isolated.
G1-	<ul style="list-style-type: none"> Ground return and reference for the PS1+ 24 VDC output source 	
GPI1+	<ul style="list-style-type: none"> Isolated input 5–24 VDC 20 mA maximum 1.5 ms minimum pulse with reverse-polarity protection 	The General Purpose Input 1 signal triggers General Purpose Output 1 when a 5–24 VDC signal is applied across the GPI1+ and GPI1- pins. This signal pair has reverse-polarity protection.
GPI1-	<ul style="list-style-type: none"> Isolated return path for GPI1+ input 	
GPI2+	<ul style="list-style-type: none"> Same as GPI1+ above 	Refer to the General Purpose Input 1 signal description.
GPI2-	<ul style="list-style-type: none"> Same as GPI1- above 	
GPI3+	<ul style="list-style-type: none"> Same as GPI1+ above 	Refer to the General Purpose Input 1 signal description.
GPI3-	<ul style="list-style-type: none"> Same as GPI1- above 	
GPI4+	<ul style="list-style-type: none"> Same as GPI1+ above 	Refer to the General Purpose Input 1 signal description.
GPI4-	<ul style="list-style-type: none"> Same as GPI1- above 	

Continued on next page

Appendix A, Connector Pin Technical Data (continued)

I/O Connector (continued)

Pin Name	Electrical Specification	Signal Description
GPO1+	<ul style="list-style-type: none"> Isolated output switch 5–24 VDC 200 mA maximum Resettable fuse Reverse polarity, overvoltage, and inductive transient protected 	The General Purpose Output 1 signal pair is an isolated electronic switch output. It may be turned on in response to a GPI1 input. The switch can be connected to inductive loads.
GPO1-	Isolated return path for GPO1+ switch	
GPO2+	<ul style="list-style-type: none"> Same as GPO1+ above 	Refer to the General Purpose Output 1 signal description.
GPO2-	<ul style="list-style-type: none"> Same as GPO1- above. 	
GPO3+	<ul style="list-style-type: none"> Same as GPO1+ above 	Refer to the General Purpose Output 1 signal description.
GPO3-	<ul style="list-style-type: none"> Same as GPO1- above 	
GPO4+	<ul style="list-style-type: none"> Same as GPO1+ above 	Refer to the General Purpose Output 1 signal description.
GPO4-	<ul style="list-style-type: none"> Same as GPO1- above 	
PS2+	<ul style="list-style-type: none"> 24 VDC output source 100 mA maximum Resettable fuse Reverse-polarity and transient overvoltage protected PS1+ output on pin 13 is a separate circuit 	The PS2+ and G2- pin pair provide 24 VDC, 100 mA power for external wiring to I/O signals. This pin pair is not electrically isolated.
G2-	<ul style="list-style-type: none"> Ground return and reference for the 24 VDC output 	

I/O Connector Schematics

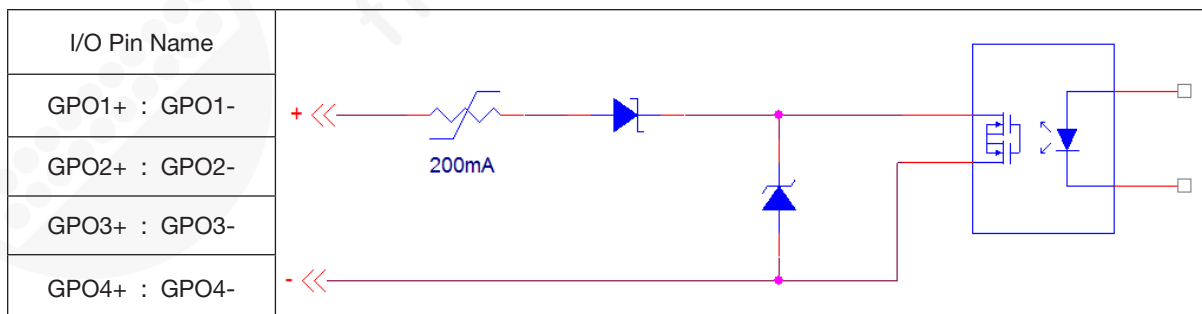

Appendix A, Connector Pin Technical Data (continued)

I/O Connector Schematics (continued)

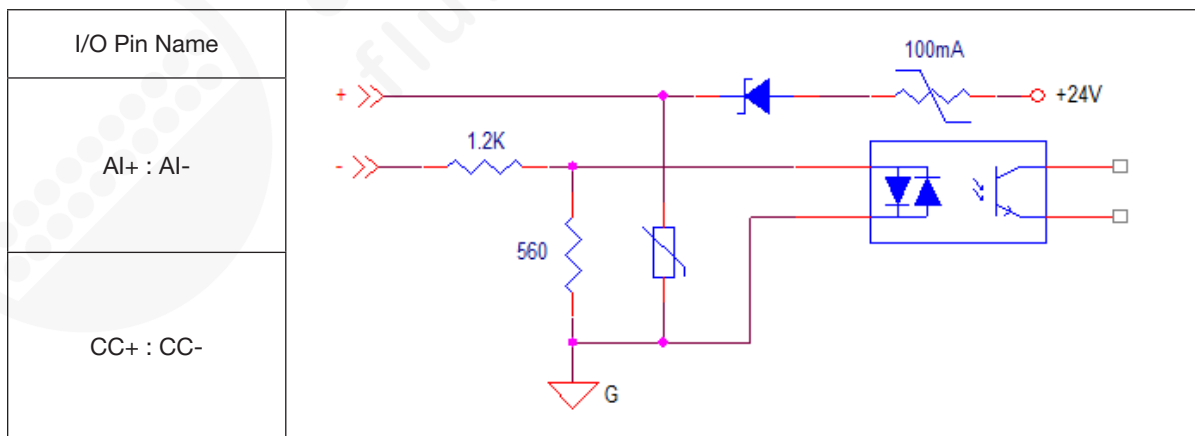
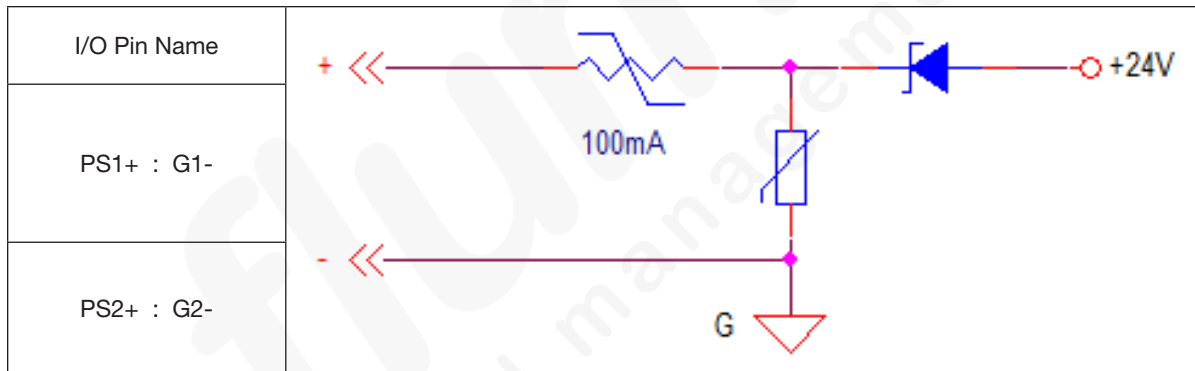
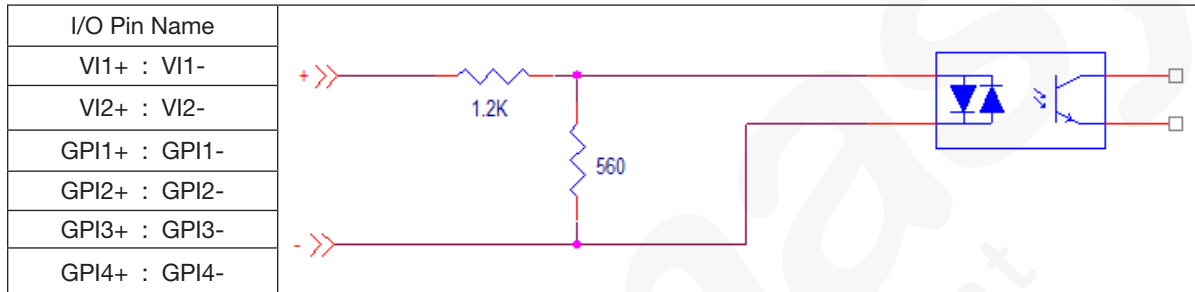
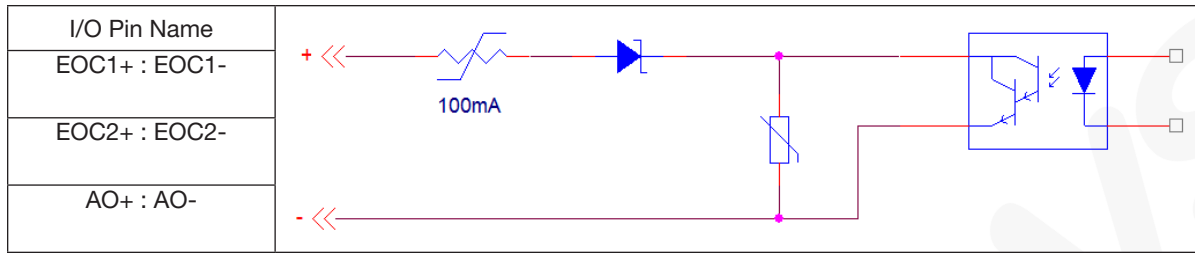

Appendix B, RS-232C Connection Technical Information

RS-232C Pins

Pin 2: RS-232_TX

The RS-232 TX pin transmits data from the ValveMate 9000 controller to an external communication device. Connect the RS-232 RX pin on the external communication device to this pin.

Pin 3: RS-232_RX

The RS-232 RX pin receives data from the external communication device into the ValveMate 9000 controller. Connect the RS-232 TX pin on the external communication device to this pin.

Pin 5: Common Ground

RS-232C Protocol

Communication Specifications

The RS-232C protocol for the ValveMate 9000 controller uses the RS-232C standard. The controller acts as a terminal to the remote host PC or PLC. The controller communicates using the following settings:

- Synchronous mode: half duplex
- Baud rates: 9600, 19200, 38400, 115200
- Start bit: 1
- Data length: 8 bit (ASCII)
- Parity bit: None
- Stop bit: 1

Communication Sequence

The host machine initiates all communication sequences. The controller echos all received characters.

The controller evaluates the last four characters in the command packet as the command.

Typical Command Packet: xxxCCCC

(where xxx is the setting and CCCC is the command)

The length of the setting varies depending on the command.

Commands are evaluated after a carriage return ([Enter] or 0x0D hex). After a carriage return is received, the controller evaluates the command, transmits any data related to the command, and closes the packet with <3.

Example: The host machine sends 0disk followed by a carriage return (0x0D). The ValveMate 9000 controller replies with Master Key OFF followed by <3 to terminate the command packet.

```
0disk [Enter]
Master Key OFF
<3
```

Appendix B, RS-232C Connection Technical Information (continued)

Communication Sequence (continued)

If the ValveMate 9000 controller does not recognize a command, it replies with <?.

For example:

```
0DISK [Enter]
<?
```

In this example, the controller did not recognize the command "0DISK" because all commands are case-sensitive.

RS-232C Commands

The following tables provide the RS-232C commands for the ValveMate 9000 controller. Each entry includes a brief description of the command, shows the command format, and provides a description of the data that is attached and retrieved by the command.

The commands are organized into the following groups:

- Main menu and main screen
- Temperature menu
- Pressure menu
- Driver menu
- General purpose I/O and I/O menus
- Specific alarms and auto increment
- Miscellaneous

NOTES:

- The <3 acknowledge command is removed from the examples since all commands are successfully evaluated.
- The return constant (the Enter key) is depicted as "[Enter]" in all examples.

Appendix B, RS-232C Connection Technical Information (continued)

Main Menu and Main Screen

Command	Description	Command Format	Sample with Output
Master Enable/ Disable	Enables or disables the controller, essentially mimicking the Enable/Disable key located on the front panel of the controller  ENABLE/DISABLE key	Host Format: <code>xdisk</code> <code>0disk</code> = Set controller to Disabled <code>1disk</code> = Set controller to Enabled <code>2disk</code> = Read back the status	<code>0disk [Enter]</code> Master Key OFF <code>1disk [Enter]</code> Master Key ON <code>2disk [Enter]</code>
Set RS-232 Baud Rate	Sets the baud rate of the controller NOTE: Adjust the COMM Port baud rate accordingly. Refer to "Setting the RS-232C Baud Rate".	Host format: <code>xbaud</code> <code>1</code> = 9600 <code>2</code> = 19200 <code>3</code> = 38400 <code>4</code> = 115200	<code>4baud [Enter]</code> BAUD RATE = 115200
Set Driver 1 Spike Time	Sets the spike duration (in ms) for driver channel 1	Host Format: <code>xxxspk1</code> <code>xxx</code> = 020–250 ms	<code>020spk1 [Enter]</code> Spike On Time = 020 msec
Set Driver 2 Spike Time	Sets the spike duration (in ms) for driver channel 2	Host Format: <code>xxxspk2</code> <code>xxx</code> = 020–250 ms	<code>020spk2 [Enter]</code> Spike On Time = 250 msec
Set Driver 1 Hold Voltage	Sets the hold voltage (5–24 V) for driver channel 1	Host Format: <code>xxvh11</code> <code>xx</code> = 05–24 volts	<code>19vh11 [Enter]</code> Hold Voltage = 19 Volts
Set Driver 2 Hold Voltage	Sets the hold voltage (5–24 V) for driver channel 2	Host Format: <code>xxvh12</code> <code>xx</code> = 05–24 volts	<code>19vh12 [Enter]</code> Hold Voltage = 08 Volts
Set Memory Cell Location	Sets the current memory cell location for the controller	Host Format: <code>xxsmem</code> <code>xx</code> = 00–99 (valid memory cell range)	<code>55smem [Enter]</code> Memory Cell Set = 55
Set Auto Increment Start Memory Cell Location	Sets the start memory cell location used during Auto Increment Mode	Host Format: <code>xxstrt</code> <code>xx</code> = 00–99 (valid memory cell range)	<code>05strt [Enter]</code> Start Memory Address Set = 05
Set Auto Increment End Memory Cell Location	Sets the end memory cell location used during Auto Increment Mode	Host Format: <code>xxsend</code> <code>xx</code> = 00–99 (valid memory cell range)	<code>20send [Enter]</code> End Memory Address Set = 20
Set Auto Increment Mode Trigger value	Sets the trigger value used during Auto Increment Mode	Host Format: <code>xxxstrg</code> <code>xxxx</code> = 0000–9999	<code>3030strg [Enter]</code> Trigger Set = 3030
MAIN Screen Feedback	Returns the current main screen settings of the controller	Host Format: <code>rman</code>	<code>rman [Enter]</code> STRT = 05 END = 20 MEM = 05 TRIG = 3030 CNT = 0000

Appendix B, RS-232C Connection Technical Information (continued)

Temperature Menu

Command	Description	Command Format	Sample with Output
Set Units of Temperature	Sets the temperature units for the controller to Celsius or Fahrenheit	Host Format: xstmp 0stmp = Degrees Celsius 1stmp = Degrees Fahrenheit	0stmp [Enter] Temperature Unit = C 1stmp [Enter] Temperature Unit = F
Set Heater Channel 1 Mode	Sets the mode of operation for heater 1	Host Format: xhtr1 0htr1 = Disable the Channel 1htr1 = Enable the Channel 2htr1 = Read back the status ON/OFF	0htr1 [Enter] Heater Channel: 1 OFF 1htr1 [Enter] Heater Channel: 1 ON 2htr1 [Enter] Heater Channel: 1 ON
Set Heater Channel 2 Mode	Sets the mode of operation for heater 2	Host Format: xhtr2 0htr2 = Disable the channel 1htr2 = Enable the channel 2htr2 = Read back the status ON/OFF	0htr2 [Enter] Heater Channel: 2 OFF 1htr2 [Enter] Heater Channel: 2 ON 2htr2 [Enter] Heater Channel: 2 ON
Set Heater Channel 1 Temperature	Sets the heater temperature for heater 1	Host Format: DDSht1 Where DDD is the desired temperature in degrees Celsius or Fahrenheit	070sht1 [Enter] Set Temperature = 70 °C
Set Heater Channel 2 Temperature	Sets the heater temperature for heater 2	Host Format: DDSht2 Where DDD is the desired temperature in degrees Celsius or Fahrenheit	080sht2 [Enter] Set Temperature = 80 °C
Heater Channel 1 Feedback	Returns the current settings for heater 1	Host Format: rht1	rht1 [Enter] MEM = 00 MODE = ON SET = 32F ACT = ---F
Heater Channel 2 Feedback	Returns the current settings for heater 2	Host Format: rht2	rht2 [Enter] MEM = 00 MODE = ON SET = 27F ACT = ---F

Appendix B, RS-232C Connection Technical Information (continued)

Pressure Menu

Command	Description	Command Format	Sample with Output
Set Units of Pressure	Sets the pressure units of the controller to psi, bar, or kpa	Host Format: <i>xsprs</i> <i>0sprs</i> = Set the pressure units to psi <i>1sprs</i> = Set the pressure units to bar <i>2sprs</i> = Set the pressure units to kpa	<i>0sprs</i> [Enter] Pressure Unit = psi <i>1sprs</i> [Enter] Pressure Unit = bar <i>2sprs</i> [Enter] Pressure Unit = kpa
Set Pressure Channel 1 Mode	Sets the mode of operation for pressure channel 1	Host Format: <i>xopr1</i> <i>0opr1</i> = Disable Channel 1 <i>1opr1</i> = Enable Channel 1 <i>2opr1</i> = Read back the status ON/OFF	<i>0opr1</i> [Enter] Pressure Channel: 1 OFF <i>1opr1</i> [Enter] Pressure Channel: 1 ON <i>2opr1</i> [Enter] Pressure Channel: 1 ON
Set Pressure Channel 2 Mode	Sets the mode of operation for pressure channel 2	Host Format: <i>xopr2</i> <i>0opr2</i> = Disable Channel 2 <i>1opr2</i> = Enable Channel 2 <i>2opr2</i> = Read back the status ON/OFF	<i>0opr2</i> [Enter] Pressure Channel: 2 OFF <i>1opr2</i> [Enter] Pressure Channel: 2 ON <i>2opr2</i> [Enter] Pressure Channel: 2 ON
Set Pressure Channel 1 Setpoint	Sets pressure channel 1 to the desired pressure in psi	Host Format: <i>DDD.Dspr1</i> Where <i>DDD.D</i> is the desired pressure in psi (pressure units must be set to psi)	<i>040.1spr1</i> [Enter] Set Pressure = 040.1psi
Set Pressure Channel 2 Setpoint	Sets pressure channel 2 to the desired pressure in psi	Host Format: <i>DDD.Dspr2</i> Where <i>DDD.D</i> is the desired pressure in psi (pressure units must be set to psi)	<i>060.8spr2</i> [Enter] Set Pressure = 060.8psi
Pressure Channel 1 Feedback	Returns the current settings for pressure channel 1	Host Format: <i>tpr1</i>	<i>tpr1</i> [Enter] MEM = 00 MODE = OFF SET = 040.1p ACT = 000.0p
Pressure Channel 2 Feedback	Returns the current settings for pressure channel 2	Host Format: <i>tpr2</i>	<i>tpr2</i> [Enter] MEM = 00 MODE = OFF SET = 060.8p ACT = 000.0p

Appendix B, RS-232C Connection Technical Information (continued)

Driver Menu

Command	Description	Command Format	Sample with Output
Set Driver 1 Mode	Sets the mode of operation for Driver 1	Host Format: xdrv1 0drv1 = Set the driver to OFF 1drv1 = Set the driver to ON 2drv1 = Set the driver to PULS 3drv1 = Set the driver to STDY 4drv1 = Reads back the status (OFF/ON/PULSE/STDY)	0drv1 [Enter] Driver 1: OFF 1drv1 [Enter] Driver 1: ON 2drv1 [Enter] Driver 1: PULS 3drv1 [Enter] Driver 1: STDY 4drv1 [Enter] Driver 1: STDY
Set Driver 2 Mode	Sets the mode of operation for Driver 2	Host Format: xdrv2 0drv2 = Set the driver to OFF 1drv2 = Set the driver to ON 2drv2 = Set the driver to PULS 3drv2 = Set the driver to STDY 4drv2 = Reads back the status (OFF/ON/PULSE/STDY)	0drv2 [Enter] Driver 2: OFF 1drv2 [Enter] Driver 2: ON 2drv2 [Enter] Driver 2: PULS 3drv2 [Enter] Driver 2: STDY 4drv2 [Enter] Driver 2: STDY
Set Driver 1 Spike and Hold Mode	Enables or disables the spike-and-hold (SpHld) functionality of Driver 1	Host Format: xhld1 0hld1 = Set spike and hold mode to OFF 1hld1 = Set spike and hold mode to ON	0hld1 [Enter] Driver 1 Spike and Hold is OFF 1hld1 [Enter] Driver 1 Spike and Hold is ON
Set Driver 2 Spike and Hold Mode	Enables or disables the spike-and-hold (SpHld) functionality of Driver 2	Host Format: xhld2 0hld2 = Set spike and hold mode to OFF 1hld2 = Set spike and hold mode to ON	0hld2 [Enter] Driver 2 Spike and Hold is OFF 1hld2 [Enter] Driver 2 Spike and Hold is ON

Continued on next page

Appendix B, RS-232C Connection Technical Information (continued)

Driver Menu (continued)

Command	Description	Command Format	Sample with Output
Set Driver 1 Voltage	Sets the voltage of Driver 1 (05–24 volts)	Host Format: <code>xxsvt1</code> Where <code>xx</code> is the voltage (VOLTS), with a valid range of 05–24 volts	<code>10svt1 [Enter]</code> Set Driver 1 Volt = 10V
Set Driver 2 Voltage	Sets the voltage of Driver 2 (05–24 volts)	Host Format: <code>xxsvt2</code> Where <code>xx</code> is the voltage (VOLTS), with a valid range of 05–24 volts	<code>15svt2 [Enter]</code> Set Driver 2 Volt = 15V
Set Driver 1 Dispense Count	Sets the dispense count (DCNT) for Driver 1 (0000–9999)	Host Format: <code>xxxxdcn1</code> Where <code>xxxx</code> is the desired dispense count, with a valid range of 0000–9999	<code>4567dcn1 [Enter]</code> Dispense Count (DCNT) = 4567
Set Driver 2 Dispense Count	Sets the dispense count (DCNT) for Driver 2 (0000–9999)	Host Format: <code>xxxxdcn2</code> Where <code>xxxx</code> is the desired dispense count, with a valid range of 0000–9999	<code>7890dcn2 [Enter]</code> Dispense Count (DCNT) = 7890
Set Driver 1 ON Time	Sets the ON Time for Driver 1	Host Format: <code>x.xxxxont1</code> Where <code>x.xxxx</code> is the desired time value, with a valid range of 0.0000–9.9999	<code>0.0010ont1 [Enter]</code> Time Set To = 0.0010 seconds
Set Driver 2 ON Time	Sets the ON Time for Driver 2	Host Format: <code>x.xxxxont2</code> Where <code>x.xxxx</code> is the desired time value, with a valid range of 0.0000–9.9999	<code>0.1584ont2 [Enter]</code> Time Set To = 0.1584 seconds
Set Driver 1 OFF Time	Sets the OFF Time for Driver 1	Host Format: <code>x.xxxxoft1</code> Where <code>x.xxxx</code> is the desired time value with, a valid range of 0.0000–9.9999	<code>0.1000oft1 [Enter]</code> Time Set To = 0.1000 seconds
Set Driver 2 OFF Time	Sets the OFF Time for Driver 2	Host Format: <code>x.xxxxoft2</code> Where <code>x.xxxx</code> is the desired time value with, a valid range of 0.0000–9.9999	<code>9.4513oft2 [Enter]</code> Time Set To = 9.4513 seconds
Driver 1 Feedback	Returns the current settings for driver channel 1	Host Format: <code>rdr1</code>	<code>rdr1 [Enter]</code> MEM = 00 MODE = OFF ON TIME = 0.0010 OFF TIME = 0.1000 DCNT = 4567 Spike and Hold = ON Volts = 10 Count = 00882648
Driver 2 Feedback	Returns the current settings for driver channel 2	Host Format: <code>rdr2</code>	<code>rdr2 [Enter]</code> MEM = 00 MODE = OFF ON TIME = 0.1584 OFF TIME = 9.4513 DCNT = 7890 Spike and Hold = ON Volts = 15 Count = 00450498

Appendix B, RS-232C Connection Technical Information (continued)

General Purpose I/O and I/O Menus

Command	Description	Command Format	Sample with Output
Set GPIO 1 Mode	Sets the operational mode for GPIO 1	Host Format: xgpi1 0gpi1 = Set GPIO 1 to OFF 1gpi1 = Set GPIO 1 to ON 2gpi1 = Set GPIO 1 to STDY 3gpi1 = Set GPIO 1 to CYCL 4gpi1 = Reads back the status of GPIO 1 (OFF/ON/STDY/CYCL)	0gpi1 [Enter] GPIO 1: OFF 1gpi1 [Enter] GPIO 1: ON 2gpi1 [Enter] GPIO 1: STDY 3gpi1 [Enter] GPIO 1: CYCL 4gpi1 [Enter] GPIO 1: CYCL
Set GPIO 2 Mode	Sets the operational mode for GPIO 2	Host Format: xgpi2 0gpi2 = Set GPIO 2 to OFF 1gpi2 = Set GPIO 2 to ON 2gpi2 = Set GPIO 2 to STDY 3gpi2 = Set GPIO 2 to CYCL 4gpi2 = Reads back the status of GPIO 2 (OFF/ON/STDY/CYCL)	0gpi2 [Enter] GPIO 2: OFF 1gpi2 [Enter] GPIO 2: ON 2gpi2 [Enter] GPIO 2: STDY 3gpi2 [Enter] GPIO 2: CYCL 4gpi2 [Enter] GPIO 2: CYCL
Set GPIO 3 Mode	Sets the operational mode for GPIO 3	Host Format: xgpi3 0gpi3 = Set GPIO 3 to OFF 1gpi3 = Set GPIO 3 to ON 2gpi3 = Set GPIO 3 to STDY 3gpi3 = Set GPIO 3 to CYCL 4gpi3 = Reads back the status of GPIO 3 (OFF/ON/STDY/CYCL)	0gpi3 [Enter] GPIO 3: OFF 1gpi3 [Enter] GPIO 3: ON 2gpi3 [Enter] GPIO 3: STDY 3gpi3 [Enter] GPIO 3: CYCL 4gpi3 [Enter] GPIO 3: CYCL
Set GPIO 4 Mode	Sets the operational mode for GPIO 4	Host Format: xgpi4 0gpi4 = Set GPIO 4 to OFF 1gpi4 = Set GPIO 4 to ON 2gpi4 = Set GPIO 4 to STDY 3gpi4 = Set GPIO 4 to CYCL 4gpi4 = Reads back the status of GPIO 4 (OFF/ON/STDY/CYCL)	0gpi4 [Enter] GPIO 4: OFF 1gpi4 [Enter] GPIO 4: ON 2gpi4 [Enter] GPIO 4: STDY 3gpi4 [Enter] GPIO 4: CYCL 4gpi4 [Enter] GPIO 4: CYCL

Continued on next page

Appendix B, RS-232C Connection Technical Information (continued)

General Purpose I/O and I/O Menus (continued)

Command	Description	Command Format	Sample with Output
Set GPIO 1 TIME or ON Settings	Sets the TIME or ON (if in CYCL mode) parameters for GPIO 1 to the desired setting	Host Format: xx.xxxong1 Where xx.xxx is the desired time setting, with a range of 00.001–99.999 seconds	02.125ong1 [Enter] Set Time = 02.125 seconds
Set GPIO 2 TIME or ON Settings	Sets the TIME or ON (if in CYCL mode) parameters for GPIO 2 to the desired setting	Host Format: xx.xxxong2 Where xx.xxx is the desired time setting, with a range of 00.001–99.999 seconds	99.854ong2 [Enter] Set Time = 99.854 seconds
Set GPIO 3 TIME or ON Settings	Sets the TIME or ON (if in CYCL mode) parameters for GPIO 3 to the desired setting	Host Format: xx.xxxong3 Where xx.xxx is the desired time setting, with a range of 00.001–99.999 seconds	45.451ong3 [Enter] Set Time = 45.451 seconds
Set GPIO 4 TIME or ON Settings	Sets the TIME or ON (if in CYCL mode) parameters for GPIO 4 to the desired setting	Host Format: xx.xxxong4 Where xx.xxx is the desired time setting, with a range of 00.001–99.999 seconds	00.050ong4 [Enter] Set Time = 00.050 seconds
Set GPIO 1 DELAY or OFF Settings	Sets the DELY or OFF (if in CYCL mode) parameters for GPIO 1 to the desired setting	Host Format: xx.xxxofg1 Where xx.xxx is the desired time setting, with a range of 00.001–99.999 seconds	13.846ofg1 [Enter] Set Time = 13.846 seconds
Set GPIO 2 DELAY or OFF Settings	Sets the DELY or OFF (if in CYCL mode) parameters for GPIO 2 to the desired setting	Host Format: xx.xxxofg2 Where xx.xxx is the desired time setting, with a range of 00.001–99.999 seconds	88.974ofg2 [Enter] Set Time = 88.974 seconds
Set GPIO 3 DELAY or OFF Settings	Sets the DELY or OFF (if in CYCL mode) parameters for GPIO 3 to the desired setting	Host Format: xx.xxxofg3 Where xx.xxx is the desired time setting, with a range of 00.001–99.999 seconds	66.579ofg3 [Enter] Set Time = 66.579 seconds
Set GPIO 4 DELAY or OFF Settings	Sets the DELY or OFF (if in CYCL mode) parameters for GPIO 4 to the desired setting	Host Format: xx.xxxofg4 Where xx.xxx is the desired time setting, with a range of 00.001–99.999 seconds	33.984ofg4 [Enter] Set Time = 33.984 seconds
GPIO 1 Feedback	Retrieves the current setup parameters for GPIO 1	Host Format: rgp1	rgp1 [Enter] GPIO 1 Mode: CYCL TIME: 02.125 DELAY: 13.846
GPIO 2 Feedback	Retrieves the current setup parameters for GPIO 2	Host Format: rgp2	rgp2 [Enter] GPIO 2 Mode: ON TIME: 99.854 DELAY: 88.974
GPIO 3 Feedback	Retrieves the current setup parameters for GPIO 3	Host Format: rgp3	rgp3 [Enter] GPIO 3 Mode: OFF TIME: 45.451 DELAY: 66.679
GPIO 4 Feedback	Retrieves the current setup parameters for GPIO 4	Host Format: rgp4	rgp4 [Enter] GPIO 4 Mode: STDY TIME: 00.050 DELAY: 33.984

Appendix B, RS-232C Connection Technical Information (continued)

Specific Alarms and Auto Increment

Command	Description	Command Format	Sample with Output
Set Pressure Alarm Range	Sets the pressure alarm range for pressure channels 1 and 2	Host Format: xxpalr Where xx has a working range of 01–10 psi	04palr [Enter] Pressure Alarm Range = 04 psi
Set Pressure Alarm Delay	Sets the pressure alarm delay for pressure channels 1 and 2	Host Format: xxpald Where xx has a working range of 00–99 seconds	12pald [Enter] Pressure Alarm Delay = 12 seconds
Set Heater Alarm Range	Sets the heater alarm range for heater channels 1 and 2	Host Format: xxhalr Where xx has a working range of 01–10 degrees	03halr [Enter] Heater Alarm Range = 03 °F
Set Heater Alarm Delay	Sets the heater alarm delay for heater channels 1 and 2	Host Format: xxhald Where xx has a working range of 00–99 minutes	12hald [Enter] Heater Alarm Delay = 12 minutes
Set Auto Increment Mode	Sets the mode of operation for Auto Increment mode	Host Format: xaimd 0aimd = Set Auto Increment mode to OFF 1aimd = Set Auto Increment mode to Time 2aimd = Set Auto Increment mode to Count 3aimd = Set Auto Increment mode to Sequence	0aimd [Enter] AutoIncrement MODE = OFF 1aimd [Enter] AutoIncrement MODE = TIME 2aimd [Enter] AutoIncrement MODE = COUNT 3aimd [Enter] AutoIncrement MODE = SEQ
Set Auto Increment Mode SYNC	Links the Auto Increment mode to the corresponding channel	Host Format: xaisy 0aisy = SYNC Auto Increment mode to Channel 1 1aisy = SYNC Auto Increment mode to Channel 2	0aisy [Enter] AutoIncrement SYNC = Ch 1 1aisy [Enter] AutoIncrement SYNC = Ch 2
Set Auto Increment Alarm	Enables or disables the Auto Increment Alarm	Host Format: xaial 0aial = Auto Increment Alarm Disabled 1aial = Auto Increment Alarm Enabled 2aial = Auto Increment Alarm Feedback	0aial [Enter] Auto Increment ALARM OFF 1aial [Enter] Auto Increment ALARM ON

Continued on next page

Appendix B, RS-232C Connection Technical Information (continued)

Specific Alarms and Auto Increment (continued)

Command	Description	Command Format	Sample with Output
Set Unit Alarms	Enables or disables the different alarm settings for the controller	Host Format: 012345alrm 0 = Input Alarm Enable (0 disable / 1 Enable) 1 = Input Alarm Latch (0 disable / 1 Enable) 2 = Pressure Alarm Enable (0 disable / 1 Enable) 3 = Pressure Alarm Latch (0 disable / 1 Enable) 4 = Heater Alarm Enable (0 disable / 1 Enable) 5 = Heater Alarm Latch (0 disable / 1 Enable)	000000alrm [Enter] Alarm Settings successful 101010alrm [Enter] Alarm Settings successful
Feedback Alarm Settings	Reads the current alarm settings	Host Format: falr	falr [Enter] Alarm Status: 1= Enabled 0=Disabled 0 Enable Input Alarm 0 Latch Input Alarm 0 Enable Pressure Alarm 0 Latch Pressure Alarm 0 Enable Heater Alarm 0 Latch Heater Alarm
Set Heater Fault Time	Sets the Heater Fault Time used to trip a Heater Fault Alarm	Host Format: DDDhtft Where DDD is the desired time setting in seconds	059htft [Enter] Heater Fault Time=059

Miscellaneous

Command	Description	Command Format	Sample with Output
De-bounce Operation	Enables or disables the de-bounce option on foot pedal initiate signals	Host Format: xdbnc 0dbnc = Disable system de-bounce on the foot pedal initiate signals 1dbnc = Enable system de-bounce on the foot pedal initiate signals	1dbnc [Enter] ****F/S Debounce ON **** 0dbnc [Enter] ****F/S Debounce OFF ****
System Information	Returns the firmware version of the ValveMate 9000 controller	Host Format: info	info [Enter] 7028693-VM 9000 V:001.001 1/1/14
System Reboot	Performs a soft reboot	Host Format: boot	boot [Enter]

Appendix C, Driver Spike-and-Hold Technical Data

With certain types of high speed valves, such as the Square Wave 745NC 24 W valve, it is necessary to throttle down the voltage once the valve is opened. Failure to reduce the voltage will result in permanent damage to the actuation solenoid if the valve is left on longer than 30 ms. To prevent damage to the actuation solenoid, the ValveMate 9000 controller provides a spike-and-hold functionality. When properly set, the spike-and-hold functionality allows the controller to spike the voltage for a user-specified spike time (DRV SPIKE TIME) and then throttle the voltage down to a user-specified hold voltage (DRV HOLD VOLTS) after the spike time expires. The graph on the next page shows how the spike-and-hold functions when the controller settings for Driver 1 are as follows:

On the DRIVERS screens:

MODE: ON
ON: 0.1000
OFF: 0.1000
DCNT: 0004
SpHld: ON
VOLTS: 24

```

DRIVERS
MEM : 00   ENABLED
DRIVER 1   DRIVER 2
MODE: ON   MODE: ON
ON : 0.1000 ON : 0.5000
OFF: 0.1000 OFF: 0.5000
DCNT: 0004 DCNT: 0001
<MAIN     MAIN     EPR>
  
```

Typical driver settings when spike-and-hold is set up (DRIVERS screen, page 1)

```

DRIVERS
MEM : 00   ENABLED ▲
DRIVER 1   DRIVER 2
SPHld: ON   SPHld: OFF
VOLTS: 24V  VOLTS: 12V
SHOT CNT:   SHOT CNT:
00026698   00046710
<MAIN     MAIN     EPR>
  
```

Typical driver settings when spike-and-hold is set up (DRIVERS screen, page 2)

On the DRIVER SETTINGS screen:

DRV1 HOLD VOLTS: 05V
DRV1 SPIKE TIME: 020ms

```

DRIVER SETTINGS
DRV1 HOLD VOLTS: 05V
DRV1 SPIKE TIME: 020ms
DRV2 HOLD VOLTS: 15V
DRV2 SPIKE TIME: 215ms
SAVE   CANCEL
  
```

Typical driver settings when spike-and-hold is set up (DRIVER SETTINGS screen)

Appendix C, Driver Spike-and-Hold Technical Data (continued)

Scope Plot of the Spike-and-Hold Functionality

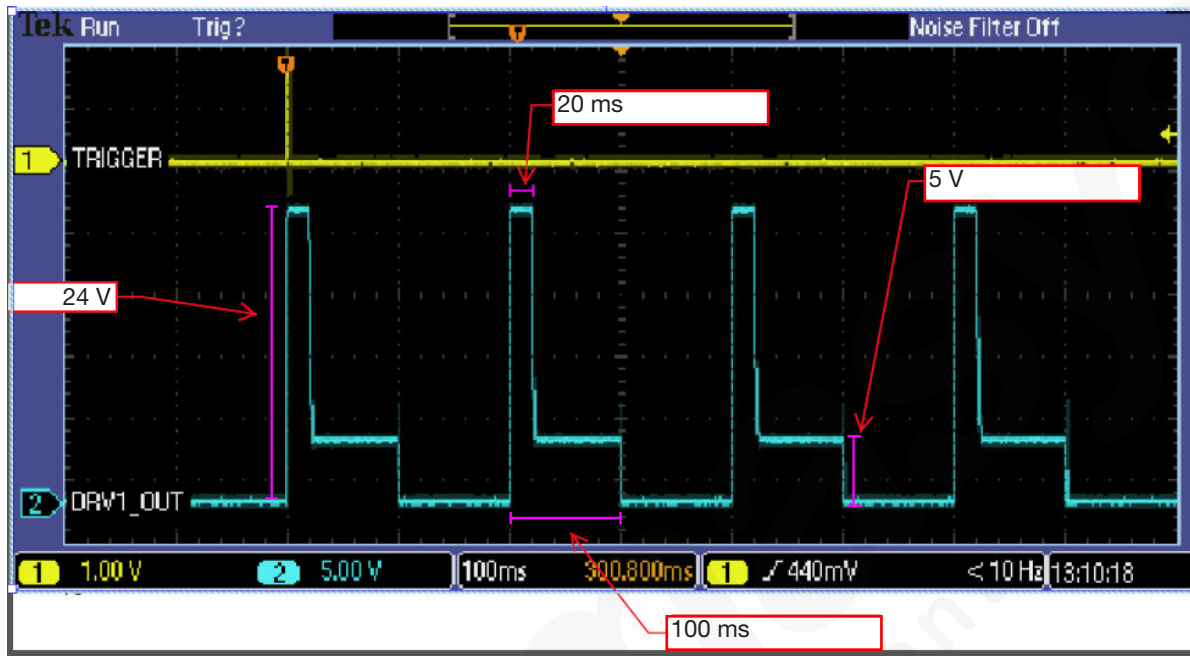

Appendix D, Settings Stored in Memory Cells

Drivers

- Mode 1
- Mode 2
- ON Time 1
- ON Time 2
- OFF Time 1
- OFF Time 2
- Spike and Hold Mode 1
- Spike and Hold mode 2
- Driver Voltage 1
- Driver Voltage 2
- Dispense Count (DCNT) 1
- Dispense Count (DCNT) 2

Heaters

- Mode 1
- Mode 2
- Temperature Setting 1
- Temperature Setting 2

Pressure

- Mode 1
- Mode 2
- Set Pressure 1
- Set Pressure 2

GPIO

- Mode 1
- Mode 2
- Time (ON) 1
- Time (ON) 2
- Time (ON) 3
- Time (ON) 4
- Delay (OFF) 1
- Delay (OFF) 2
- Delay (OFF) 3
- Delay (OFF) 4

Trigger

- Auto Increment Mode
- Trigger



flummasys
fluid management

NORDSON EFD ONE YEAR LIMITED WARRANTY

All components of the Nordson EFD ValveMate 9000 are warranted for one year from date of purchase to be free from defects in material and workmanship (but not against damage caused by misuse, abrasion, corrosion, negligence, accident, faulty installation or by dispensing material incompatible with equipment) when the equipment is installed and operated in accordance with factory recommendations and instructions. EFD will repair or replace free of charge any part of the equipment thus found to be defective, on authorized return of the part prepaid to our factory during the warranty period.

In no event shall any liability or obligation of EFD arising from this warranty exceed the purchase price of the equipment. This warranty is valid only when oil-free, clean, dry, filtered air is used.

Nordson EFD makes no warranty of merchantability or fitness for a particular purpose. In no event shall EFD be liable for incidental or consequential damages.

